

**ebm-papst St. Georgen GmbH & Co. KG**

Hermann-Papst-Str. 1

D-78112 St. Georgen

Phone +49 (0) 7724 81-0

info2@de.ebmpapst.com

www.ebmpapst.com

Nominal data

Item	8550 N	
Motor	-0	
Phase		1~
Nominal voltage	VAC	230
Frequency	Hz	50
Speed (rpm)	min ⁻¹	2700
Power consumption	W	12.0
Min. ambient temperature	°C	-10
Max. ambient temperature	°C	70
Air flow	m ³ /h	50
Sound power level	B	4.4
Sound pressure level	dB(A)	30

ml = Max. load · me = Max. efficiency · fa = Free air · cs = Customer specification · ce = Customer equipment
Subject to change

Technical description

Weight	0.490 kg
Dimensions	80 x 80 x 38 mm
Impeller material	Sheet steel, painted black
Housing material	Die-cast aluminum
Airflow direction	Exhaust over struts
Service life L10 at 40 °C	52500 h
Service life L10 at maximum temperature	25000 h

Product drawing

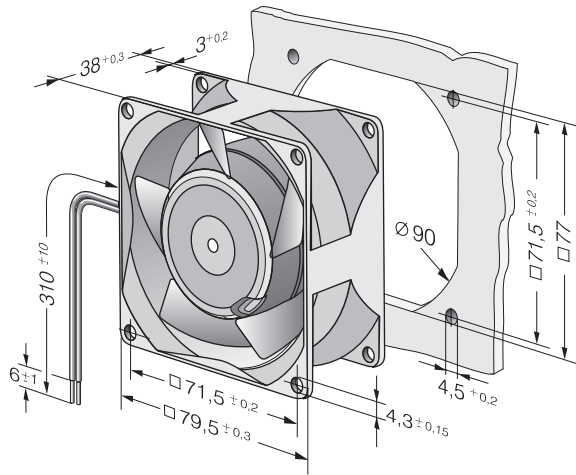

Curves: Air performance

