

DESCRIPTION

The MP26121 is a linear, high-performance single cell Li-Ion/Li-Polymer battery charger. By integrating high voltage input protection into the charger IC, the MP26121 can tolerate an input surge up to +28V.

The device features constant current (CC) and constant voltage (CV) charging modes with programmable charge currents (200mA to 1A), current blocking, and trickle charge. The device also provides fault and charge status indications to the system.

For guaranteed safe operation, the MP26121 reduces charge current when the device reaches high temperature (due to limited PCB space). Other safety features include battery temperature monitoring and programmable timer to complete the charging cycle.

The MP26121 is available in a QFN-10 (3mmx3mm) package.

FEATURES

- Interfaces to Many NTC Resistor Values
- Proprietary V_{IN} Surge Protection up to 28V
- Programmable Charge Current up to 1A
- 1% Voltage Accuracy
- 10% Battery-Full Threshold
- No Reverse Blocking Diode Required
- Intelligent Thermal Management
- Trickle Charge
- 7V Input OVP
- Auto Recharge
- Charge-Timer
- Fault and Charge Status Indicators

APPLICATIONS

- Cell Phones
- Digital Cameras
- Smart Phones
- PDAs
- MP3 Players

"MPS" and "The Future of Analog IC Technology" are Registered Trademarks of Monolithic Power Systems, Inc.

TYPICAL APPLICATION

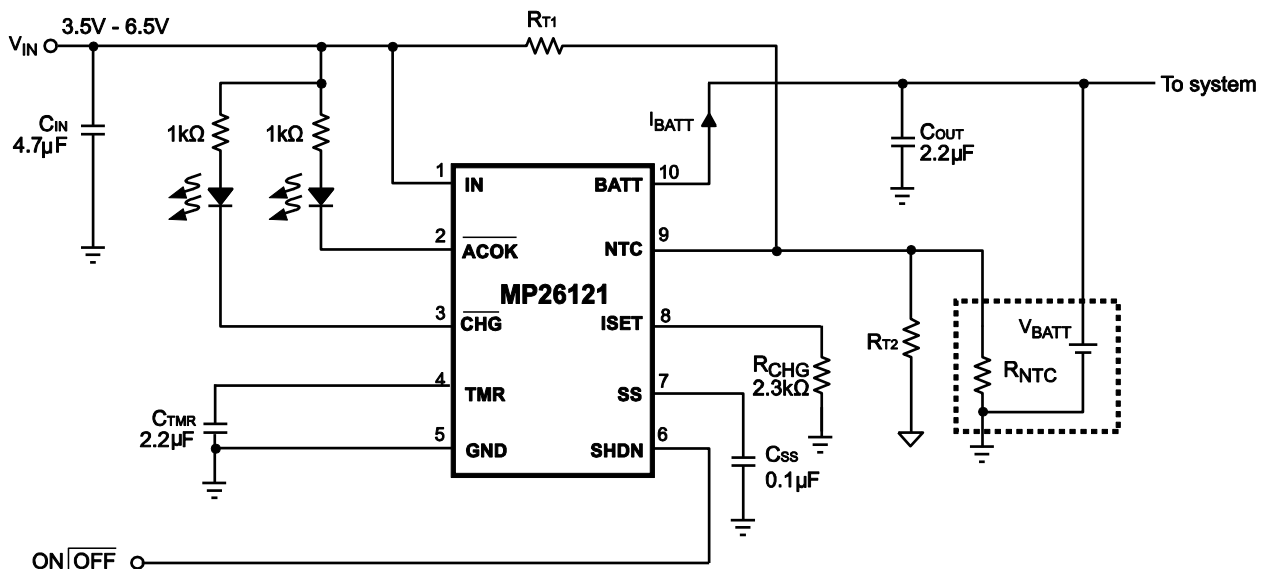

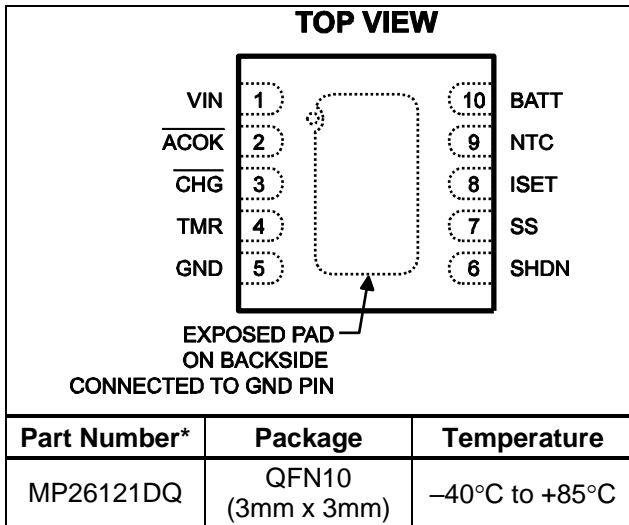
PACKAGE REFERENCE

* For Tape & Reel, add suffix -Z (e.g. MP26121DQ-Z)
 For RoHS compliant packaging, add suffix -LF
 (e.g. MP26121DQ-LF-Z)

ABSOLUTE MAXIMUM RATINGS (1)

IN to GND -5V to +28V
 ACOK and CHG Maximum Sink Current.....20mA
 All Other Pins to GND.....-0.3V to +6.5V
 Junction Temperature..... 140°C
 Lead Temperature260°C
 Storage Temperature-65°C to +150°C

Recommended Operating Conditions (2)

Nominal Supply Voltage V_{IN} 3.5V to 6.5V
 Operating Temperature-40°C to +85°C

Thermal Resistance (3)

θ_{JA} θ_{JC}
 3x3 QFN10 50 12... °C/W

Notes:

- 1) Exceeding these ratings may damage the device.
- 2) The device is not guaranteed to function outside of its operating conditions.
- 3) Measured on approximately 1" square of 1 oz copper. The exposed pad must be Soldered to a ground plane

ELECTRICAL CHARACTERISTICS

$V_{IN} = 5V$, $V_{SHDN} = 0V$, $T_A = +25°C$, unless otherwise noted.

Parameter	Symbol	Condition	Min	Typ	Max	Units
Supply Current	I_{SUPPLY}	SHDN = high		40		μA
		SHDN = low, $I_{CHG} = 0A$, $V_{BATT} = 4.1V$		200		μA
Battery Voltage Regulation	V_{BATT}	$T = -5°C$ to $+75°C$, $I_{BATT} = 100mA$	4.16	4.20	4.24	V
Constant Current Regulation	I_{CHG}	$V_{IN} = 5V$, $V_{BATT} = 3.8V$ $R_{CHG} = 3.3k\Omega$	448	515	582	mA
Constant Current Variation		$V_{IN} = 5V$, $V_{BATT} = 3.8V$, $T_J = 0°C$ to $+120°C$, $R_{CHG} = 1.6k\Omega$ to $8.0k\Omega$	87	100	113	% $I_{CHG}^{(4)}$
End of Charge Threshold	I_{BF}		7	10	13	% $I_{CHG}^{(4)}$
Trickle Current		$V_{IN} = 5V$, $V_{BATT} = 2.3V$	5	10	15	% $I_{CHG}^{(4)}$
Trickle Threshold Voltage			2.45	2.6	2.75	V
Trickle Voltage Hysteresis				100		mV
Input \overline{ACOK} Up Range			6.7	7	7.3	V
Input \overline{ACOK} Low Range			1.5	2	2.5	V
\overline{ACOK} and \overline{CHG} Over-voltage Clamp	V_Z			7.4		V
Input Over Voltage Protection	OVP	V_{IN} rising	6.7	7	7.3	V
OVP Hysteresis				400		mV

ELECTRICAL CHARACTERISTICS *(continued)*

$V_{IN} = 5V$, $V_{SHDN} = 0V$, $T_A = +25^{\circ}C$, unless otherwise noted.

Parameter	Symbol	Condition	Min	Typ	Max	Units
SHDN Trip Threshold High			2.6			V
SHDN Trip Threshold Low					0.4	V
SHDN Pull up Current	I_{SHDN}	$V_{SHDN} = 3V$		6		μA
\overline{CHG} , \overline{ACOK} Sink Current		Pin voltage = 0.4V	8			mA
Battery Reverse Current to BATT Pin		SHDN = low, input = floating or 0V			1	μA
Dropout Voltage	$V_{IN}-V_{BATT}$	$V_{BATT} = 3.8V$, $R_{CHG} = 6k\Omega$, current drop 10%		0.25		V
Die Temperature Limit			105	120	135	$^{\circ}C$
Recharge Voltage Threshold	$V_{RECHARGE}$		3.9	4.0	4.1	V
Recharge Voltage Hysteresis				100		mV
NTC Upper Threshold	V_{NTC_UP}	$V_{IN} = 5V$, NTC pin voltage rising		2.735		V
NTC Upper Trip Hysteresis				75		mV
NTC Lower Threshold	V_{NTC_LOW}	$V_{IN} = 5V$, NTC pin voltage falling		1.197		V
NTC Lower Trip Hysteresis				20		mV
Oscillation Freq		$C_{TMR} = 2.2\mu F$		5.4		Hz
TMR Pin Source Current	I_{TMR1}	$V_{TMR} = 0.1V$		20		μA
TMR Pin Sink Current	I_{TMR2}	$V_{TMR} = 1.5V$		20		μA
Soft Start Time		From trickle to 90% full current, $C_{SS} = 0.1\mu F$		80		mS

Notes:

4) I_{CHG} is the target preprogrammed charge current (Die temperature below 110°C).

PIN FUNCTIONS

Pin #	Name	Description
1	VIN	Input Supply Pin. VIN receives the AC adapter or USB supply voltage.
2	ACOK	Open-Drain Fault Status Indicator. This pin is high under any fault conditions.
3	CHG	Open-Drain Charge Indicator. This pin is low during charging, is high after battery full or termination, and is toggling when the battery is in fault condition.
4	TMR	Oscillator Period Timer. Connect a timing capacitor between this pin and GND to set the oscillator period.
5	GND, Exposed Pad	The exposed pad and GND pin must be connected to the same ground plane.
6	SHDN	Charger IC Enable. An input “Low” signal at this pin or pin floating will enable the IC.
7	SS	Soft-Start. Connect a capacitor to ground to set the soft-start time.
8	ISET	Constant Charge Current Program Pin. Connect this pin to an external resistor to program the charging current in CC Mode.
9	NTC	Negative Temperature Coefficient (NTC) Thermistor Pin. Connect a resistor R_{T1} from this pin to VIN pin and a resistor R_{T2} from this pin to GND in parallel with the NTC resistor (within the battery pack). If NTC function is not used, apply $R_{T2}=1/2 R_{T1}$. Do not leave this pin floating.
10	BATT	Charger Output.

BLOCK DIAGRAM

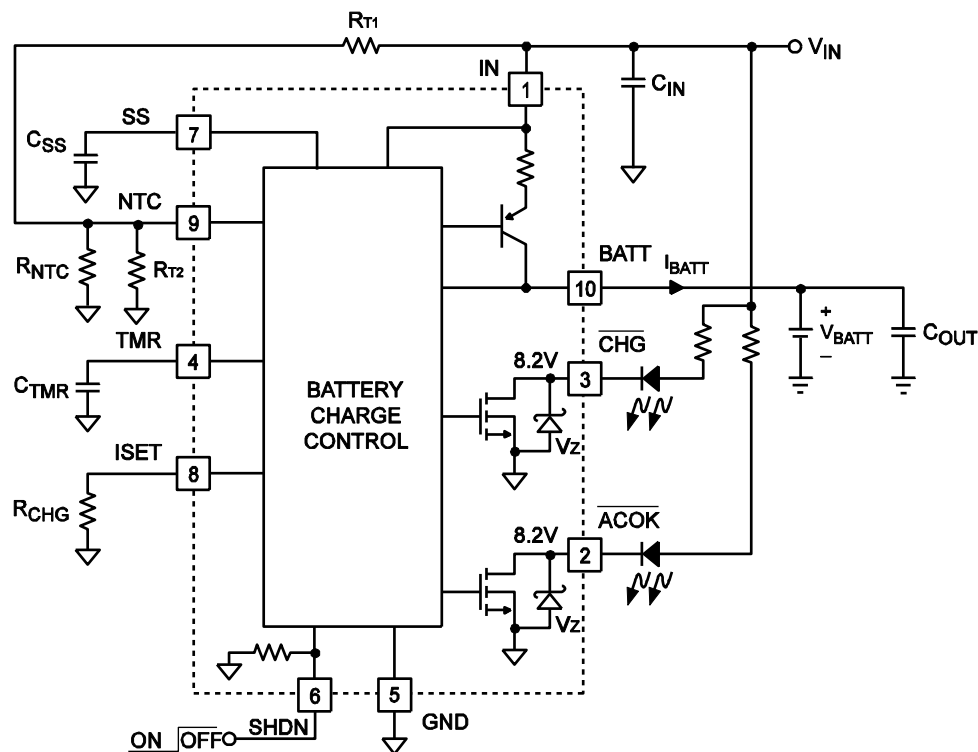
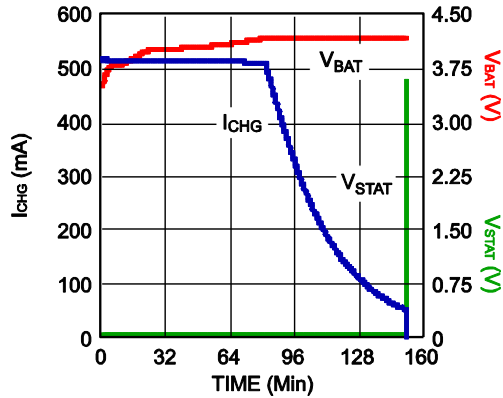

Figure 1—Functional Block Diagram

TYPICAL PERFORMANCE CURVES

$C_{IN} = 4.7\mu F$, $C_{OUT} = 2.2\mu F$, $C_{SS} = 0.1\mu F$, $V_{IN} = 5V$, $T_A = +25^\circ C$, unless otherwise noted.

Battery Charge Curve



Charge Current vs Battery Voltage

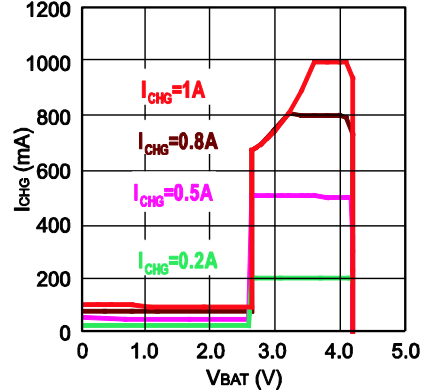

Charge Current vs Battery Voltage

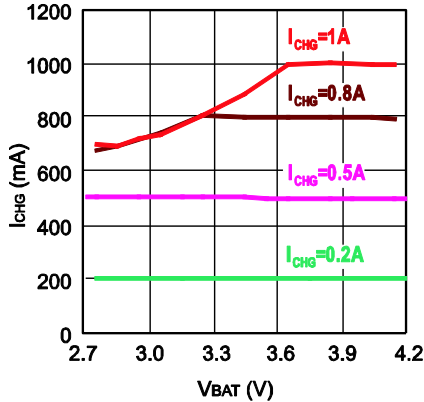

I_{CHG} Current vs Input Voltage

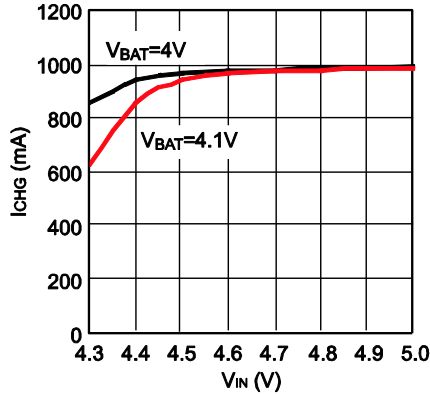

1/RSET vs. ISET

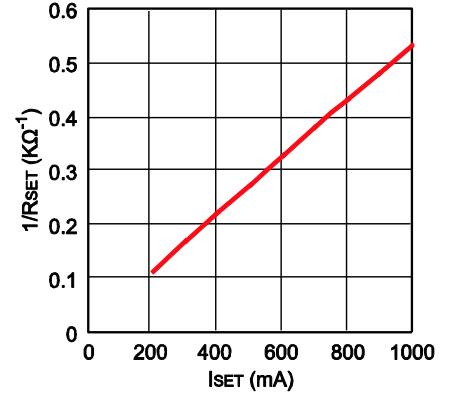

Shutdown Low

$V_{IN} = 5V$, I_{SET} resistor = 2.26k Ω

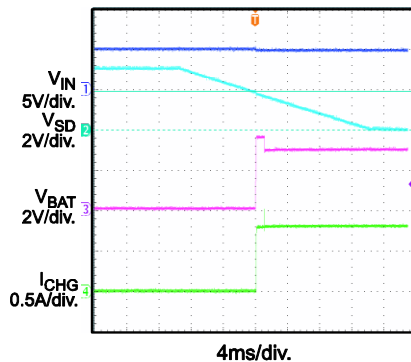

Shutdown High

$V_{IN} = 5V$, I_{SET} resistor = 2.26k Ω , $V_{BAT} = 3.8V$

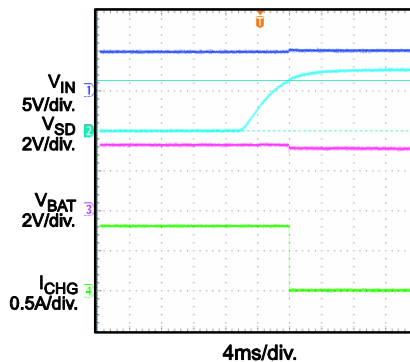

Power Ramps Up vs. Battery Charge

$V_{IN} = 5V$, I_{SET} resistor = 2.3k Ω

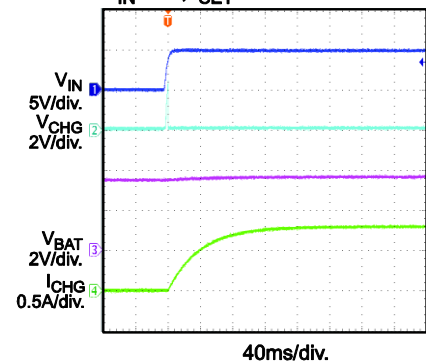

TYPICAL PERFORMANCE CURVES (continued)

$C_{IN} = 4.7\mu F$, $C_{OUT} = 2.2\mu F$, $C_{SS} = 0.1\mu F$, $V_{IN} = 5V$, $T_A = +25^\circ C$, unless otherwise noted.

Power Ramps Down vs. Battery Charge

$V_{IN} = 5V$, I_{SET} resistor = $2.3k\Omega$

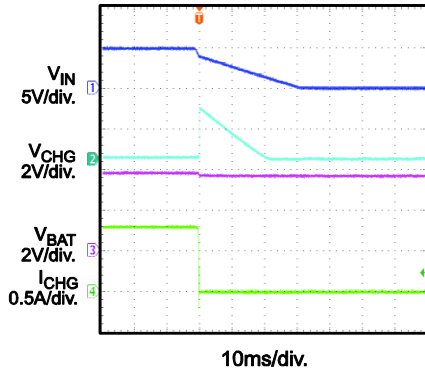

Charge Full Terminated

$V_{IN} = 5V$, $I_{CHG} = 0.5A$

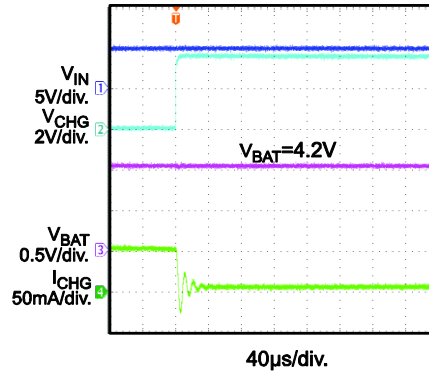

Terminated to Re-Charge

$V_{IN} = 5V$, $I_{CHG} = 0.5A$

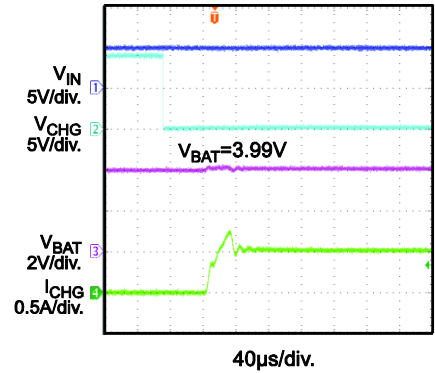

NTC Window

$V_{IN} = 5V$, $I_{CHG} = 0.8A$

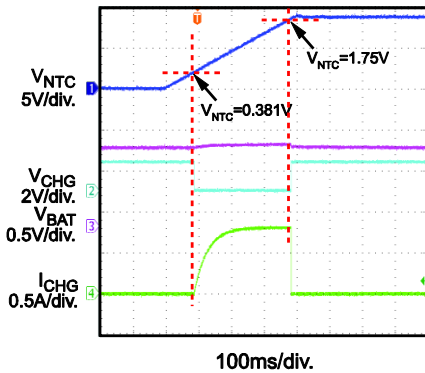

ACOK and CHG Internal Zener Diode Characteristics

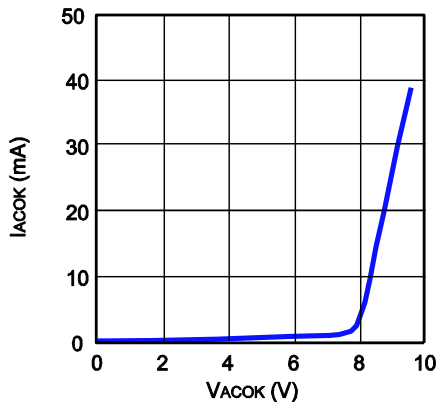

Voltage Charge vs. Temperature

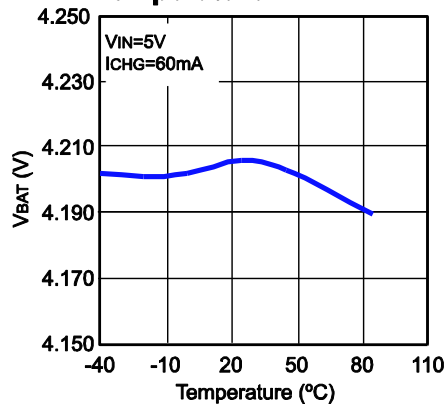

Current Charge vs. Temperature

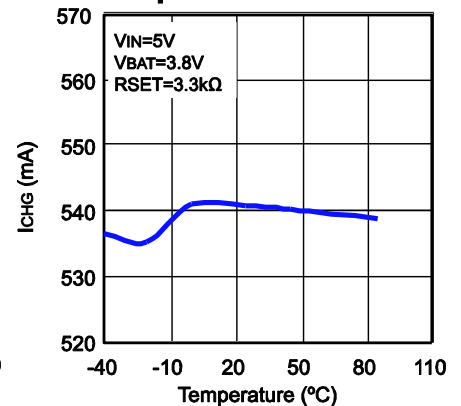

OPERATION

Input Voltage Range

The MP26121 has built-in input voltage surge protection as high as +28V. The charger IC will be automatically disabled when the input voltage is lower than 3V or higher than 7V. The open-drain pin \overline{ACOK} is used to indicate an input power good condition (e.g. $3V < V_{IN} < 7V$). If the input voltage is lower than the battery voltage, the IC is also disabled to prevent the battery from draining.

Charge Cycle (Mode Change: Trickle -> CC-> CV)

Figure 2 shows the typical charging profile for the MP26121. For a fully depleted battery with a terminal voltage lower than 2.6V, the MP26121 will start with the trickle charge (preconditioning) at 10% of the full charge current based on the value of R_{CHG} . If the charger stays in trickle mode longer than 32768 cycles, \overline{CHG} becomes high impedance, indicating a battery fault. After the battery voltage reaches 2.6V, the charger begins charging using the programmed charge current (I_{CHG}). This is referred to as Constant Current (CC) mode. Once the battery voltage reaches 4.2V, the charger will operate in the constant voltage (CV) mode until the battery is fully charged. The charge current drops during CV mode, and the battery full indication is set when the charge current is reduced to 10% of the programmed constant current value (I_{CHG}). The charge process is then terminated. Recharge will start after the battery voltage is reduced to 4.0V. After 262144 cycles of continuous charging, if the battery still has not reached 10% of the I_{CHG} condition, the on-chip timer will terminate the charger to prevent charging the dead battery excessively and the fault condition will be flagged by flashing the \overline{CHG} LED.

Charge Termination

The charge current will gradually decrease in CV mode as the battery approaches full. The

battery full threshold is internally programmed to be 10% of the I_{CHG} . When the charge current reaches this threshold, the charger IC will be automatically turned off.

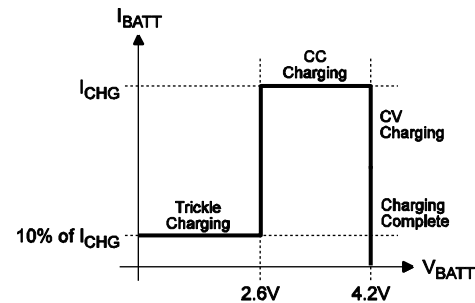

Figure 2—MP26121 Typical Charging Profile

Automatic Recharge

When V_{BATT} drops to 4.0V, the charger will automatically restart the charge cycle until the 10% I_{CHG} condition is met again. When the input adapter is unplugged, or the charger is disabled and/or terminated, the leakage current from the battery to the MP26121 is less than 1 μ A.

Programming of Charge Current and Battery Full Current

The charge current (I_{CHG}) is set by a resistor (R_{CHG}) connected from the ISET pin to GND. The relationship between the charge current and the programming resistance is established by the following table and graph.

Table 1— R_{CHG} and I_{CHG} Relationship

R_{CHG} (k Ω)	I_{CHG} (mA)
1.65	1000
1.82	900
2.05	800
2.32	700
2.74	600
3.3	500
4.12	400
5.6	300
8.45	200
15	100

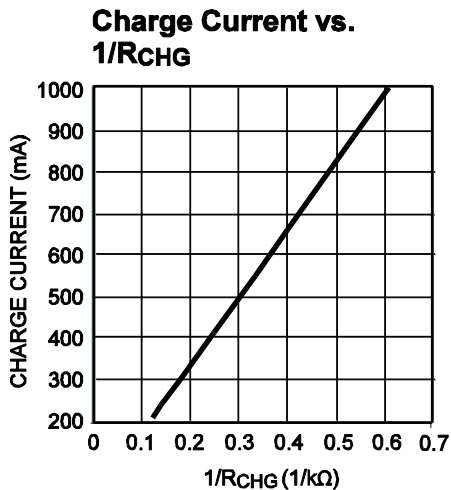

Figure 3—Charge Current vs. 1/R_{CHG} Resistance

The recommended resistance for programming the charge current is $2.3\text{k}\Omega < R_{\text{CHG}} < 11\text{k}\Omega$. The open-drain pin $\overline{\text{CHG}}$ is used to indicate charging status. When the battery full condition is met or any other condition prevents the charger from charging, $\overline{\text{CHG}}$ will become a floating pin.

Charger Status Indication

	SHDN = High Vin Fault	Battery Full	Time out Fault	Ambient Temperature Fault	In Charging
$\overline{\text{CHG}}$	HIGH	HIGH	Toggle	HIGH	LOW

$\overline{\text{ACOK}}$ is LOW while $3\text{V} < V_{\text{IN}} < 7\text{V}$, otherwise it is HIGH.

Negative Thermal Coefficient (NTC) Thermistor

The MP26121 has a built-in NTC resistance window comparator. If configured as the typical application circuit as indicated in Figure 1, the MP26121 can fit most types of NTC resistors with two extra programming resistors.

R_{T1} and R_{T2} values depend on the type of NTC:

$$R_{\text{T2}} = \frac{0.308 \times R_{\text{NTCH}} \times R_{\text{NTCL}}}{0.108 \times R_{\text{NTCL}} - 0.416 \times R_{\text{NTCH}}}$$

$$R_{\text{T1}} = 0.828 \times (R_{\text{T2}} // R_{\text{NTCL}})$$

For example, for the EWTF03-103 J31 H NTC resistor, the valid charging temperature range is from 0°C to 50°C. The MP26121 will cease charging if $R_{\text{NTC}} < 4.161\text{k}\Omega$ or $R_{\text{NTC}} > 27.285\text{k}\Omega$ with $R_{\text{T1}} = 11.536\text{k}\Omega$ and $R_{\text{T2}} = 28.554\text{k}\Omega$.

Timer Operation

The TMR pin is used to set the internal oscillator frequency, $F_{\text{OSC}} = 11.9\text{Hz} \times \frac{\mu\text{F}}{C_{\text{TMR}}}$. The

on-chip timer will start to count down after initial power-up or every time it is enabled. This timer will limit the max trickle-charge time to 32768 internal oscillating cycles. If the charger stays in trickle mode for longer than 32768 cycles, it will be terminated and a fault will be set by floating $\overline{\text{CHG}}$ pin. After fault reporting, the charger can be re-initiated only by recycling the power supply or SHDN signal. If the charger successfully goes through trickle charge within the allowed time limit, it will start CC charging and then CV charging. If the total charge time exceeds 262144 cycles and the battery full has not been qualified, the charger will be terminated and a fault will also be set by flashing $\overline{\text{CHG}}$ pin at the rate of half the internal oscillation frequency. This function prevents charging a dead battery for prolonged duration. The timer function can be disabled by shorting TMR to ground.

Thermal Protection

The MP26121 has proprietary thermal protection to prevent the IC from overheating. When in thermal protection mode, the average charge current will be reduced to prevent the IC from overheating. Operating in thermal protection mode will slow down the charging process. Lowering the input voltage and enhancing thermal dissipation to the environment can effectively prevent the IC from going into thermal protection mode.

Under full charge conditions, certain systems may draw a very narrow current pulse that exceeds the IBF threshold. The $\overline{\text{CHG}}$ indicator may glitch. It is desirable to blank the $\overline{\text{CHG}}$ glitch

so that the system can properly indicate full charge conditions to the user. A simple solution is to add a RC filter on the $\overline{\text{CHG}}$ pin to filter out the possible $\overline{\text{CHG}}$ glitch, as shown in Figure 4.

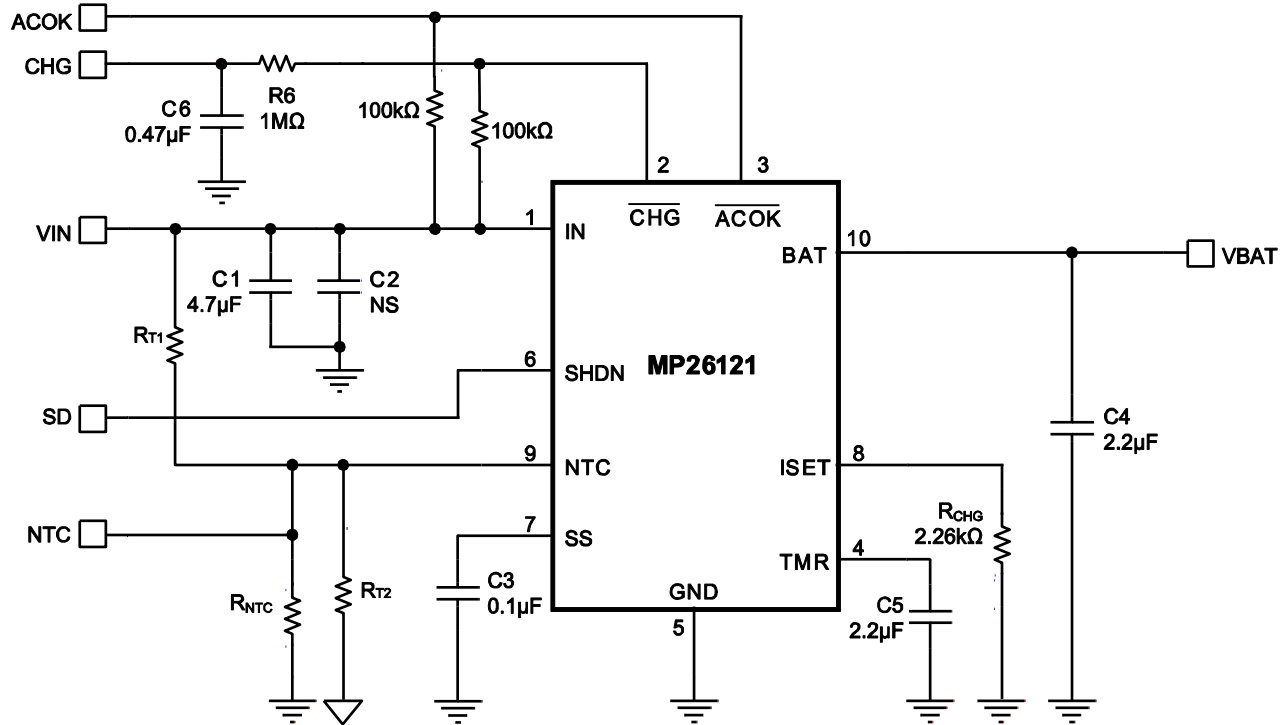

Figure 4—Filtered Charge Status with GPIO Connection

Power-On Reset (POR) feature can be applied to the MP26121 to ensure that the device starts operating in a known state. The flow chart in Figure 5 describes the conditions and operation

modes of the MP26121. CVC and CCC stand for “constant voltage charge” and “constant current charge”, respectively.

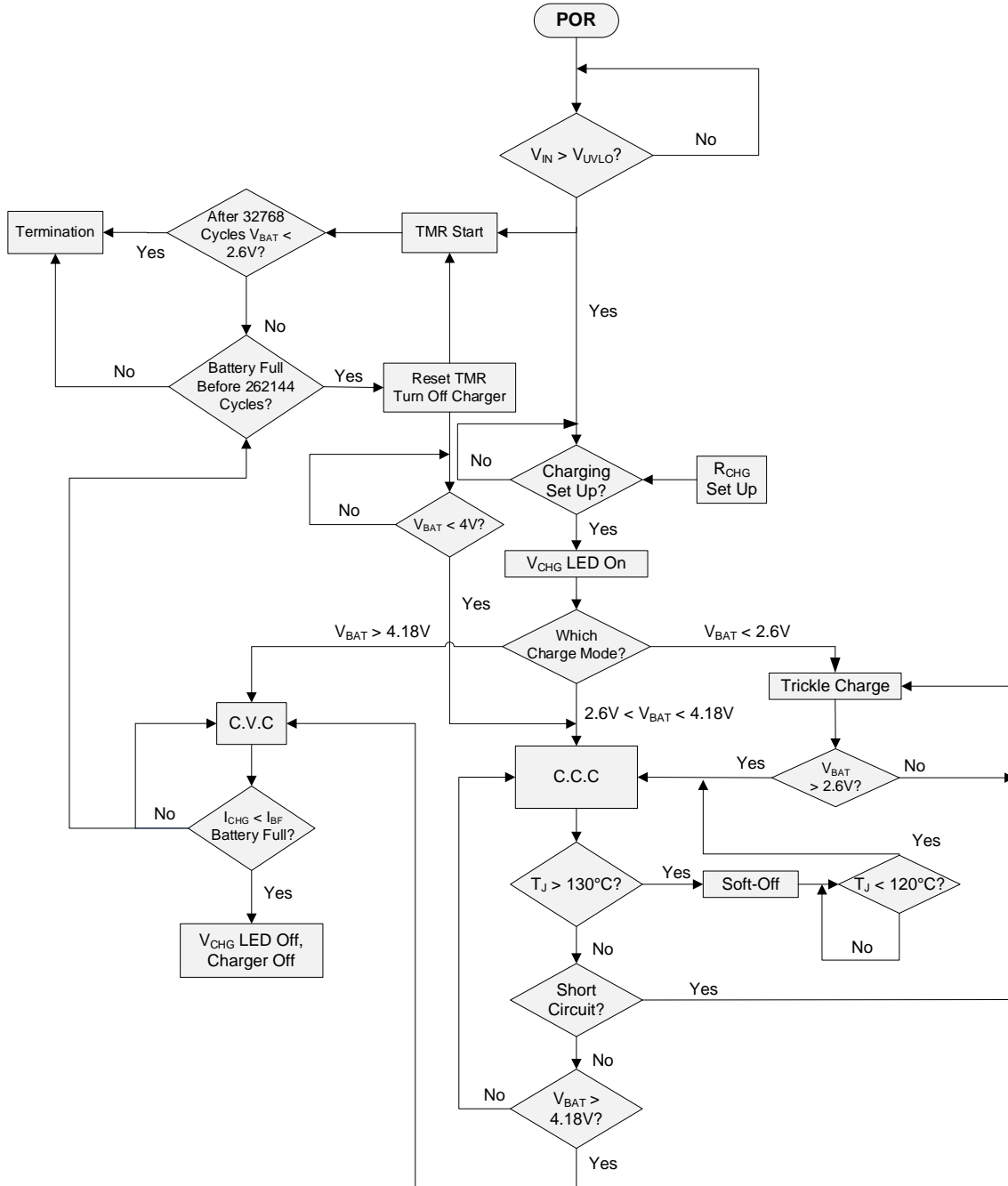
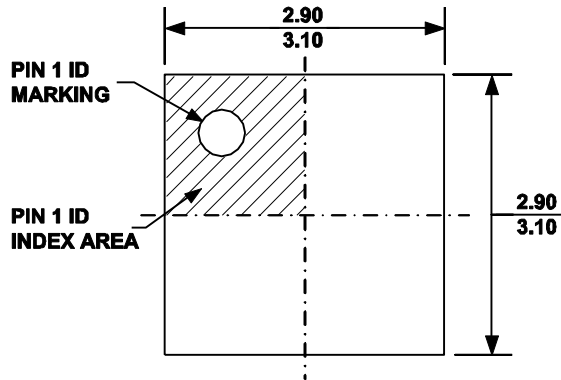

Figure 5—Flow Chart of Operation

PACKAGE INFORMATION

QFN10 (3mmx3mm)



TOP VIEW

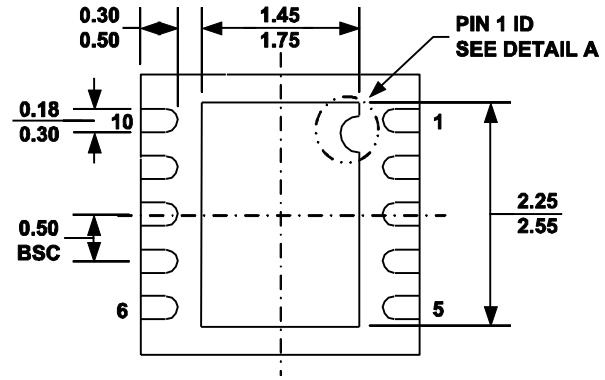

BOTTOM VIEW

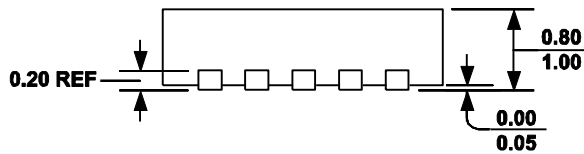

SIDE VIEW

PIN 1 ID OPTION A
R0.20 TYP.

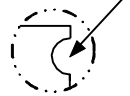

PIN 1 ID OPTION B
R0.20 TYP.

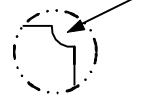

DETAIL A

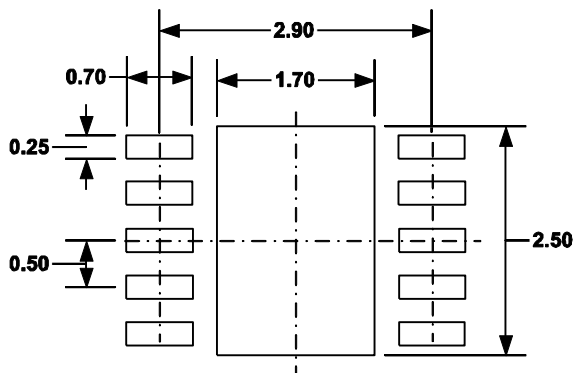

RECOMMENDED LAND PATTERN

NOTE:

- 1) ALL DIMENSIONS ARE IN MILLIMETERS.
- 2) EXPOSED PADDLE SIZE DOES NOT INCLUDE MOLD FLASH.
- 3) LEAD COPLANARITY SHALL BE 0.10 MILLIMETER MAX.
- 4) DRAWING CONFORMS TO JEDEC MO-229, VARIATION VEED-5.
- 5) DRAWING IS NOT TO SCALE.

REVISION HISTORY

Revision #	Revision Date	Description	Pages Updated
0.9	9/15/2008	Initial Release	-
1.0	5/18/2023	Updated the capacitor name from “CTHR” to “CTMR” in the Typical Application schematic; updated the package information sentence in the Description section	1
		Updated “uF” to “μF” and “uA” to “μA”	1, 3, 7, 9
		Updated the Battery Voltage Regulation parameter’s conditions from “I _{BATT} = 0” to “I _{BATT} = 100mA”	2
		Grammar and formatting updates	2–3
		Updated the Oscillation Freq parameter’s typical value from “5” to “5.4”	3
		Updated “us/div” to “μs/div” and “°C” to the correct symbol in the Typical Performance Curves section	6
		Updated “11Hz” to “11.9Hz” in the equation in the Timer Operation section	8
		Updated Figure 5 and the Package Information drawing with higher resolution images	10–11

NOTICE: The information in this document is subject to change without notice. Users should warrant and guarantee that third party Intellectual Property rights are not infringed upon when integrating MPS products into any application. MPS will not assume any legal responsibility for any said applications.