

Schottky Rectifier, Ultra-Low VF, 10 A, 45 V

FSV1045V

Description

The FSV1045V Schottky rectifier offers break-through size and performance. The device is optimized for mobile charger applications. It sinks only 18 mA reverse current at high temperature and provides forward voltage drop of 0.18 V at 1 A operating current in a charger design.

All this capability is packed into a small, flat-lead, TO-277 package, optimized for space-constrained applications. The FSV1045V supports a typical Z height of 1.1 mm. It is RoHS compliant and halogen free. It is also qualified for a wave soldering process.

Features

- Ultra-Low Forward Voltage Drop:
 - ◆ 0.41 V Typical at 10 A, $T_A = 25^\circ\text{C}$
 - ◆ 0.44 V Maximum at 10 A, $T_A = 25^\circ\text{C}$
- Low Thermal Resistance
- Very Low Profile: Typical Height of 1.1 mm
- Meets MSL 1 per JESD22-A111 Full-Body Solder Immersion
- Non-DAP Option Only
- This Device is Pb-Free, Halogen Free and is RoHS Compliant

Applications

- Mobile Charger
- Solar Panel
- Reverse Polarity Protection

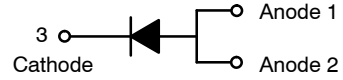

Schottky Rectifier

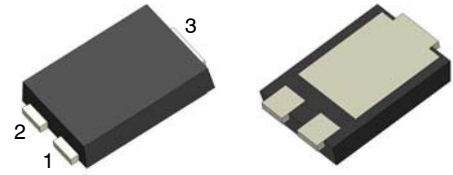

TO-277-3LD
CASE 340BQ

MARKING DIAGRAM

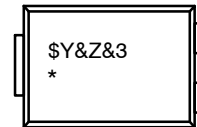

- | | |
|-----|-----------------------------------|
| \$Y | = onsemi Logo |
| &Z | = Assembly Plant Code |
| &3 | = Data Code (Year & Week) |
| * | = Specific Device Code
FSV1045 |

ORDERING INFORMATION

See detailed ordering and shipping information on page 3 of this data sheet.

ABSOLUTE MAXIMUM RATINGS (Note 1)

Symbol	Parameter		Value	Unit
V_{RRM}	Peak Repetitive Reverse Voltage		45	V
V_{RWM}	Working Peak Reverse Voltage		45	V
V_{RMS}	RMS Reverse Voltage		32	V
V_R	DC Blocking Voltage		45	V
I_O	Average Rectified Output Current (Note 2)	$T_L = 105^\circ\text{C}$	10	A
I_{FSM}	Non-Repetitive Peak Forward Surge Current (Note 3)		300	A
C_J	Typical Junction Capacitance	$V_R = 4\text{ V}, 1\text{ MHz}$	820	pF
T_J	Operating Junction Temperature Range		-55 to +150	$^\circ\text{C}$
T_{STG}	Storage Temperature Range		-55 to +150	$^\circ\text{C}$

Stresses exceeding those listed in the Maximum Ratings table may damage the device. If any of these limits are exceeded, device functionality should not be assumed, damage may occur and reliability may be affected.

1. All test conducted at $T_A = T_J = 25^\circ\text{C}$ unless otherwise noted
2. Mounted on 30 mm x 30 mm FR4 PCB
3. Pulse condition: 8.3 ms half-sine wave. Test method is compliant with MIL standard (MIL-STD-750E)

THERMAL CHARACTERISTICS ($T_A = 25^\circ\text{C}$ unless otherwise noted) (Note 4)

Symbol	Parameter	Minimum Land Pattern	Maximum Land Pattern	Unit
$R_{\theta JA}$	Junction-to-Ambient Thermal Resistance	100	40	$^\circ\text{C/W}$
Ψ_{JL}	Junction-to-Lead Thermal Characteristics, Thermocouple Soldered to Anode	15	12	$^\circ\text{C/W}$
	Junction-to-Lead Thermal Characteristics, Thermocouple Soldered to Cathode	6	5	

4. The thermal resistances ($R_{\theta JA}$ & Ψ_{JL}) are characterized with device mounted on the following FR4 printed circuit boards, as shown in Figure 1 and Figure 2. PCB size: 76.2 x 114.3 mm. Minimum land pattern size: 4.9 x 4.8 mm (big pattern, x1), 1.4 x 1.52 mm (small pattern, x2). Maximum land pattern size: 30 x 30 mm (pattern, x2). Force line trace size = 55 mils, sense line trace size = 4 mils.



Figure 1. Minimum Land Pattern of 2 oz Copper

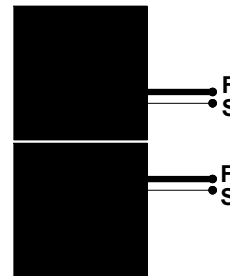

Figure 2. Maximum Land Pattern of 2 oz Copper

FSV1045V

ELECTRICAL CHARACTERISTICS ($T_A = 25^\circ\text{C}$ unless otherwise noted)

Symbol	Parameter	Conditions	Min	Typ	Max	Unit
V_{BR}	Breakdown Voltage	$I_T = 500 \mu\text{A}$	45			V
V_F	Forward Voltage Drop	$I_F = 1 \text{ A}$		0.28	0.44	V
		$I_F = 10 \text{ A}$				
		$I_F = 1 \text{ A}$	$T_A = 125^\circ\text{C}$	0.18	0.39	
		$I_F = 10 \text{ A}$				
I_R	Maximum Leakage	$V = V_{RWM}$	$T_A = 25^\circ\text{C}$	0.065	0.220	mA
			$T_A = 125^\circ\text{C}$	19	32	

Product parametric performance is indicated in the Electrical Characteristics for the listed test conditions, unless otherwise noted. Product performance may not be indicated by the Electrical Characteristics if operated under different conditions.

ORDERING INFORMATION

Part Number	Top Mark	Package	Shipping [†]
FSV1045V	FSV1045	TO-277-3LD (Pb-Free/Halogen Free)	5000 / Tape & Reel

[†]For information on tape and reel specifications, including part orientation and tape sizes, please refer to our Tape and Reel Packaging Specifications Brochure, BRD8011/D.

TYPICAL PERFORMANCE CHARACTERISTICS

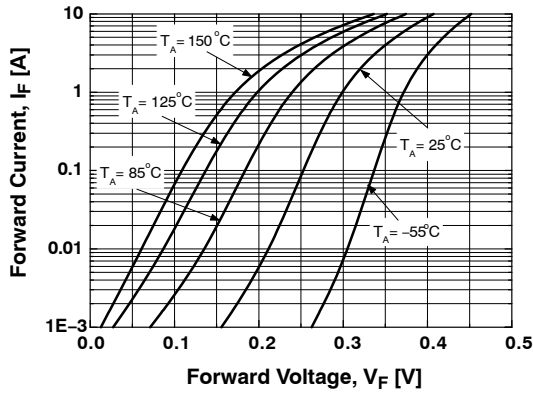

Figure 3. Forward Current Characteristics

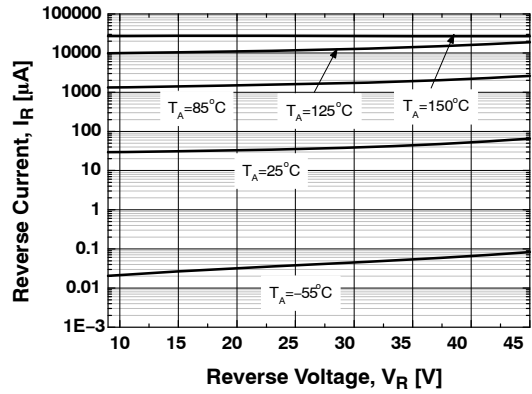

Figure 4. Typical Reverse Characteristics

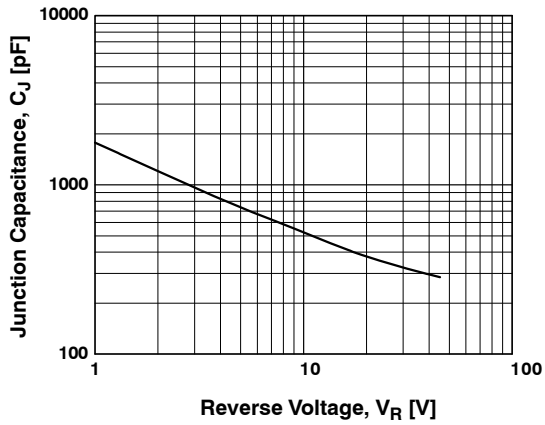

Figure 5. Typical Junction Capacitance

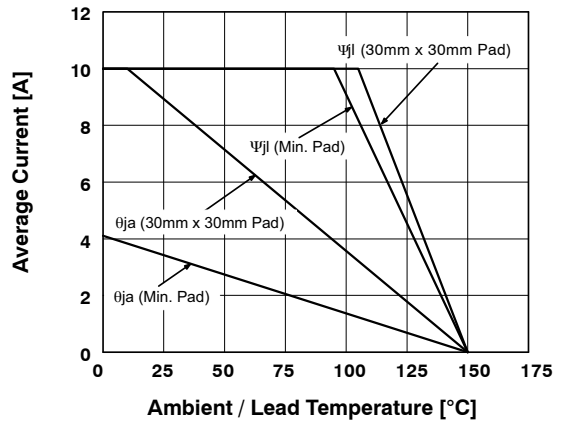

Figure 6. Forward Current Derating

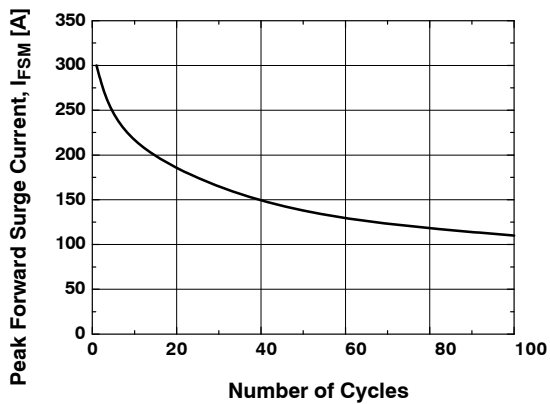
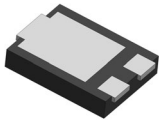

Figure 7. Surge Current Derating Curve



TO-277-3 5.91x4.44x1.10, 2.10P
CASE 340BQ
ISSUE A

DATE 16 APR 2026

NOTES:

1. DIMENSIONING AND TOLERANCING AS PER ASME Y14.5M, 2018.
2. CONTROLLING DIMENSION: MILLIMETERS.
3. DIMENSIONS D1 AND E1 DO NOT INCLUDE MOLD FLASH, MOLD FLASH SHALL NOT EXCEED 0.13 mm PER SIDE.

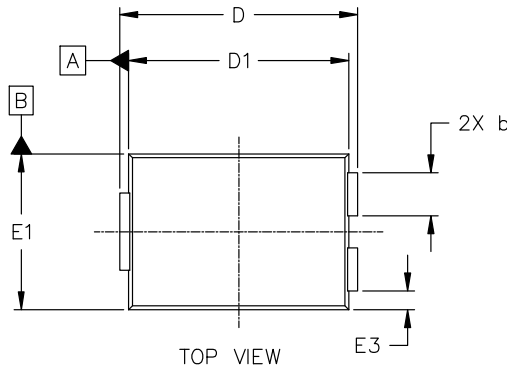

TOP VIEW

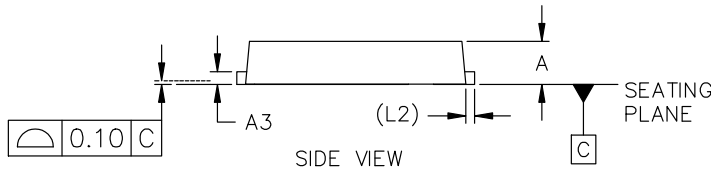

SIDE VIEW

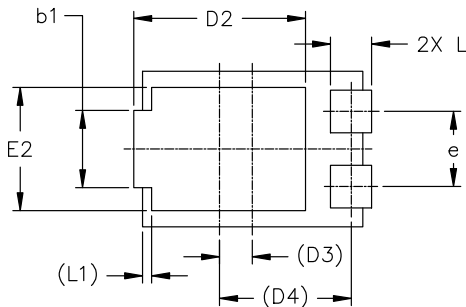

BOTTOM VIEW

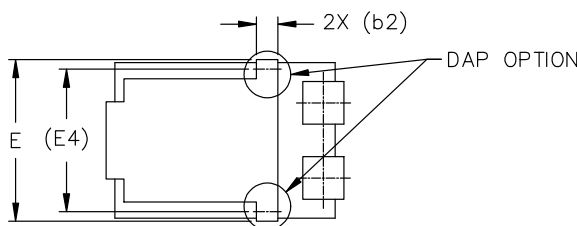

BOTTOM VIEW - DAP OPTION

MILLIMETERS			
DIM	MIN	NOM	MAX
A	1.00	1.10	1.20
A3	0.23	0.32	0.40
b	1.10	1.25	1.40
b1	1.95	2.10	2.25
b2	0.60 REF		
D	6.35	6.50	6.65
D1	5.67	5.91	6.15
D2	4.23	4.57	4.90
D3	0.913 REF		
D4	3.680 REF		
E	---	---	4.75
E1	4.25	4.44	4.63
E2	3.25	3.48	3.70
E3	0.43	0.53	0.63
E4	3.680 REF		
e	2.00	2.10	2.20
L	0.90	1.08	1.25
L1	0.25 REF		
L2	0.35 REF		

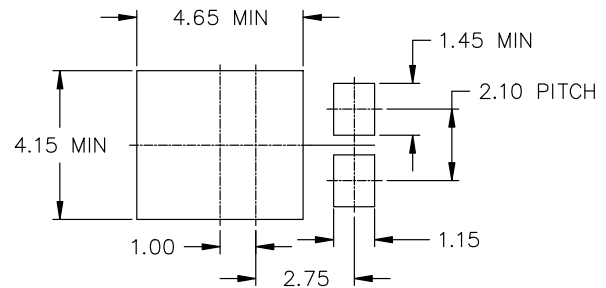

RECOMMENDED MOUNTING FOOTPRINT

*For additional information on our Pb-Free strategy and soldering details, please download the onsemi Soldering and Mounting Techniques Reference Manual, SOLDERRM/D.

DOCUMENT NUMBER:	98AON13861G	Electronic versions are uncontrolled except when accessed directly from the Document Repository. Printed versions are uncontrolled except when stamped "CONTROLLED COPY" in red.
DESCRIPTION:	TO-277-3 5.91x4.44x1.10, 2.10P	PAGE 1 OF 1

onsemi and Onsemi are trademarks of Semiconductor Components Industries, LLC dba onsemi or its subsidiaries in the United States and/or other countries. onsemi reserves the right to make changes without further notice to any products herein. onsemi makes no warranty, representation or guarantee regarding the suitability of its products for any particular purpose, nor does onsemi assume any liability arising out of the application or use of any product or circuit, and specifically disclaims any and all liability, including without limitation special, consequential or incidental damages. onsemi does not convey any license under its patent rights nor the rights of others.

onsemi, **Onsemi**, and other names, marks, and brands are registered and/or common law trademarks of Semiconductor Components Industries, LLC dba "**onsemi**" or its affiliates and/or subsidiaries in the United States and/or other countries. **onsemi** owns the rights to a number of patents, trademarks, copyrights, trade secrets, and other intellectual property. A listing of **onsemi**'s product/patent coverage may be accessed at www.onsemi.com/site/pdf/Patent-Marking.pdf. **onsemi** reserves the right to make changes at any time to any products or information herein, without notice. The information herein is provided "as-is" and **onsemi** makes no warranty, representation or guarantee regarding the accuracy of the information, product features, availability, functionality, or suitability of its products for any particular purpose, nor does **onsemi** assume any liability arising out of the application or use of any product or circuit, and specifically disclaims any and all liability, including without limitation special, consequential or incidental damages. Buyer is responsible for its products and applications using **onsemi** products, including compliance with all laws, regulations and safety requirements or standards, regardless of any support or applications information provided by **onsemi**. "Typical" parameters which may be provided in **onsemi** data sheets and/or specifications can and do vary in different applications and actual performance may vary over time. All operating parameters, including "Typicals" must be validated for each customer application by customer's technical experts. **onsemi** does not convey any license under any of its intellectual property rights nor the rights of others. **onsemi** products are not designed, intended, or authorized for use as a critical component in life support systems or any FDA Class 3 medical devices or medical devices with a same or similar classification in a foreign jurisdiction or any devices intended for implantation in the human body. Should Buyer purchase or use **onsemi** products for any such unintended or unauthorized application, Buyer shall indemnify and hold **onsemi** and its officers, employees, subsidiaries, affiliates, and distributors harmless against all claims, costs, damages, and expenses, and reasonable attorney fees arising out of, directly or indirectly, any claim of personal injury or death associated with such unintended or unauthorized use, even if such claim alleges that **onsemi** was negligent regarding the design or manufacture of the part. **onsemi** is an Equal Opportunity/Affirmative Action Employer. This literature is subject to all applicable copyright laws and is not for resale in any manner.

ADDITIONAL INFORMATION

TECHNICAL PUBLICATIONS:

Technical Library: www.onsemi.com/design/resources/technical-documentation
onsemi Website: www.onsemi.com

ONLINE SUPPORT: www.onsemi.com/support

For additional information, please contact your local Sales Representative at www.onsemi.com/support/sales

