

Features

- AEC-Q200 compliant & automotive grade
- ESD protection to IEC 61000-4-2 Level 4
- <1 ns response time to ESD strike
- Low leakage current
- Extremely low capacitance (0.2 pF typ.)
- Bidirectional device
- Multi-strike capability

Applications

- Camera links
- Sensors
- Touchscreen interfaces
- GPS
- Antennas
- USB 3.0
- High-speed communications buses

ChipGuard® MLC Series - ESD Protectors

General Information

Bourns® ChipGuard® Automotive MLC Series is a sub-1 pF protector designed specifically for use in circuits requiring ESD protection. The CGA-MLC series is available in industry standard 0402 and 0603 packages. In addition to its very low capacitance, these protectors exhibit extremely fast response times to ESD events making them ideal for protecting a wide array of high speed digital electronic applications.



The ChipGuard® MLC Series is fully AEC-Q200 compliant and supported.

Additional Information

Click these links for more information:



Electrical Characteristics @ 25 °C (unless otherwise noted)

Parameter	Symbol	CGA0402MLC-			CGA0603MLC-			Unit
		05G	12G	24G	05E	12E	24E	
DC Working Voltage	$V_W(DC)$	≤5	≤12	≤24	≤5	≤12	≤24	V
Maximum Leakage Current @ Max. $V_W(DC)$	I_L	<0.01						μA
Typical Clamping Voltage (Note 1)	V_C	30						V
Typical Trigger Voltage (Note 1)	V_T	300						V
Typical Peak Voltage (Note 2)	V_P	300						V
Typical Capacitance @ 1 MHz, 1 Vrms	C_O	0.2						pF
Response Time	R_T	<1						ns
ESD Protection: Per IEC 61000-4-2 Level 4 Min. Contact Discharge Min. Air Discharge Typical ESD Withstand		±8 ±15 (Note 3) 1000						kV kV Pulses
Operating Temperature	T_{OPR}	-55 to +125						°C
Storage Temperature	T_{STG}	-55 to +125						°C

Notes: 1. V_T and V_C measured using TLP (Transmission Line Pulse) method.
 2. Peak voltage measured under ESD Test Conditions: IEC61000-4-2, 8 kV contact discharge.
 3. IEC 61000-4-2 ESD Performance for CGA0603MLC-05E and CGA0603MLC-12E devices will meet minimum 100 reps. Some shifting in characteristics may occur when tested over several hundred ESD pulses. All other part numbers listed will meet IEC 61000-4-2 ESD Performance with minimum 1000 reps without degradation in performance.

BOURNS®

Asia-Pacific: Tel: +886-2 2562-4117 • Email: asiacus@bourns.com

Europe: Tel: +36 88 885 877 • Email: eurocus@bourns.com

Mexico: Tel: +52 614 478 0400 • Email: mexicus@bourns.com

The Americas: Tel: +1-951 781-5500 • Email: americus@bourns.com

www.bourns.com



WARNING Cancer and Reproductive Harm - www.P65Warnings.ca.gov

* RoHS Directive 2015/863, Mar 31, 2015 and Annex.

Specifications are subject to change without notice.

Users should verify actual device performance in their specific applications.

The products described herein and this document are subject to specific legal disclaimers as set forth on the last page of this document, and at www.bourns.com/docs/legal/disclaimer.pdf.

Product Dimensions

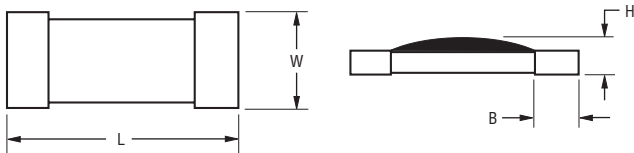

Dim.	CG0402MLC Series	CG0603MLC Series
L	$\frac{1.00 \pm 0.10}{(0.04 \pm 0.004)}$	$\frac{1.60 \pm 0.10}{(0.064 \pm 0.004)}$
W	$\frac{0.50 \pm 0.10}{(0.02 \pm 0.004)}$	$\frac{0.85 \pm 0.15}{(0.033 \pm 0.006)}$
H	$\frac{0.34 \pm 0.10}{(0.014 \pm 0.004)}$	$\frac{0.51 \pm 0.05}{(0.020 \pm 0.002)}$
B	$\frac{0.20 \pm 0.15}{(0.008 \pm 0.006)}$	$\frac{0.30 \pm 0.20}{(0.012 \pm 0.008)}$

Recommended Pad Layout

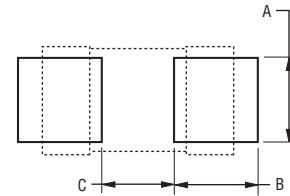

Dim.	CGA0402MLC Series	CGA0603MLC Series
A	$\frac{0.50 \pm 0.1}{(0.02 \pm 0.004)}$	$\frac{0.75 \pm 0.1}{(0.03 \pm 0.004)}$
B	$\frac{0.50 \pm 0.1}{(0.02 \pm 0.004)}$	$\frac{0.75 \pm 0.1}{(0.03 \pm 0.004)}$
C	$\frac{0.50 \pm 0.1}{(0.02 \pm 0.004)}$	$\frac{0.75 \pm 0.1}{(0.03 \pm 0.004)}$

DIMENSIONS: $\frac{\text{MM}}{\text{(INCHES)}}$

Solder Reflow Recommendations

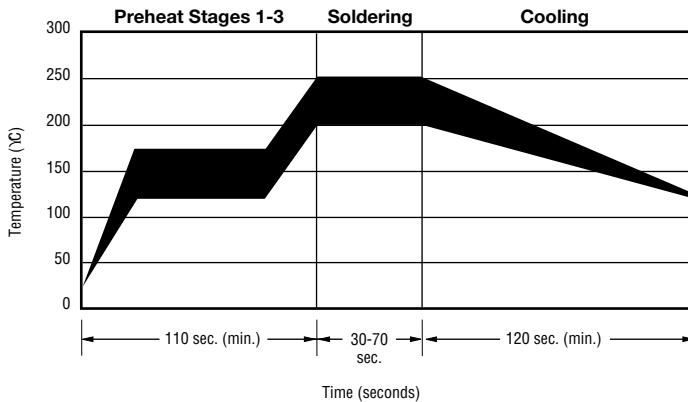

A	Stage 1 Preheat	Ambient to Preheating Temperature	30 s to 60 s
B	Stage 2 Preheat	140 °C to 160 °C	60 s to 120 s
C	Stage 3 Preheat	Preheat to 200 °C	20 s to 40 s
D	Main Heating	200 °C	60 s to 70s
		210 °C	55 s to 65 s
		220 °C	50 s to 60 s
		230 °C	40 s to 50 s
		240 °C	30 s to 40 s
E	Cooling	250 °C to 255 °C	5 s
		200 °C to 100 °C	1 °C/s to 4 °C/s

- This product can be damaged by rapid heating, cooling or localized heating.
- Heat shocks should be avoided. Preheating and gradual cooling recommended.
- Excessive solder can damage the device. Print solder thickness of 150 to 200 um recommended.
- Solder gun tip temperature should be kept below 280 °C and should not touch the device directly. Contact should be less than 3 seconds. A solder gun under 30 watts is recommended.

Specifications are subject to change without notice.

Users should verify actual device performance in their specific applications.

The products described herein and this document are subject to specific legal disclaimers as set forth on the last page of this document, and at www.bourns.com/docs/legal/disclaimer.pdf.

Packaging Dimensions

CGA0402MLC

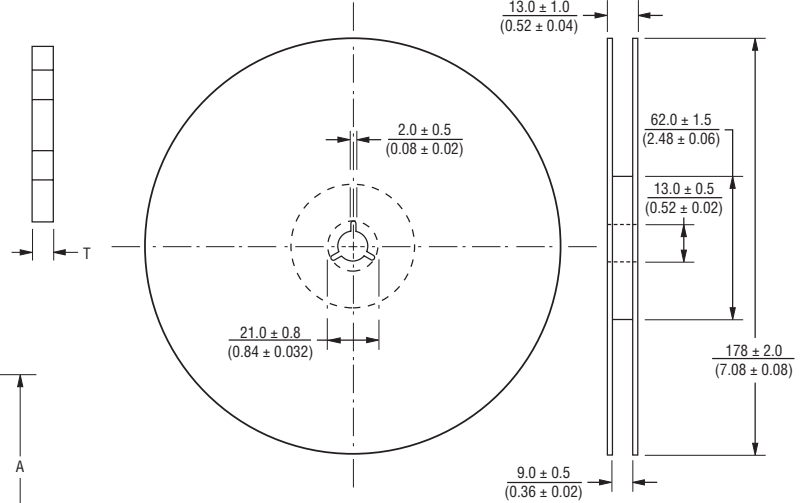
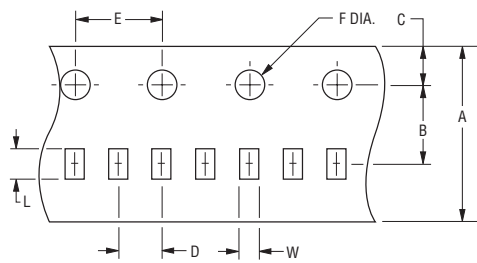

CGA0603MLC

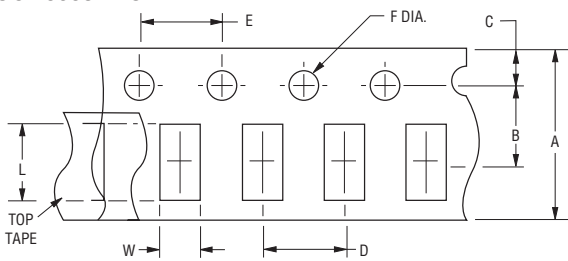

DIMENSIONS: $\frac{\text{MM}}{\text{(INCHES)}}$

Dimension	CGA0402MLC Series	CGA0603MLC Series
A	$\frac{8.00 \pm 0.30}{(0.315 \pm 0.012)}$	$\frac{8.00 \pm 0.30}{(0.315 \pm 0.012)}$
B	$\frac{3.50 \pm 0.05}{(0.138 \pm 0.002)}$	$\frac{3.50 \pm 0.05}{(0.138 \pm 0.002)}$
C	$\frac{1.75 \pm 0.10}{(0.069 \pm 0.004)}$	$\frac{1.75 \pm 0.10}{(0.069 \pm 0.004)}$
D	$\frac{2.00 \pm 0.05}{(0.079 \pm 0.002)}$	$\frac{4.00 \pm 0.05}{(0.157 \pm 0.002)}$
E	$\frac{4.00 \pm 0.10}{(0.157 \pm 0.004)}$	$\frac{4.00 \pm 0.10}{(0.157 \pm 0.004)}$
F	$\frac{1.50 \pm 0.10}{(0.059 \pm 0.004)}$	$\frac{1.50 \pm 0.10}{(0.059 \pm 0.004)}$
L	$\frac{1.13 \pm 0.03}{(0.044 \pm 0.001)}$	$\frac{1.90 \pm 0.20}{(0.075 \pm 0.008)}$
W	$\frac{0.63 \pm 0.03}{(0.025 \pm 0.001)}$	$\frac{1.05 \pm 0.20}{(0.041 \pm 0.008)}$
T	$\frac{0.43 \pm 0.03}{(0.017 \pm 0.001)}$	$\frac{0.60 \pm 0.03}{(0.024 \pm 0.0012)}$

How to Order

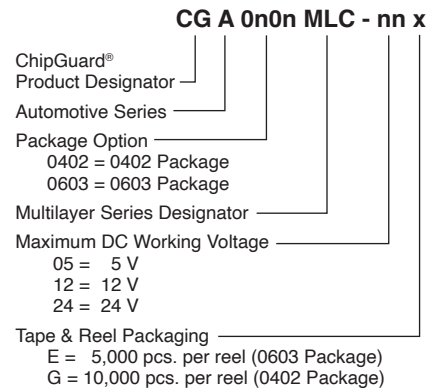

REV. F 09/24

Specifications are subject to change without notice.

Users should verify actual device performance in their specific applications.

The products described herein and this document are subject to specific legal disclaimers as set forth on the last page of this document, and at www.bourns.com/docs/legal/disclaimer.pdf.

This legal disclaimer applies to purchasers and users of Bourns® products manufactured by or on behalf of Bourns, Inc. and its affiliates (collectively, "Bourns").

Unless otherwise expressly indicated in writing, Bourns® products and data sheets relating thereto are subject to change without notice. Users should check for and obtain the latest relevant information and verify that such information is current and complete before placing orders for Bourns® products.

The characteristics and parameters of a Bourns® product set forth in its data sheet are based on laboratory conditions, and statements regarding the suitability of products for certain "typical" applications are based on Bourns' knowledge of typical requirements in generic applications. Bourns assumes that "typical" applications include failsafe/backup features to address critical risks to users and are designed to allow rework of Bourns® product to avoid scrap of a device solely due to malfunctioning Bourns® product. The characteristics and parameters of a Bourns® product in a user application may vary from the data sheet characteristics and parameters due to (i) the combination of the Bourns® product with other components in the user's application, or (ii) the environment of the user application itself. The characteristics and parameters of a Bourns® product also can and do vary in different applications and actual performance may vary over time. Thus, users should always verify the actual performance of the Bourns® product in their specific devices and applications and make their own independent judgments regarding the suitability of Bourns® product and the amount of additional test margin to design into their device or application to compensate for differences between laboratory and real-world conditions.

Unless Bourns has explicitly designated an individual Bourns® product as meeting the requirements of a particular industry standard (e.g., IATF 16949) or a particular qualification (e.g., UL listed or recognized), Bourns is not responsible for any failure of an individual Bourns® product to meet the requirements of such industry standard or particular qualification even if such industry standard or qualification is a "state of art". Users of Bourns® products are responsible for ensuring compliance with safety-related requirements and standards applicable to their devices or applications.

Bourns® products are not recommended, authorized or intended for use in applications where failure or malfunction may result in personal injury, death, or severe property or environmental damage, such as without limitation nuclear, life-critical medical and certain automotive and aviation applications. Except as set forth in the bullet points below or unless expressly and specifically approved in writing on a case-by-case basis by an authorized Bourns' representative, use of any Bourns® products in such unauthorized high-risk applications is at the user's sole risk.

- Bourns considers implantable/invasive devices and devices/procedures designed as life-supporting or life-sustaining by the U.S. Food and Drug Administration or equivalent organizations outside of the United States as "life-critical" medical applications. Bourns expressly identifies those Bourns® standard products that are suitable for use in typical medical applications that are not life-critical in its publication entitled "Bourns Medical Grade Component Guide."
- Bourns expressly identifies those Bourns® standard products that are suitable for use in typical automotive applications associated with any Automate Safety Integrity Level (ASIL) in its publication entitled "Bourns Automotive Grade Component Guide." Bourns' designation of Bourns® product as compliant with the AEC-Q standard does not by itself mean that Bourns has approved such product for use in an automotive application.
- Bourns expressly identifies Bourns® standard products that are suitable for use in the typical aviation applications/systems requiring System Design Assurance Level (RTCA DO-254 DAL) of C, D or E in its publication entitled "Bourns Civilian Aerospace/Aviation Grade Component Guide." Bourns does not test its products for compliance with United States Federal Aviation Administration standards or any other generally equivalent governmental organization standard applicable to products designed or manufactured for use in aviation applications. Use of Bourns® standard components in aviation applications associated with RTCA DO-254 DAL A or B without proper approval noted above shall be at the user's sole risk.
- Bourns will review and authorize on a case-by-case basis the use of Bourns® standard products which are at least AEC-Q compliant in space-related civil applications (rockets, satellites) with a negotiated cross-waiver and indemnity agreement.

The use and level of testing applicable to Bourns® custom products shall be negotiated on a case-by-case basis by Bourns and the user for which such Bourns® custom products are specially designed. Absent a written agreement between Bourns and the user regarding the use and level of such testing, the above provisions applicable to Bourns® standard products shall also apply to such Bourns® custom products.

Use of Bourns® products or Bourns' technology in military/defense applications must be reviewed with Bourns for compliance with applicable export control laws and embargoes. Users shall not sell, transfer, export or re-export (which includes transfers within a country) any Bourns® products or technology or technical data for use in activities which involve the design, development, production, use or stockpiling of nuclear, chemical or biological weapons or missiles, nor shall they use Bourns® products or technology or technical data in any facility which engages in activities relating to such devices. Further, Bourns® products and Bourns' technology and technical data may not under any circumstance be exported or re-exported to countries subject to international sanctions or embargoes. Bourns® products and technology may not, without prior authorization from Bourns and/or the Government of a country where such product/technology is designed and/or manufactured, be resold, transferred, or re-exported (including within the same country) to any party not eligible to receive commodities, software, and technical data originating in such country.

To the maximum extent permitted by applicable law, Bourns disclaims (i) any and all liability for special, punitive, consequential, incidental or indirect damages or lost revenues or lost profits, and (ii) any and all implied warranties (those not based on parameters specified in Bourns' data sheets and/or specifications), including implied warranties of fitness for particular purpose, non-infringement and merchantability.

For your convenience, copies of this Legal Disclaimer Notice with German, Spanish, Japanese, Traditional Chinese and Simplified Chinese bilingual versions are available at:

Web Page: <https://www.bourns.com/legal/disclaimers-terms-and-policies>

PDF: <https://www.bourns.com/docs/Legal/disclaimer.pdf>