

BT111 Development Kit

DATA SHEET

Wednesday, 15 May 2013

Version 1.1



VERSION HISTORY

Version	Comment
1.0	Public version
1.1	Updated contact details

Not Recommended for New Designs

TABLE OF CONTENTS

1	Design Overview	5
2	Using DKBT111 for the First Time	7
2.1	Configuring PS keys over SPI.....	8
2.2	Configuring PS keys over USB	9
3	Schematic and Layout of DKBT111	11
4	Contact Information	14

Not Recommended for New Designs

1 Design Overview

BT111 development kit is targeted for engineers evaluating BT111 *Bluetooth Smart Ready HCI module* and developing or prototyping *Bluetooth Smart Ready* systems utilizing BT111 module. BT111 Development Kit features:

- BT111 development board including
 - USB connector
 - Header for direct current consumption measurements
 - Reset button
 - Power on LED
 - Header for SPI interface for setting the parameters through SPI
 - All I/Os and supply voltages exposed with 2.54 mm pitch for connecting the kit on prototyping board using a pin header
- Bluegiga on-board installation kit (SPI cable)
- Ribbon cable and an adapter PCB for connecting the SPI with Bluegiga on-board installation kit
- BT111-A sample module



Figure 1: DKBT111, SPI adapter and programming cable

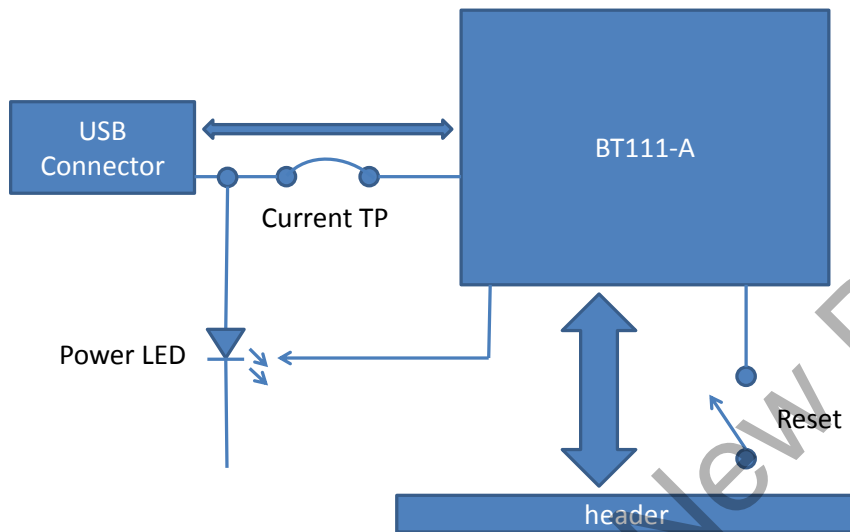

Figure 2: DKBT111 Block Diagram

Please refer to the latest datasheet of BT111 for information about the BT111 module. The physical outlook of the development board is shown in Figure 3 below.

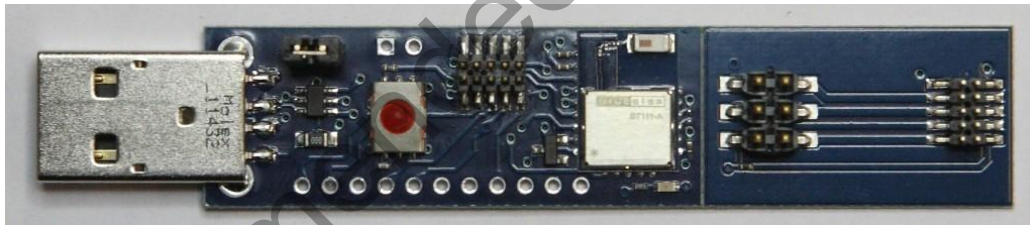

Figure 3: DKBT111

2 Using DKBT111 for the First Time

As shown in the Figure 3 in previous chapter, the SPI adapter board is attached to the development board. When you start using DKBT111, it is important to first break the adapter off from the development kit. This assures proper operation of the chip antenna. Figure 4 shows the development kit with SPI adapter removed and attached to the on-board installation kit.

The configuration and test tool suite BlueSuite can be downloaded at the Bluegiga Tech Forum. Please restart your computer after installing BlueSuite like the installer requests. The SPI transport may not work otherwise.



Figure 4: On-board installation kit connected to DKBT111

2.1 Configuring PS keys over SPI

1. Connect DKBT111 to the USB port of a PC
2. Make sure the power LED turns on
3. Connect the SPI programming cable to the PC and to the SPI interface on the DKBT111
4. Open **PSTool** application and select SPI as the transport as shown in the figure below

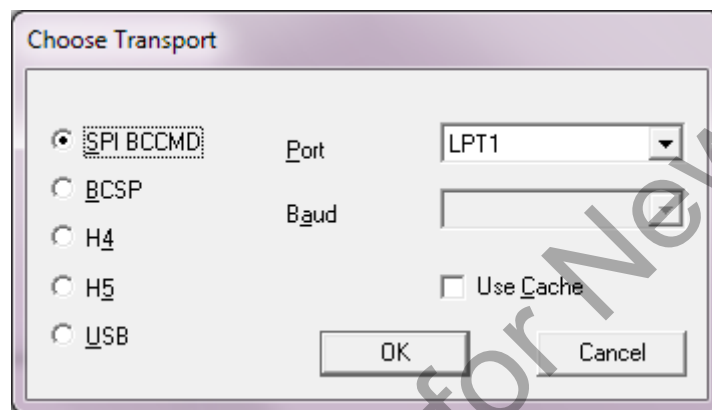

Figure 5: Choosing transport

You can now modify the PS-keys that are stored on BT111's EEPROM.

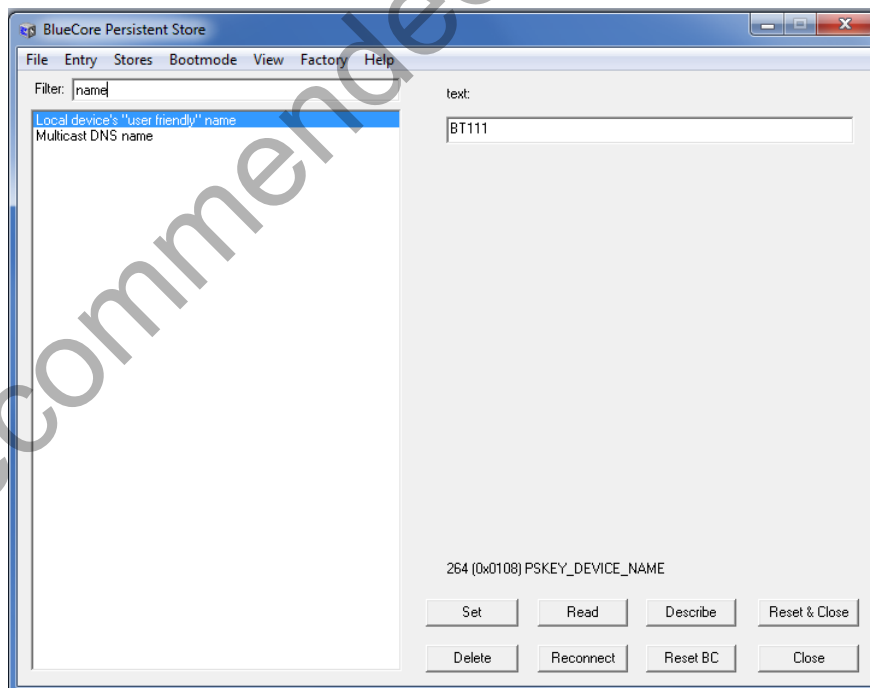

Figure 6: Changing the device friendly name

Note:

Do not modify the PS-keys unless you are absolutely sure what the change will do or unless you are advised to change a PS-key by Bluegiga.

2.2 Configuring PS keys over USB

Because BT111 is recognized as a generic *Bluetooth* radio by the operating system, the OS will load its own *Bluetooth* stack drivers for the BT111. In order to modify the PS-keys via USB interface a special USB driver needs to be installed.

In order to install the USB driver, please do the following steps:

1. Download the BT111 USB driver from Tech Forum
2. Start **Device Manager** from Windows **Control Panel**
3. Right-click on the **Generic Bluetooth Adapter**, then select **Update Driver Software...**
4. Choose **Browse my computer for driver software**.

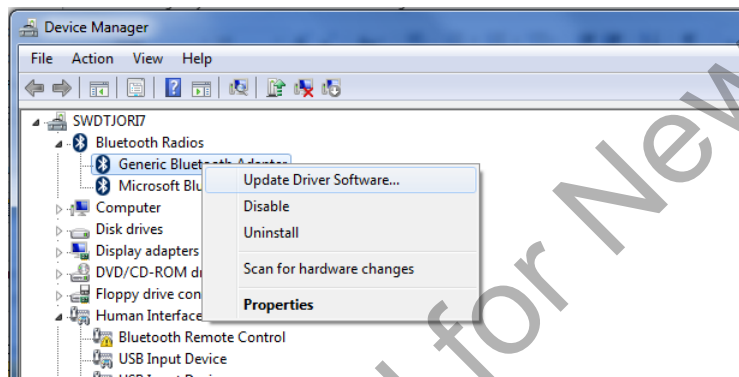

Figure 7: Update driver software

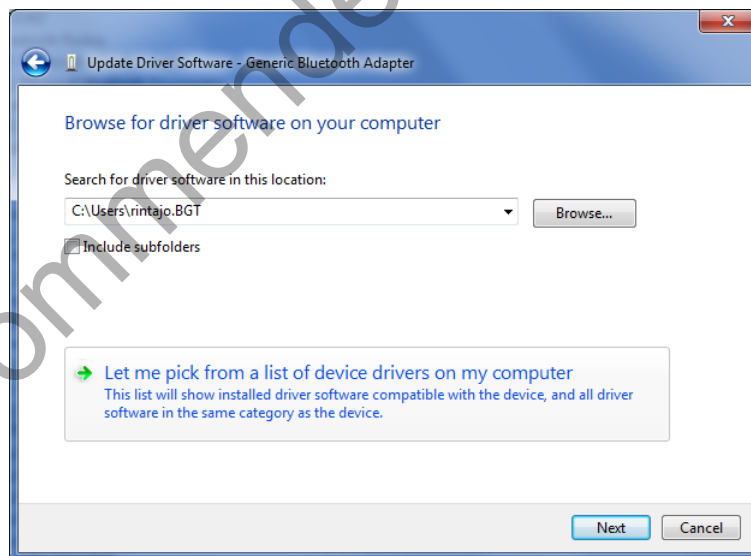

Figure 8. Browse for driver software

1. Click on **Let me pick from a list of device drivers on my computer**, then click **Have Disk...**
2. Select the location where you saved the BT111 USB drivers

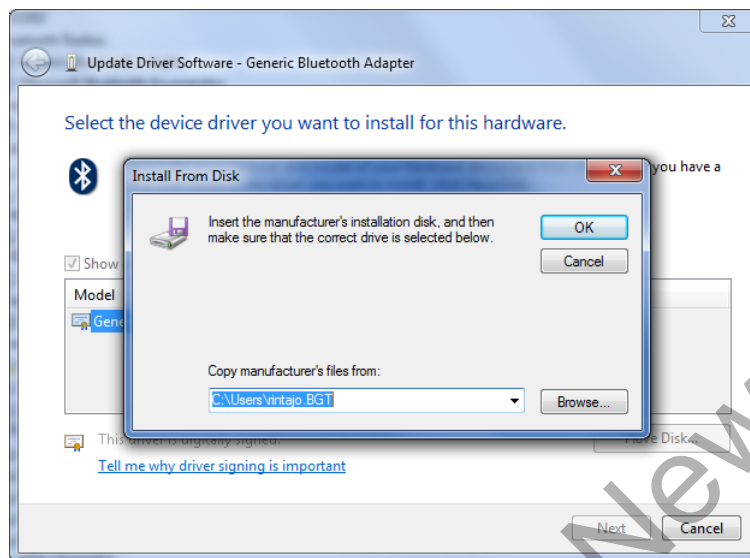

Figure 9: Install from disk

1. Windows will warn that the driver is not digitally signed; choose to install anyway.

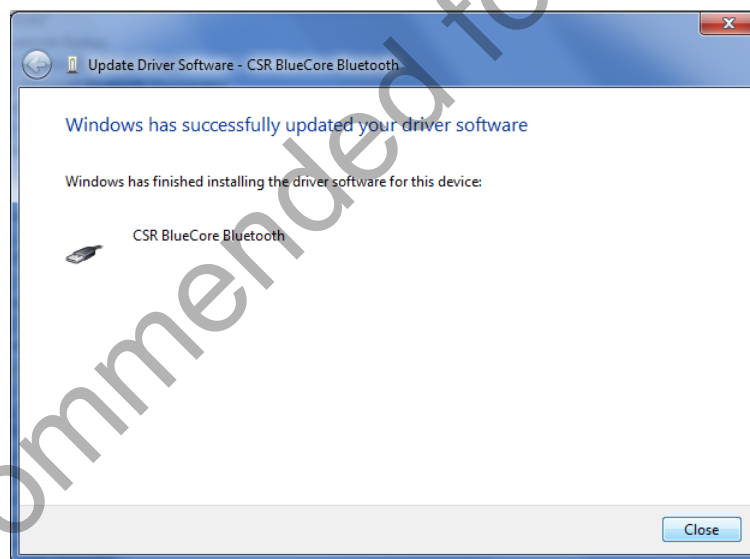

Figure 10. Installation successful

When the installation completes, BT111 will re-enumerate as a “**CSR BlueCore Bluetooth**”, and can now be accessed with **PSTool** software. In PSTool Select USB as the transport, the port field will be automatically filled with “\\.\csr0”.

When you wish to return to normal operation, you can repeat the procedure to select a driver from a list, but this time select the Microsoft Generic *Bluetooth* Adapter driver.

3 Schematic and Layout of DKBT111

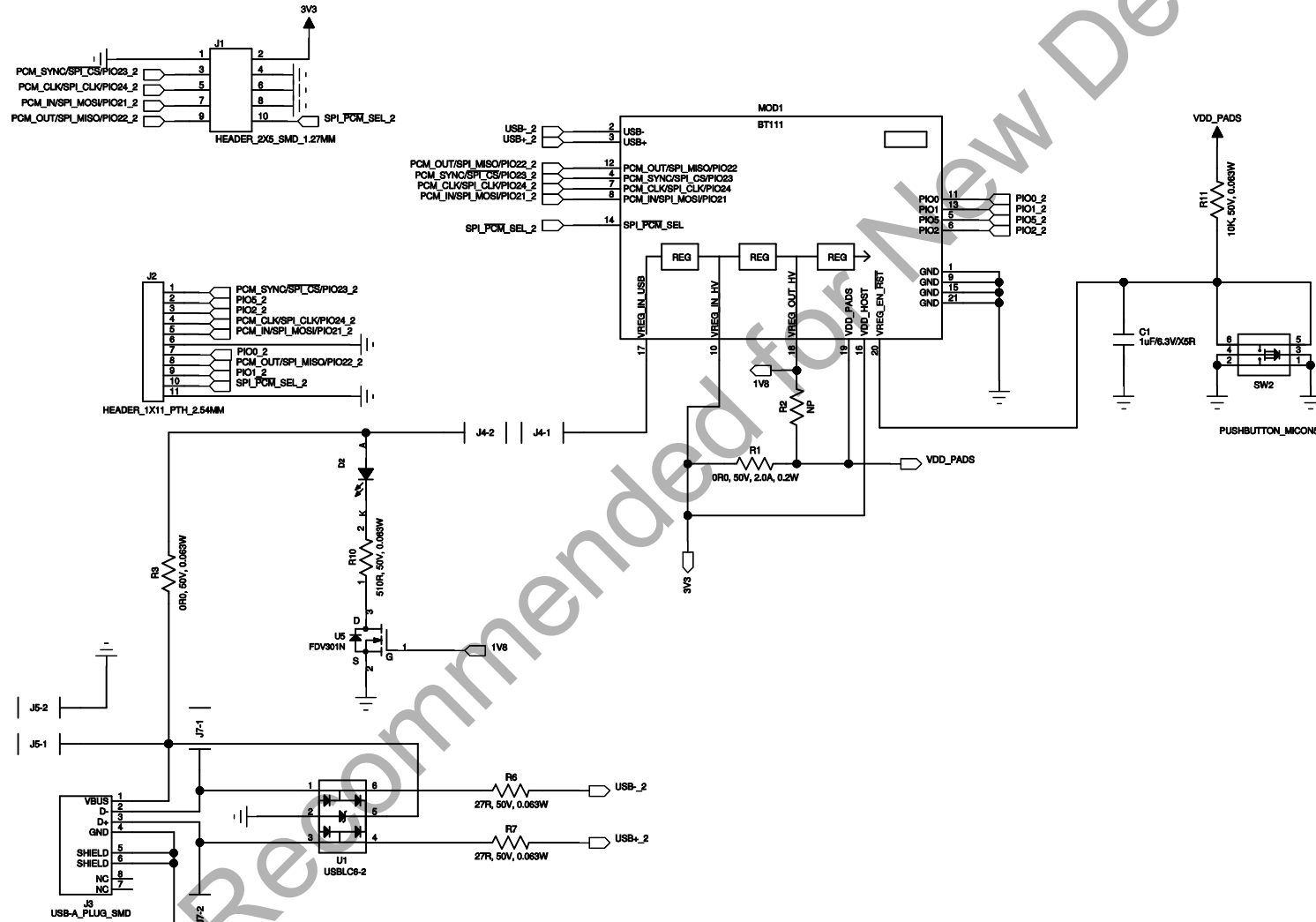

Figure 11: DKBT111 Schematic

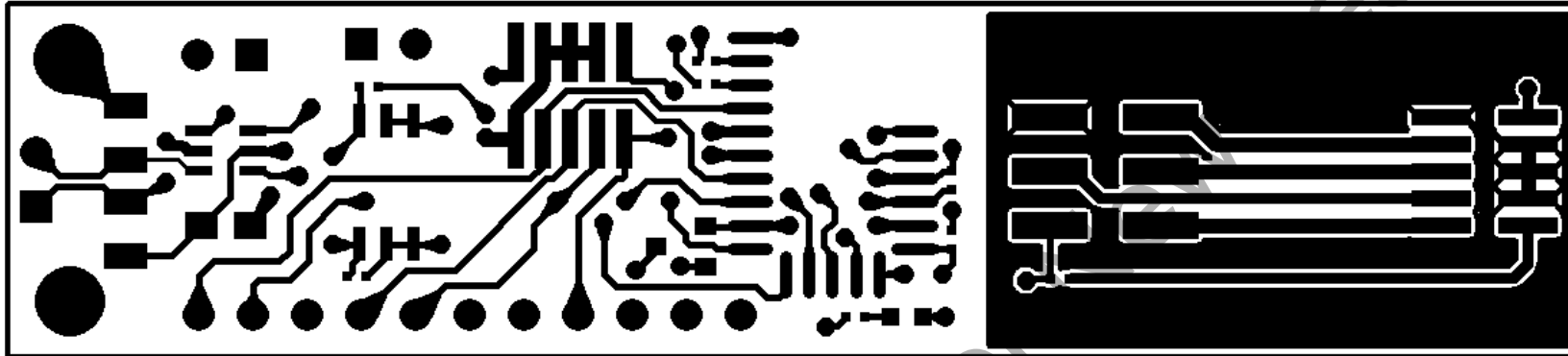

Figure 12: Top layer layout

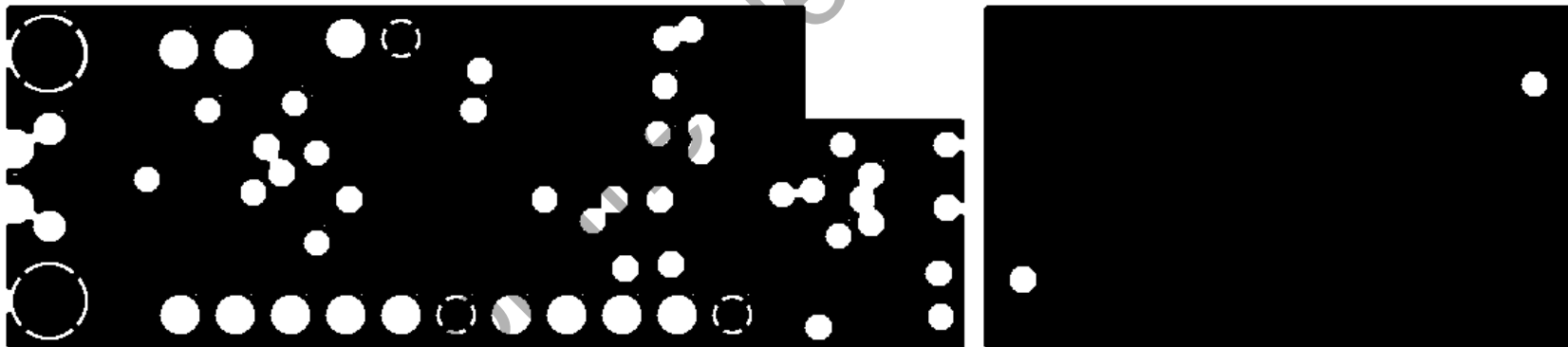

Figure 13: 2nd layer layout

Not Recommended for designs

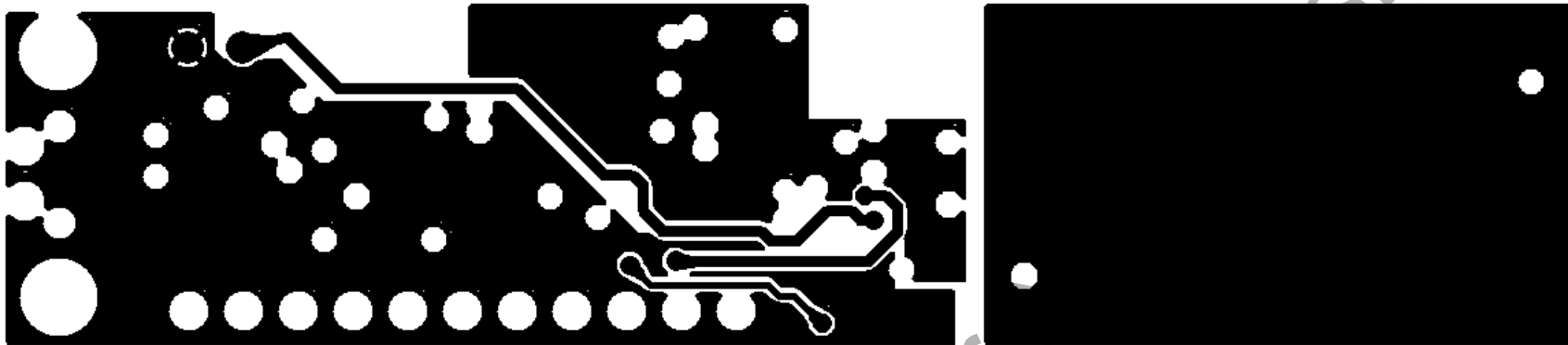

Figure 14: 3rd layer layout

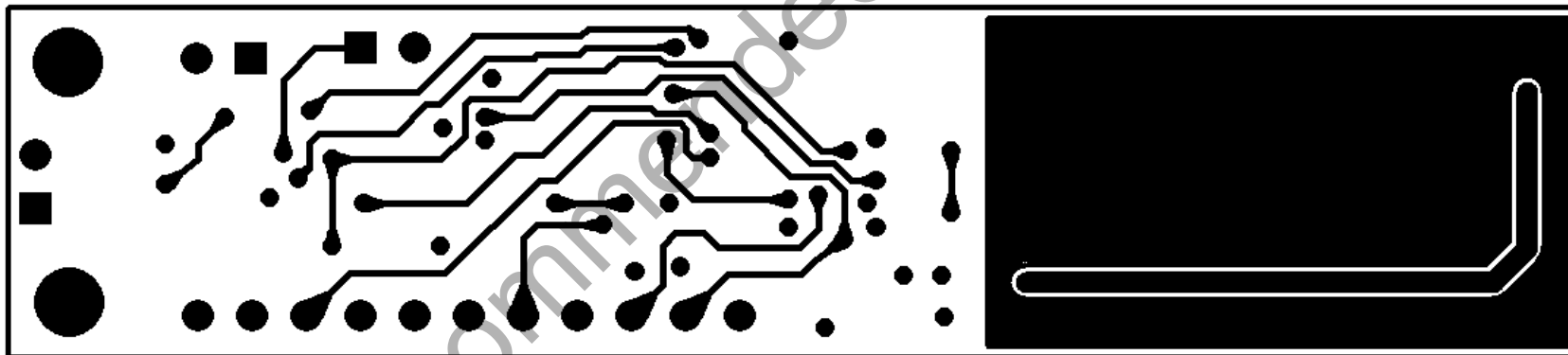
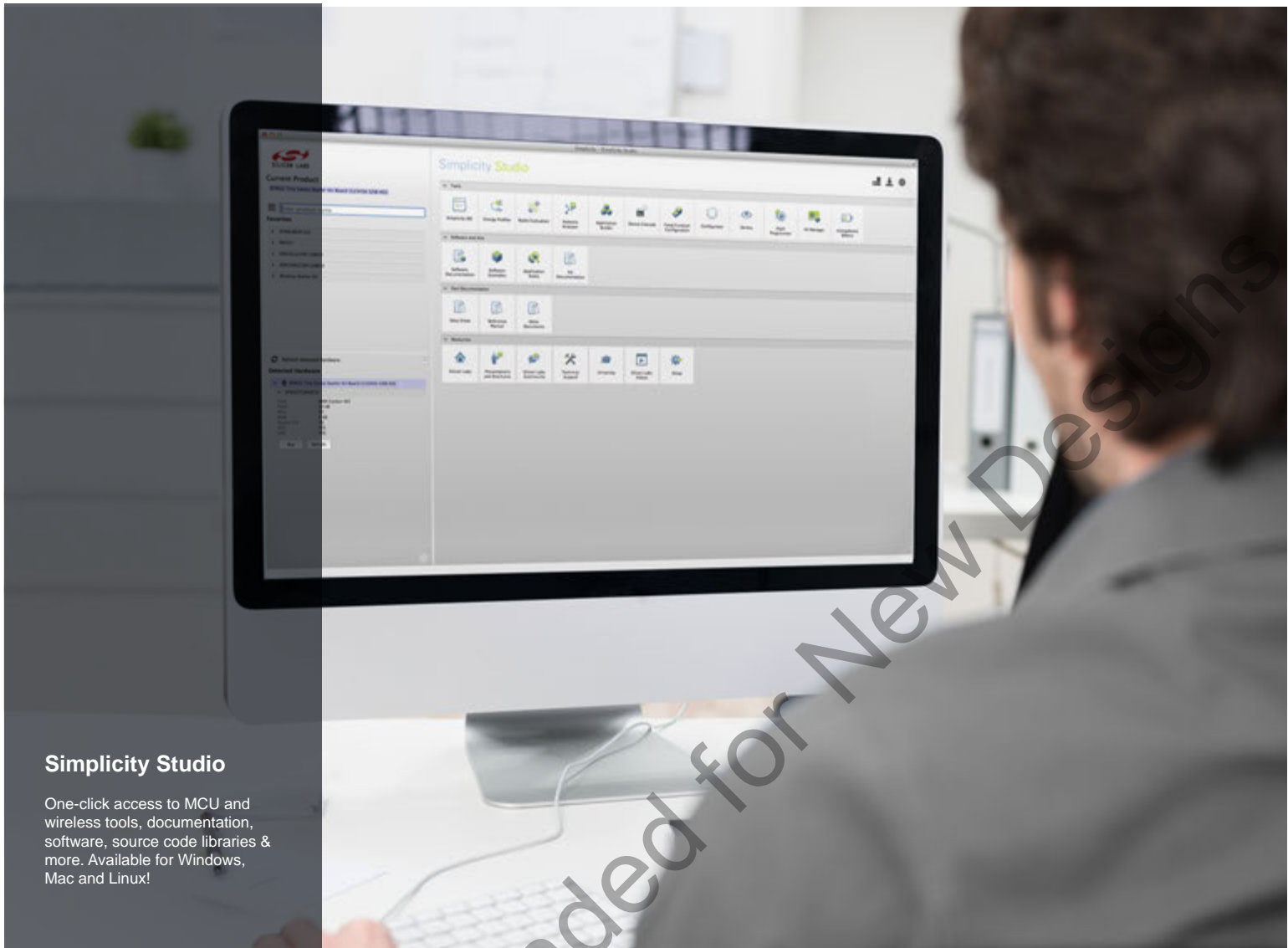

Figure 15: Bottom layer layout

Not Recommended for Signs



Simplicity Studio

One-click access to MCU and wireless tools, documentation, software, source code libraries & more. Available for Windows, Mac and Linux!



IoT Portfolio
www.silabs.com/IoT



SW/HW
www.silabs.com/simplicity



Quality
www.silabs.com/quality



Support and Community
community.silabs.com

Disclaimer

Silicon Laboratories intends to provide customers with the latest, accurate, and in-depth documentation of all peripherals and modules available for system and software implementers using or intending to use the Silicon Laboratories products. Characterization data, available modules and peripherals, memory sizes and memory addresses refer to each specific device, and "Typical" parameters provided can and do vary in different applications. Application examples described herein are for illustrative purposes only. Silicon Laboratories reserves the right to make changes without further notice and limitation to product information, specifications, and descriptions herein, and does not give warranties as to the accuracy or completeness of the included information. Silicon Laboratories shall have no liability for the consequences of use of the information supplied herein. This document does not imply or express copyright licenses granted hereunder to design or fabricate any integrated circuits. The products are not designed or authorized to be used within any Life Support System without the specific written consent of Silicon Laboratories. A "Life Support System" is any product or system intended to support or sustain life and/or health, which, if it fails, can be reasonably expected to result in significant personal injury or death. Silicon Laboratories products are not designed or authorized for military applications. Silicon Laboratories products shall under no circumstances be used in weapons of mass destruction including (but not limited to) nuclear, biological or chemical weapons, or missiles capable of delivering such weapons.

Trademark Information

Silicon Laboratories Inc.®, Silicon Laboratories®, Silicon Labs®, SiLabs® and the Silicon Labs logo®, Bluegiga®, Bluegiga Logo®, Clockbuilder®, CMEMS®, DSPLL®, EFM®, EFM32®, EFR®, Ember®, Energy Micro, Energy Micro logo and combinations thereof, "the world's most energy friendly microcontrollers", Ember®, EZLink®, EZRadio®, EZRadioPRO®, Gecko®, ISoModem®, Precision32®, ProSLIC®, Simplicity Studio®, SIPHY®, Telegesis, the Telegesis Logo®, USBXpress® and others are trademarks or registered trademarks of Silicon Laboratories Inc. ARM, CORTEX, Cortex-M3 and THUMB are trademarks or registered trademarks of ARM Holdings. Keil is a registered trademark of ARM Limited. All other products or brand names mentioned herein are trademarks of their respective holders.



Silicon Laboratories Inc.
 400 West Cesar Chavez
 Austin, TX 78701
 USA

<http://www.silabs.com>