

TRS 5VDC 2CO EMPTY

Weidmüller Interface GmbH & Co. KG
 Klingenbergstraße 26
 D-32758 Detmold
 Germany

www.weidmueller.com

Product image

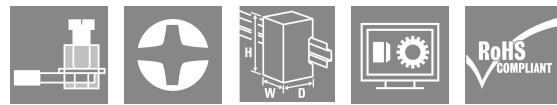
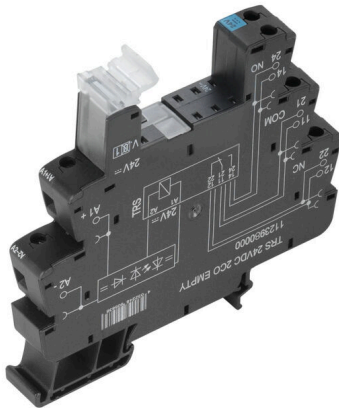

Similar to illustration

TERMSERIES empty sockets with:

- 2 CO contacts
- Unique multi-voltage input from 24 to 230 V UC
- Input voltages from 5 V DC to 230 V UC with coloured marking: AC: red, DC: blue, UC: white
- Due to high-quality design and no sharp edges no risk of injuries during installation
- Partition plates for optical separation and reinforcement of insulation

General ordering data

Version	TERMSERIES, Relay socket, Number of contacts: 2, CO contact, Rated control voltage: 5 V DC \pm 20 %, Continuous current: 10 A, Screw connection
Order No.	1123950000
Type	TRS 5VDC 2CO EMPTY
GTIN (EAN)	4032248906154
Qty.	10 items
Delivery status	This article will no longer be available in the future.
Available until	2026-11-30T00:00:00+01:00

Creation date 19.02.2026 09:19:20 MEZ

Catalogue status / Drawings

TRS 5VDC 2CO EMPTY

Weidmüller Interface GmbH & Co. KG

Klingenbergstraße 26

D-32758 Detmold

Germany

www.weidmueller.com

Technical data

Approvals

Approvals



ROHS Conform

UL File Number Search [UL Website](#)

Certificate No. (cURus) E223759

Dimensions and weights

Depth	87.8 mm	Depth (inches)	3.4567 inch
Height	89.6 mm	Height (inches)	3.5276 inch
Width	12.8 mm	Width (inches)	0.5039 inch
Net weight	42 g		

Temperatures

Storage temperature	-40 °C...85 °C	Ambient temperature	-40 °C...60 °C
Operating temperature			

Environmental Product Compliance

RoHS Compliance Status	Compliant with exemption
RoHS Exemption (if applicable/known)	7a, 7cl
REACH SVHC	Lead 7439-92-1
SCIP	9e2cbc49-76d9-4611-b8ec-5b4f549a0aa9

Rated data UL

Ambient temperature (operational), max.	60 °C	Output current derating (ohmic)	6 A @ 60 °C, 8 A @ 50 °C
Connection cross-section AWG, min.	AWG 26	Connection cross-section AWG, max.	AWG 14
Type of conductor	rigid copper conductor, flexible copper conductor	Tightening torque, max.	0.4 Nm
Pollution severity level	2	Certificate No. (cURus)	E223759

Control side

Rated control voltage	5 V DC \pm 20 %	Status indicator	Green LED
Protective circuit	Free-wheeling diode, Reverse polarity protection	Coil voltage of the replacement relay deviating from the rated control voltage	No
Coil voltage of the replacement relay	5 V DC		

Load side

Rated switching voltage	250 V AC	Continuous current	10 A
Contact type	2 CO contact		

General data

Operating altitude	\leq 2000 m, above sea level		
Mounting rail	TS 35		
Colour	black		
UL94 flammability rating component	Component	Housing	
	UL94 flammability rating	V-0	
	Component	Retaining clip	

Creation date 19.02.2026 09:19:20 MEZ

Catalogue status / Drawings

TRS 5VDC 2CO EMPTY

Weidmüller Interface GmbH & Co. KG

Klingenbergstraße 26

D-32758 Detmold

Germany

www.weidmueller.com

Technical data

| UL94 flammability rating

V-0

Insulation coordination

Rated voltage	300 V	Pollution severity	2
Surge voltage category	III	Clearance and creepage distances for control side - load side	≥ 5.5 mm
Dielectric strength for control side - load side	1.2 kVeff / 5 s	Dielectric strength of neighbouring contacts	2.5 kVeff
Dielectric strength to mounting rail	4 kVeff / 1 Min.	Impulse withstand voltage	6 kV (1.2/50 µs)
Protection degree	IP20		

Further details of approvals / standards

Certificate No. (cURus)	E223759
-------------------------	---------

Connection data

Wire connection method	Screw connection	Stripping length, rated connection	8 mm
Tightening torque, max.	0.4 Nm	Clamping range, rated connection	1.5 mm ²
Clamping range, min.	0.14 mm ²	Clamping range, max.	2.5 mm ²
Wire connection cross section AWG, min.	AWG 26	Wire connection cross section AWG, max.	AWG 14
Wire cross-section, solid, min.	0.14 mm ²	Wire cross-section, solid, max.	2.5 mm ²
Wire cross-section, solid, min. (AWG)	AWG 26	Wire cross-section, solid, max. (AWG)	AWG 14
Wire connection cross section, finely stranded, min.	0.14 mm ²	Wire connection cross section, finely stranded, max.	2.5 mm ²
Wire cross-section, finely stranded, min. (AWG)	AWG 26	Wire cross-section, finely stranded, max. (AWG)	AWG 14
Wire connection cross-section, finely stranded with wire-end ferrules DIN 46228/4, min.	0.25 mm ²	Wire connection cross-section, finely stranded with wire-end ferrules DIN 46228/4, max.	2.5 mm ²
Conductor cross-section, flexible, AEH (DIN 46228-1), min.	0.25 mm ²	Conductor cross-section, flexible, AEH (DIN 46228-1), max.	2.5 mm ²
Wire connection cross section, finely stranded, two clampable wires, min.	0.5 mm ²	Wire cross-section, finely stranded, two clampable wires, max.	1 mm ²
Twin wire-end ferrules, min.	0.5 mm ²	Twin wire-end ferrules, max.	1 mm ²
Blade size	size PHO	Pitch in mm (P)	5.00 mm

Classifications

ETIM 8.0	EC001456	ETIM 9.0	EC001456
ETIM 10.0	EC001456	ECLASS 14.0	27-37-16-03
ECLASS 15.0	27-37-16-03		

TRS 5VDC 2CO EMPTY

Weidmüller Interface GmbH & Co. KG
Klingenbergstraße 26
D-32758 Detmold
Germany

www.weidmueller.com

Drawings

Wiring diagram

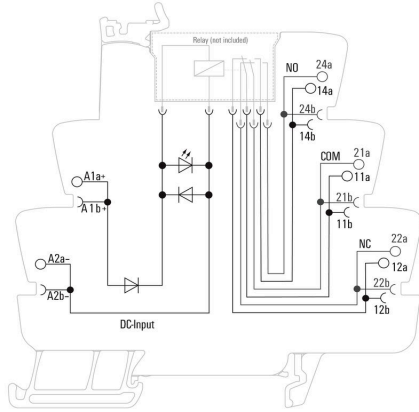

Dimensional drawing

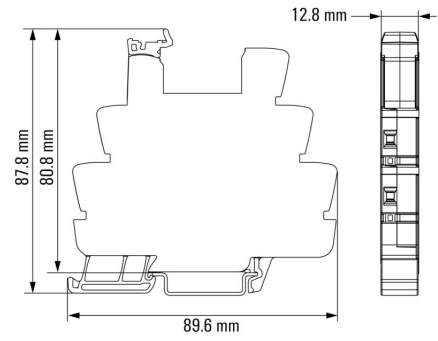

Miscellaneous

Type code TERMSERIES empty sockets

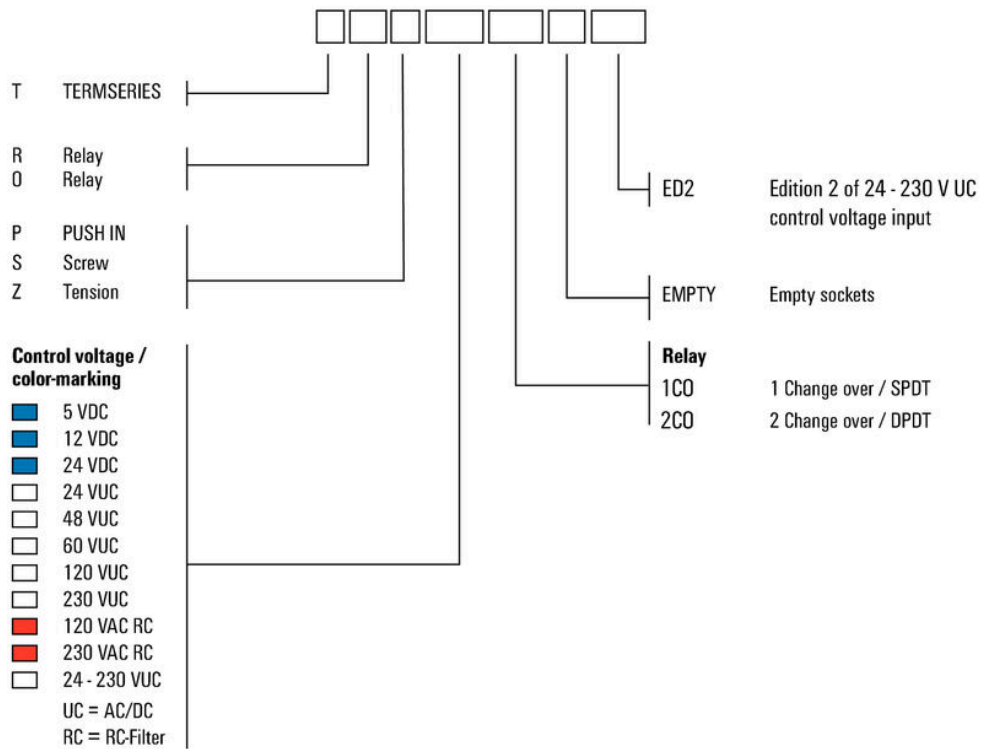

Type codes

TRS 5VDC 2CO EMPTY

Weidmüller Interface GmbH & Co. KG
Klingenbergstraße 26
D-32758 Detmold
Germany

www.weidmueller.com

Accessories

Partition plate



Versatile separation plates

Separation plates can be used to group together signals visually, to electrically isolate modules and to insert markings for a better overview. This makes them a particularly versatile accessory. Separation plates increase the clearance and creepage distances between two modules, thus increasing the rated insulation voltage between two modules to up to 600 V. Double separation plates can be marked with WAD5 or WS10/5 markers and enable continuous cross-connections. Installation is made easier with the perforations to individually break out the cross-connection channels.

- Partition plates visually separates groups from each other
- Indentations for individual breaking out the crossconnection channels
- Partition plates isolates between two modules by increasing the clearance and creepage distances of up to 600 V

General ordering data

Type	TW TXS/TXZ R3.2	Version	
Order No.	1240800000	TERMSERIES, Partition plate	
GTIN (EAN)	4050118028188		
Qty.	10 ST		

Supply module



Space-saving supply modules

Our supply terminals enable potentials to be fed at the input – e.g. neutral or minus potentials – or switched potentials to be fed at the output. In conjunction with precisely fitting cross-connections from the TERMSERIES, the connections for the cables on the relay module remain free for actuators or sensors. No additional feed-through terminal blocks are required, resulting in huge space savings in the panel. At the same time, the wiring is simplified as no double wire-end ferrules are required for the potential feed.

General ordering data

Type	TXP SUPPLY	Version	
Order No.	2618940000	TERMSERIES, Supply module, Number of contacts: 5, Continuous	
GTIN (EAN)	4050118667592	current: 10 A, PUSH IN	
Qty.	10 ST		

TRS 5VDC 2CO EMPTY

Weidmüller Interface GmbH & Co. KG

 Klingenbergstraße 26
 D-32758 Detmold
 Germany

www.weidmueller.com

Accessories

Type	TXS SUPPLY	Version
Order No.	1240780000	TERMSERIES, Supply module, Number of contacts: 5, , Continuous
GTIN (EAN)	4050118028140	current: 10 A, Screw connection
Qty.	10 ST	
Type	TXZ SUPPLY	Version
Order No.	1240790000	TERMSERIES, Supply module, Number of contacts: 5, , Continuous
GTIN (EAN)	4050118028164	current: 10 A, Tension-clamp connection
Qty.	10 ST	

Blank

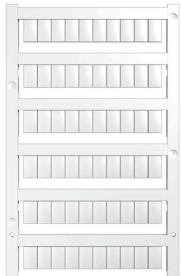

WS markers are the perfect match for the W-series connectors. Thanks to their system compatibility, the WS tags can also be used with the I-series and the Z-series. The large marking surfaces do not only permit long character strings but also multi-line text. WS markers are ideal for labels with long, customised character strings. Thanks to the proven MultiCard format, printing with PrintJet CONNECT oder/or Plotter is possible.

- Can be fitted in strips or individually
- Markers in proven MultiCard format

For custom printing: Please send us a file of our labeling software M-Print PRO or M-Print PRO Online (without installation) for your labeling specifications.

General ordering data

Type	WS 10/6 M MC NE WS	Version
Order No.	1818400000	WS, Terminal marker, 10 x 6 mm, Pitch in mm (P): 6.00 Weidmueller,
GTIN (EAN)	4032248310876	Allen-Bradley, white
Qty.	600 ST	

Crosshead screwdriver Phillips



Crosshead screwdriver, Phillips, SDK PH DIN 5262, ISO 8764/2-PH, output to ISO 8764-PH, ChromTop tip, SoftFinish grip

General ordering data

Type	SDK PHO X 60	Version
Order No.	2749400000	Screwdriver, Blade width (B): 3 mm, 60 mm, Blade thickness (A): 0
GTIN (EAN)	4050118895629	
Qty.	1 ST	
Type	SDIK PHO X 60	Version
Order No.	2749880000	Screwdriver, Blade width (B): 0 mm, 60 mm, Blade thickness (A): 0
GTIN (EAN)	4050118897081	
Qty.	1 ST	

TRS 5VDC 2CO EMPTY

Weidmüller Interface GmbH & Co. KG
 Klingenbergstraße 26
 D-32758 Detmold
 Germany

www.weidmueller.com

Accessories

Slotted screwdriver



Slotted screwdriver with rounded blade SD DIN 5265, ISO 2380/2, output to DIN 5264, ISO 2380/1. ChromTop tip, SoftFinish grip

General ordering data

Type	SDS 0.6X3.5X100	Version	
Order No.	2749340000	Screwdriver, Blade width (B): 3.5 mm, Blade length: 100 mm, Blade thickness (A): 0.6 mm	
GTIN (EAN)	4050118895568		
Qty.	1 ST		
Type	SDIS SLIM 0.6X3.5X100	Version	
Order No.	2749610000	Mounting tool, Blade width (B): 3.5 mm, Blade length: 100 mm, Blade thickness (A): 0.6 mm	
GTIN (EAN)	4050118896350		
Qty.	1 ST		

Cross-connections



Adjustable cross-connections

Increase the flexibility of your cross-connections. The TERMSERIES CROSS-CONNECTION (TCC) enables individually adjustable cross-connections with up to 51 poles. The maximum number of pluggable poles has been increased to 32 poles. The strip material can be shortened to the required length very easily. The cross-connectors convince thanks to their easy handling and visibility as well as their universal connection possibilities. An additional web prevents the spring from deforming during assembly.

- Individually adjustable cross-connection with 51 poles
- Additional bar to avoid deformation of the spring
- Increased cross-connection – up to 32 poles possible
- Vibration resistance

General ordering data

Type	TCC 6.4/51 RD	Version	
Order No.	2556410000	TERMSERIES, Cross-connector	
GTIN (EAN)	4050118566925		
Qty.	10 ST		
Type	TCC 6.4/51 OR	Version	
Order No.	2556370000	TERMSERIES, Cross-connector	
GTIN (EAN)	4050118566680		
Qty.	10 ST		
Type	TCC 6.4/51 BL	Version	
Order No.	2556450000	TERMSERIES, Cross-connector	
GTIN (EAN)	4050118566963		
Qty.	10 ST		

TRS 5VDC 2CO EMPTY

Weidmüller Interface GmbH & Co. KG
 Klingenbergstraße 26
 D-32758 Detmold
 Germany

www.weidmueller.com

Accessories

Type	TCC 6.4/51 BK	Version
Order No.	2556490000	TERMSERIES, Cross-connector
GTIN (EAN)	4050118567007	
Qty.	10 ST	
Type	TCC 6.4/2 OR	Version
Order No.	2556350000	TERMSERIES, Cross-connector
GTIN (EAN)	4050118566826	
Qty.	10 ST	
Type	TCC 6.4/2 BL	Version
Order No.	2556430000	TERMSERIES, Cross-connector
GTIN (EAN)	4050118566949	
Qty.	10 ST	
Type	TCC 6.4/2 BK	Version
Order No.	2556470000	TERMSERIES, Cross-connector
GTIN (EAN)	4050118566987	
Qty.	10 ST	
Type	TCC 6.4/10 RD	Version
Order No.	2556400000	TERMSERIES, Cross-connector
GTIN (EAN)	4050118566918	
Qty.	10 ST	
Type	TCC 6.4/10 OR	Version
Order No.	2556360000	TERMSERIES, Cross-connector
GTIN (EAN)	4050118566673	
Qty.	10 ST	
Type	TCC 6.4/10 BL	Version
Order No.	2556440000	TERMSERIES, Cross-connector
GTIN (EAN)	4050118566956	
Qty.	10 ST	
Type	TCC 6.4/10 BK	Version
Order No.	2556480000	TERMSERIES, Cross-connector
GTIN (EAN)	4050118566994	
Qty.	10 ST	
Type	TCC 12.8/26 RD	Version
Order No.	2556420000	TERMSERIES, Cross-connector
GTIN (EAN)	4050118566932	
Qty.	10 ST	
Type	TCC 12.8/26 OR	Version
Order No.	2556380000	TERMSERIES, Cross-connector
GTIN (EAN)	4050118566697	
Qty.	10 ST	
Type	TCC 12.8/26 BL	Version
Order No.	2556460000	TERMSERIES, Cross-connector
GTIN (EAN)	4050118566970	
Qty.	10 ST	
Type	TCC 12.8/26 BK	Version
Order No.	2556500000	TERMSERIES, Cross-connector
GTIN (EAN)	4050118567014	
Qty.	10 ST	
Type	TCC 6.4/2 RD	Version
Order No.	2556390000	TERMSERIES, Cross-connector
GTIN (EAN)	4050118566901	
Qty.	10 ST	

TRS 5VDC 2CO EMPTY

Weidmüller Interface GmbH & Co. KG

Klingenbergstraße 26

D-32758 Detmold

Germany

www.weidmueller.com

Accessories

Interface adapters

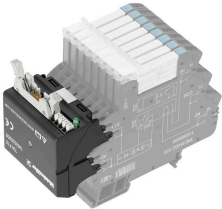

Faster signal wiring with less space

To reduce wiring times, pre-assembled cables are used between the control system and the interface level and are simply connected to the TERM SERIES adapter. This enables throughput times in electrical cabinet building to be significantly reduced. The adapter has a universal fit and offers a genuine space advantage in interaction with the TERM SERIES products with identical contours.

- Reduced wiring time due to plug-and-play concept with pre-assembled cables
- Can be applied to the input and output sides of the TERM SERIES
- Ready for plus and minus switching logic
- High space-saving due to universal fit to other TERM SERIES products

General ordering data

Type	TIAL F10	Version
Order No.	1463540000	TERM SERIES, Adapter, 10-pole plug according to DIN EN 60603-13,
GTIN (EAN)	4050118323559	long locking lever, Number of signal paths: 8, Rated voltage DC : 24 V,
Qty.	1 ST	Rated current (per signal path): 125 mA

Blank

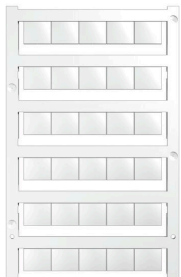

WS markers are the perfect match for the W-series connectors. Thanks to their system compatibility, the WS tags can also be used with the I-series and the Z-series. The large marking surfaces do not only permit long character strings but also multi-line text.

WS markers are ideal for labels with long, customised character strings. Thanks to the proven MultiCard format, printing with PrintJet CONNECT oder/or Plotter is possible.

- Can be fitted in strips or individually
- Markers in proven MultiCard format

For custom printing: Please send us a file of our labeling software M-Print PRO or M-Print PRO Online (without installation) for your labeling specifications.

General ordering data

Type	WS 10/12 MC NE WS	Version
Order No.	1905970000	WS, Terminal marker, 10 x 12 mm, Pitch in mm (P): 12.00
GTIN (EAN)	4032248528127	Weidmueller, white
Qty.	300 ST	

TRS 5VDC 2CO EMPTY

Weidmüller Interface GmbH & Co. KG
 Klingenbergstraße 26
 D-32758 Detmold
 Germany

www.weidmueller.com

Accessories

WS 12/6



WS/ DEK

MultiMark terminal markers use an innovative composite material made from two components. The hard base contour of the marker snaps securely into the connector. The elastic surface finish makes the marker easy to mount. This specially punched material enables the strips to be stretched to accommodate the slight variations in spacing that tend to add up, especially with long terminal blocks. Another advantage: the excellent printability of the surface material guarantees durable and wear-resistant labelling. A print resolution of 300 dpi also produces a very legible script.

Your benefits with MultiMark

- Firm hold and durable printing
- Continuous strips save installation time
- Easy mounting thanks to an innovative composite material
- Large label field for optimal legibility
- High flexibility thanks to manufacturer independence

General ordering data

Type	WS 12/6 MM WS	Version	
Order No.	2007200000		WS, Terminal marker, 12 x 6 mm, Weidmueller, white
GTIN (EAN)	4050118391886		
Qty.	600 ST		