

## Data Sheet | Item Number: 256-408/333-000

PCB terminal block; finger-operated levers; 2.5 mm<sup>2</sup>; Pin spacing 5/5.08 mm; 8-pole;  
CAGE CLAMP®; commoning option; gray

<https://www.wago.com/256-408/333-000>



Color: ■ gray

Similar to illustration

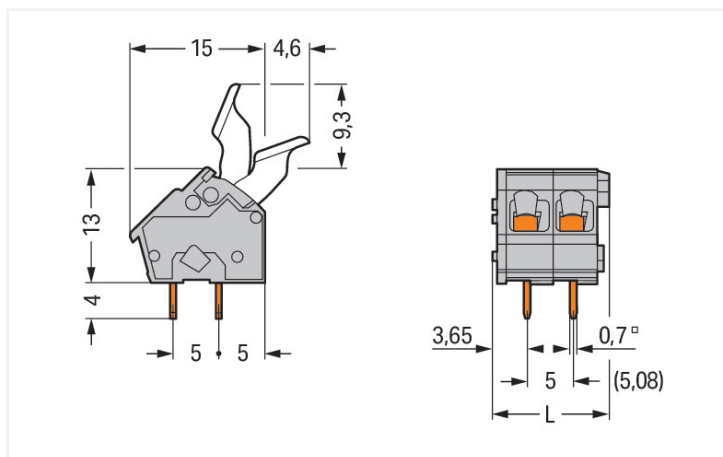
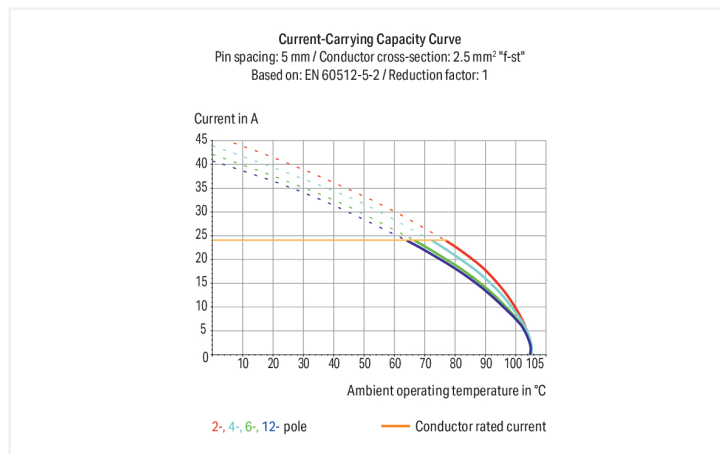

Dimensions in mm

$L = (\text{pole no.} \times \text{pin spacing}) + 2.9 \text{ mm}$  For lengths greater than three poles, finger lever operation for center levers may not be possible due to finger size/spacing limitations.

PCB terminal block, 256 Series, CAGE CLAMP®

Our PCB terminal block (item number 256-408/333-000) makes connections quick and easy. It offers the flexibility needed for different mounting types. Ensure that the strip lengths are between 5 and 6 mm when connecting conductors to this PCB terminal block. This product features one conductor terminal and utilizes CAGE CLAMP®. Our CAGE CLAMP® connection provides a convenient and maintenance-free way to connect all types of conductors. You do not need to prepare the conductor in any way, such as crimping ferrules. The item's dimensions are (42.9 x 26.3 x 19.6) mm (width x height x depth). This PCB terminal block is suitable for conductor cross sections ranging from 0.08 mm<sup>2</sup> to 2.5 mm<sup>2</sup>.

Tin is used for coating the contact surfaces. Finger-operated lever is used to operate this PCB terminal block. THT is used to assemble the PCB terminal block. Insert the conductor at an angle of 45°.

## Notes

Variants:

Other pole numbers  
 Versions for Ex e II and Ex i  
 Other colors  
 Mixed-color PCB connector strips  
 Direct marking  
 Other versions (or variants) can be requested from WAGO Sales or configured at <https://configurator.wago.com/>.

## Electrical data

Ratings per	IEC/EN 60664-1		
Overvoltage category	III	III	II
Pollution degree	3	2	2
Nominal voltage	250 V	320 V	630 V
Rated impulse withstand voltage	4 kV	4 kV	4 kV
Rated current	24 A	24 A	24 A

Approvals per	UL 1059		
Use group	B	C	D
Rated voltage	300 V	-	300 V
Rated current	15 A	-	10 A

Approvals per	CSA		
Use group	B	C	D
Rated voltage	300 V	-	300 V
Rated current	15 A	-	10 A

## Connection Data

Clamping units	8
Total number of potentials	8
Number of connection types	1
Number of levels	1

Connection 1	
Connection technology	CAGE CLAMP®
Actuation type	Finger-operated lever
Solid conductor	0.08 ... 2.5 mm <sup>2</sup> / 28 ... 12 AWG
Fine-stranded conductor	0.08 ... 2.5 mm <sup>2</sup> / 28 ... 12 AWG
Fine-stranded conductor; with insulated ferrule	0.25 ... 1.5 mm <sup>2</sup>
Fine-stranded conductor; with uninsulated ferrule	0.25 ... 1.5 mm <sup>2</sup>
Note (conductor cross-section)	12 AWG: THHN, THWN
Strip length	5 ... 6 mm / 0.2 ... 0.24 inches
Conductor connection direction to PCB	45°
Pole number	8

## Physical data

Pin spacing	5/5.08 mm / 0.197/0.2 inches
Width	42.9 mm / 1.689 inches
Height	26.3 mm / 1.035 inches
Height from the surface	22.3 mm / 0.878 inches
Depth	19.6 mm / 0.772 inches
Solder pin length	4 mm
Solder pin dimensions	0.7 x 0.7 mm
Drilled hole diameter	1.1 (+0.1) mm

### PCB contact

PCB contact	THT
Solder pin arrangement	over the entire terminal strip (in-line)
Number of solder pins per potential	2

### Material data

Note (material data)	<a href="#">Information on material specifications can be found here</a>
Color	gray
Material group	I
Insulation material (main housing)	Polyamide (PA66)
Flammability class per UL94	V0
Clamping spring material	Chrome-nickel spring steel (CrNi)
Contact material	Electrolytic copper (E <sub>Cu</sub> )
Contact Plating	Tin
Fire load	0.108 MJ
Weight	7.9 g

### Environmental requirements

Limit temperature range	-60 ... +105 °C
-------------------------	-----------------

### Commercial data

PU (SPU)	100 (25) pcs
Packaging type	Box
Country of origin	CH
GTIN	4055143320337
Customs tariff number	85369010000

### Product Classification

UNSPSC	39121409
eCl@ss 10.0	27-44-04-01
eCl@ss 9.0	27-44-04-01
ETIM 9.0	EC002643
ETIM 10.0	EC002643
ECCN	NO US CLASSIFICATION

### Environmental Product Compliance

RoHS Compliance Status	Compliant, No Exemption
------------------------	-------------------------

### Approvals / Certificates

#### Approvals for marine applications



Approval	Standard	Certificate Name
DNV DNV GL SE	-	TAE000016Z
PRS Polski Rejestr Statków	-	TE/1095/880590/23

**Downloads**

**Environmental Product Compliance**

Compliance Search	
Environmental Product Compliance 256-408/333-000	↓

**Documentation**

Additional Information			
Technical Section	03.04.2019	pdf 2027.26 KB	↓
Gebrückte Klemmenleis- ten für Leiterplatten		pdf 303.71 KB	↓

**CAD/CAE-Data**

CAD data	
2D/3D Models 256-408/333-000	↓

CAE data	
ZUKEN Portal 256-408/333-000	↓

**PCB Design**

Symbol and Footprint via SamacSys 256-408/333-000	↓
Symbol and Footprint via Ultra Librarian 256-408/333-000	↓

**1 Compatible Products**

**1.1 Optional Accessories**

**1.1.1 Ferrule**

**1.1.1.1 Ferrule**

<p><b>Item No.: 216-321</b> Ferrule; Sleeve for 0.25 mm<sup>2</sup> / AWG 24; insulated; electro-tin plated; yellow</p>	<p><b>Item No.: 216-151</b> Ferrule; Sleeve for 0.25 mm<sup>2</sup> / AWG 24; uninsulated; electro-tin plated; silver-colored</p>	<p><b>Item No.: 216-322</b> Ferrule; Sleeve for 0.34 mm<sup>2</sup> / 22 AWG; insulated; electro-tin plated; light turquoise</p>	<p><b>Item No.: 216-152</b> Ferrule; Sleeve for 0.34 mm<sup>2</sup> / 22 AWG; uninsulated; electro-tin plated; silver-colored</p>
<p><b>Item No.: 216-221</b> Ferrule; Sleeve for 0.5 mm<sup>2</sup> / 20 AWG; insulated; electro-tin plated; white</p>	<p><b>Item No.: 216-121</b> Ferrule; Sleeve for 0.5 mm<sup>2</sup> / AWG 22; uninsulated; electro-tin plated; silver-colored</p>	<p><b>Item No.: 216-222</b> Ferrule; Sleeve for 0.75 mm<sup>2</sup> / 18 AWG; insulated; electro-tin plated; gray</p>	<p><b>Item No.: 216-122</b> Ferrule; Sleeve for 0.75 mm<sup>2</sup> / 18 AWG; uninsulated; electro-tin plated; silver-colored</p>
<p><b>Item No.: 216-223</b> Ferrule; Sleeve for 1 mm<sup>2</sup> / AWG 18; insulated; electro-tin plated; red</p>	<p><b>Item No.: 216-123</b> Ferrule; Sleeve for 1 mm<sup>2</sup> / AWG 18; uninsulated; electro-tin plated; silver-colored</p>	<p><b>Item No.: 216-224</b> Ferrule; Sleeve for 1.5 mm<sup>2</sup> / AWG 16; insulated; electro-tin plated; black</p>	<p><b>Item No.: 216-124</b> Ferrule; Sleeve for 1.5 mm<sup>2</sup> / AWG 16; uninsulated; electro-tin plated</p>

## Installation Notes

### Conductor termination

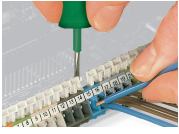

Inserting/removing a conductor – 256 Series.

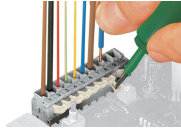

Inserting/removing a conductor (255 Series)

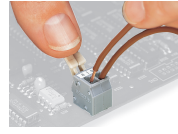

Inserting/removing a conductor via finger-operated lever – 255 Series.

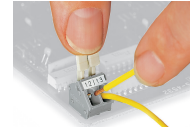

Inserting/removing a conductor via finger-operated lever – 256 Series.

## Installation



Possible conductor arrangement with terminal strips staggered (for 256 Series only).

## Marking



Formation of groups using housings of different colors

## Testing

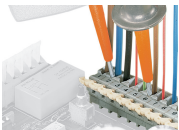

Testing with test probes.



Testing with test plug modules.