

Part Number : [5019122790](#)

Product Description : 0.30mm Pitch Easy-On FPC Connector, Right-Angle, Surface Mount, Bottom Contact Style, 1.80mm Mated Height, 27 Circuits

Series Number : 501912

Status : Obsolete

Product Category : FFC / FPC Connectors

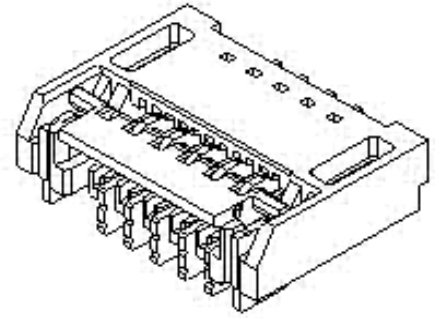

Documents and Resources

Drawings

[5019122790_sd.pdf](#)

Specifications

[PS-501912-001-001.pdf](#)

Product Environment Compliance

Compliance

GADSL/IMDS	Compliant with Exemption 44; 33
China RoHS	 per SJ/T 11365-2006
EU ELV	Product not active
Low-Halogen Status	Product not active
REACH SVHC	Not Contained per D(2025)7771-DC (04 Feb 2026)
EU RoHS	Compliant per EU 2015/863

Compliance Statements

- EU RoHS
- REACH SVHC
- Low-Halogen

Industry Documents

- IPC 1752A Class C
- IPC 1752A Class D
- Molex Product Compliance Declaration
- IEC-62474
- chemSHERPA (xml)

Substances of Interest

- PFAS

EU RoHS Certificate of Compliance

Additional Product Compliance Information

Part Details

General

Status	Obsolete
Category	FFC / FPC Connectors
Series	501912
Description	0.30mm Pitch Easy-On FPC Connector, Right-Angle, Surface Mount, Bottom Contact Style, 1.80mm Mated Height, 27 Circuits
Comments	Pattern layout, Size Different
Product Name	Easy-On
UPC	800756820088

Electrical

Current - Maximum per Contact	0.2A
Voltage - Maximum	50V

Physical

Actuator Type	Front Flip
Circuits (Loaded)	27
Color - Resin	Black, Natural
Contact Position	Bottom
Durability (mating cycles max)	20
Mated Height	1.80mm
Material - Metal	Copper, Phosphor Bronze
Material - Plating Mating	Gold
Material - Plating Termination	Gold
Material - Resin	High Temperature Thermoplastic
Net Weight	130.196/mg
Orientation	Right Angle
Packaging Type	Embossed Tape on Reel

PCB Locator	No
PCB Mounting	Surface Mount
PCB Retention	No
Pitch - Mating Interface	0.30mm
Pitch - Termination Interface	0.30mm
Plating min - Mating	0.102µm
Plating min - Termination	0.051µm
Polarized to PCB	No
Stackable	No
Temperature Range - Operating	-40° to +105°C
Wire/Cable Type	FPC only

This document was generated on Apr 15, 2026

Obsolete