

EIGHT SWITCH SERIES

8 Switch Series Selection Table

Part No.	Name	Actuator shape	Number of poles	Switching function	Terminal style	Page
8H	Lever•Rocker		1•2	ON - ON ON - OFF - ON (ON)- OFF -(ON) ON - (ON)	 S/D P/C	307
8HD	Lever•Rocker (Dust Proof)		1•2		 S/D P/C	309
8M	Small Lever Rocker		1•2•3•4		 S/D	311
8V-M	Small Lever•Rocker PC		1•2		 P/C	313

●P/C : Show PC terminal.

8 Switch Series Common Specifications

Contact specs.		Silver	Gold plated
Rating	Max.	125 VAC 6A 250 VAC 3A 30 VAC 4A	125 VAC 6 A 250 VAC 3 A 30 VDC 4 A 20 VDC 25mA
Initial contact resistance		10 mΩ Max. (2~4 VDC 1 A)	20 mΩ Max. (200 μVAC 1.5 mA)
Initial dielectric strength		AC1500V/Minute	
Initial insulation resistance		1000 MΩ Min. (500 VDC)	
Electrical life	Alternate type	50,000/cycles	
	Momentary type	25,000/cycles	
Operating temperature range		-30~+85°C	
Storage temperature range		-40~+85°C	

Terminal Styles

Terminal style	Solder Lug (Style : 1)	PC Straight (Style : 2)
Dimensions		

PC Hole Layouts

Dimensions	
------------	--

(ON) : Momentary.

8 switch series

Part Numbering

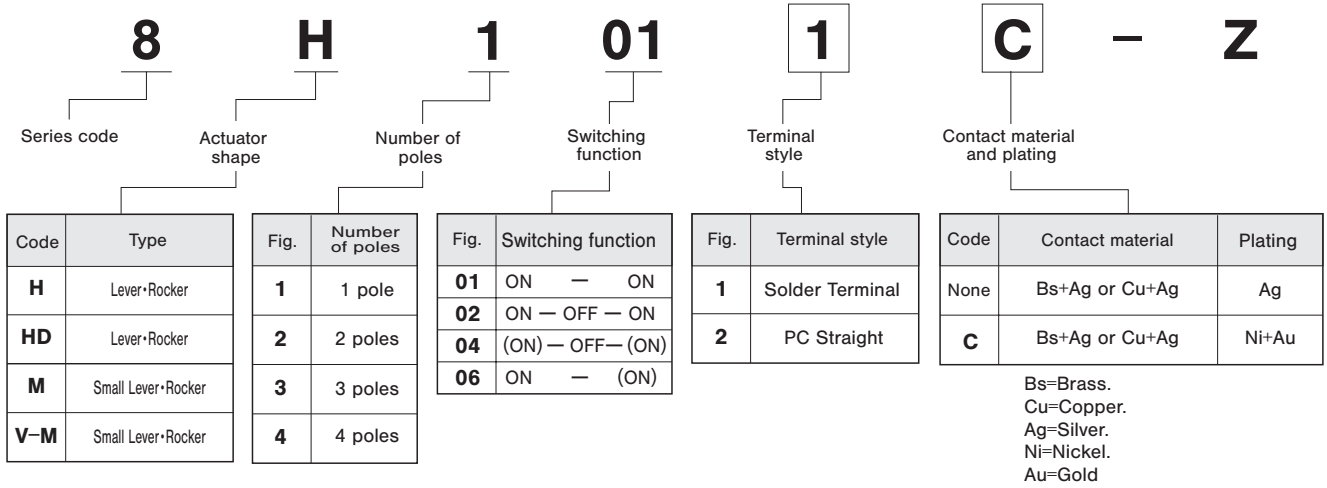

Note : For some products, the part numbers according to the above-stated combinations are not registered yet. Check the Table of Part Numbers for availability.

8H

Lever & Rocker Switches

RoHS Compliant



■ Features

The 8H Lever & Rocker Switches feature the snap-in mount type on the panel, which enables side-by-side mounting. For the actuator, either of the lever or the rocker can be chosen according to applications and four colors are available for the actuator and the mounting frame, respectively. Choose the suitable one for the panel design.

SPDT

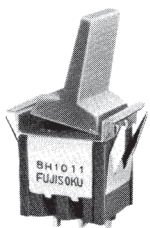

(Mount with lever)

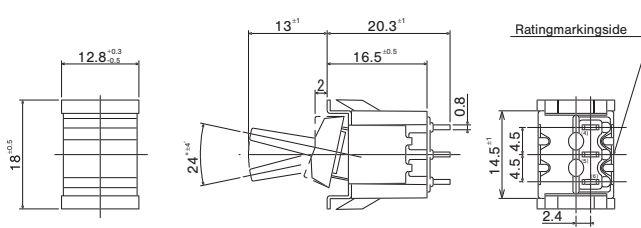

Terminal numbers are not shown on the bottom of the switch.

Switching function Part No.	Viewed from rating marking side		
8H101 ■-Z	ON	-	ON
8H102 ■-Z	ON	OFF	ON
8H104 ■-Z	(ON)	OFF	(ON)
8H106 ■-Z	ON	-	(ON)
Connecting terminals	5-6	-	5-4

■ : Look at follows.

DPDT

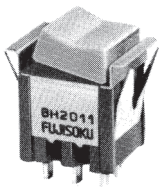

(Mount with rocker)

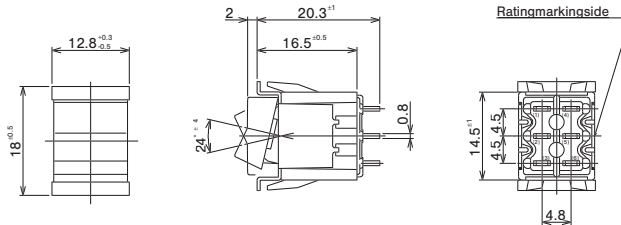

Terminal numbers are not shown on the bottom of the switch.

Switching function Part No.	Viewed from rating marking side		
8H201 ■-Z	ON	-	ON
8H202 ■-Z	ON	OFF	ON
8H204 ■-Z	(ON)	OFF	(ON)
8H206 ■-Z	ON	-	(ON)
Connecting terminals	2-3 5-6	-	2-1 5-4

■ : Look at follows.

■ Table of Part Numbers

Terminal style	Switching function	1 pole	2 poles
Solder Terminal	ON - ON	☆ 8H1011-Z ☆ 8H1011C-Z	8H2011-Z
	ON - OFF - ON (ON) - OFF - (ON)	☆ 8H1021-Z 8H1041-Z	★ 8H2021-Z ★ 8H2041-Z
	ON - (ON)	8H1061-Z	—
PC Straight	ON - ON	★ 8H1012-Z	★ 8H2012-Z
	ON - (ON)	—	★ 8H2062-Z

■ Handling Precautions

1. Soldering Specifications

- (1) Soldering Specifications
Device: Soldering iron
① 420°C, Max.; 3 sec., Max.

- (2) Auto Soldering

- ② 275°C ± 10°C, Max.; 5 seconds, Max.

Note that the above-stated soldering conditions should be applied to the PC terminal type only.

2. Flux Cleaning

- (1) For the solvent, use the fluorine- or alcohol-based solvent.

Solvent: Fluorine or Alcohol type

- (2) Since the 8H Series are not waterproof-structured, if the PC board is to be cleaned, clean the soldering surface of substrate with a brush so that the switch is not exposed to the cleaning solution.

(ON) : Momentary.

★ : Made to order products.

☆ : Semi-standard products.

Panel Cut-Out Dimensions

Panel thickness (With mounting frame) : 1 to 2.5mm

Panel thickness (Without mounting frame) : 1 to 3mm

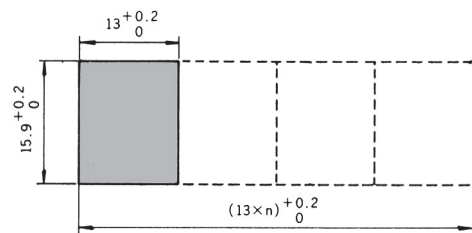
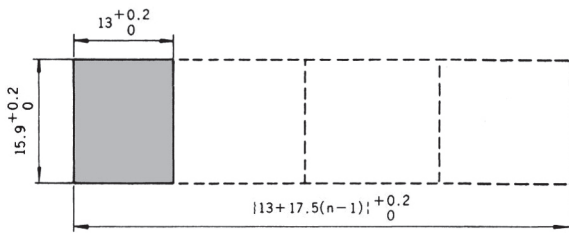

Lever •Rocker Installation Procedure

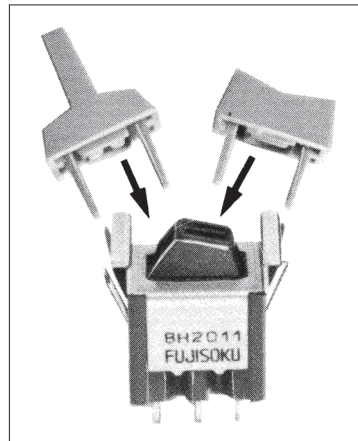

Mounting Frame mounting Method

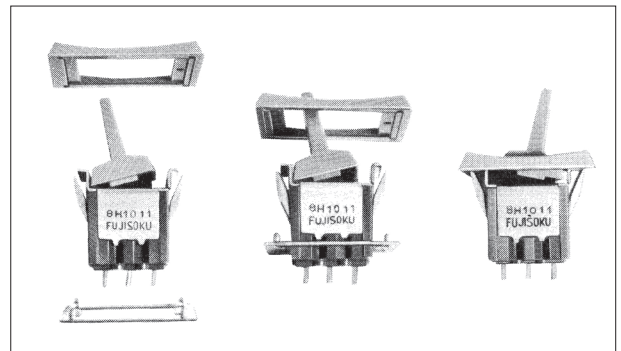

Accessories

(Supplied separately)

Part Name	Standard Accessories		Optional Accessories
	Lever	Rocker	Mounting Frame
Gloss finish Dimensions (Polyacetal resin)			
White	14000050693	140000480332	140000340086+140000600181
Red	—	140000480334	140000340087+140000600181
Black	14000050695	140000480333	140000340088+140000600181
Gray	—	—	140000340089+140000600181

● Specify either one of Lever or Rocker in part number when placing an order.

PC Hole Layouts

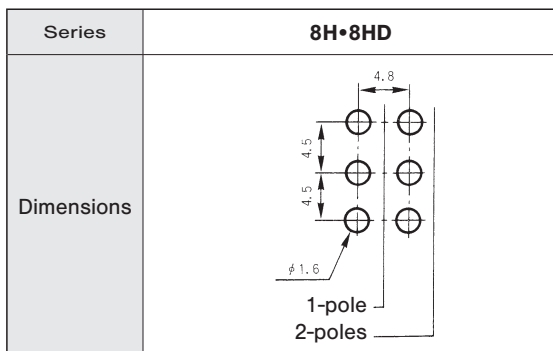

Terminal Styles

Series	8H•8HD	
Terminal style	Solder Terminal (Style : 1)	PC Straight (Style : 2)
Dimensions		

Optional Accessories. (ON) : Momentary.