

#### INTRODUCTION:

Adam Tech PCE & PCD Series receptacles are PCB mounted sockets that have integral PC Board hooks which wrap around the edge of the PCB for added stability. They are made with three mounting and mating configurations which include Top, Bottom & Side entry. Offered in pitches of .100" & .156" they contain a high reliability contact system that offers superior connectivity through a set of long, wide, precision stamped contacts which provide ample contact pressure with a smooth wiping action.

#### FEATURES:

- .100" & .156" Centerlines
- Hooks for stability to PCB
- High normal force contacts
- Low insertion force
- Three mounting orientation options

#### MATING HEADERS:

Adam Tech PH & LHB headers and all industry standard .100" and .156" pitch pin headers with a .025" or .045" square or round pins

#### SPECIFICATIONS:

##### Material:

Insulator: Nylon 66, rated UL94V-0  
Insulator Color: Natural  
Contacts: Phosphor Bronze

##### Contact Plating:

Tin over copper underplate overall

##### Electrical:

Operating voltage: 250V AC max.  
Current rating: .100 pitch: 3 Amp max.  
.156 pitch: 7 Amps max.  
Contact resistance: 10 mΩ max. Initial  
Insulation resistance: 1000 MΩ min.  
Dielectric withstanding voltage: 1500V AC for 1 minute

##### Mechanical:

Insertion force: 0.375 lbs max  
Withdrawal force: 0.187 lbs min.  
Recommended PCB Thickness: 0.063" (1.6mm]

##### Temperature Rating:

Operating temperature: -40°C to +105°C

##### PACKAGING:

Anti-ESD plastic trays

##### SAFETY AGENCY APPROVALS:

UL Recognized & CSA Certified, File no. E224053

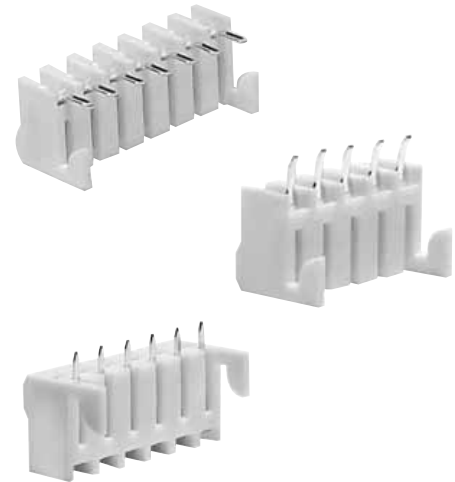

#### ORDERING INFORMATION

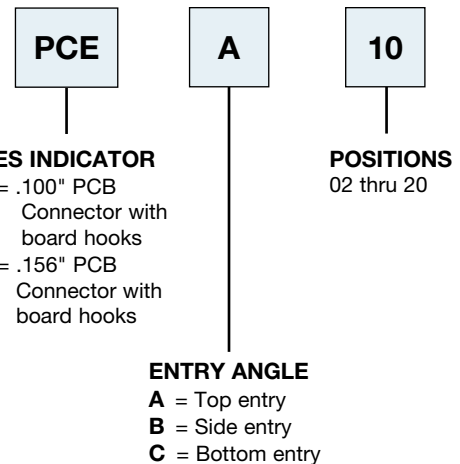

#### OPTIONS

Add designator(s) to end of part number  
NH = No Board hooks



### PCE-A

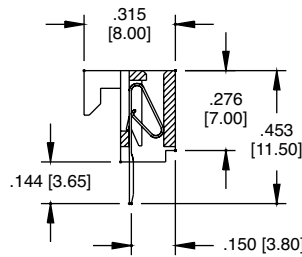
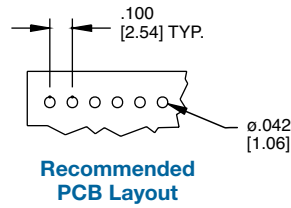
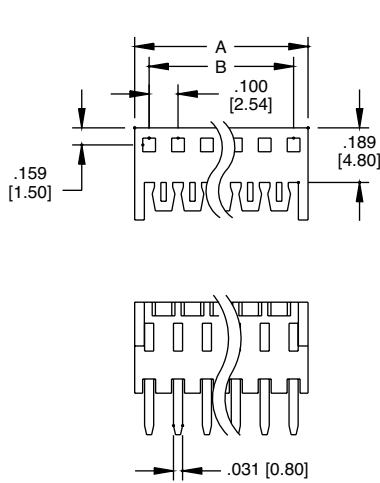

**TOP ENTRY  
PCE-A-05**

A = .100 [2.54] x No. of Positions  
B = .100 [2.54] x No. of Spaces

### PCE-B

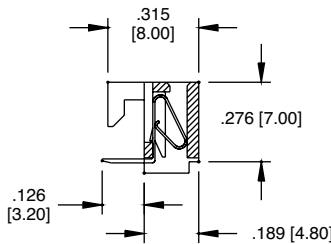
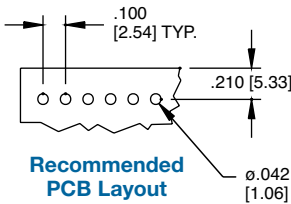
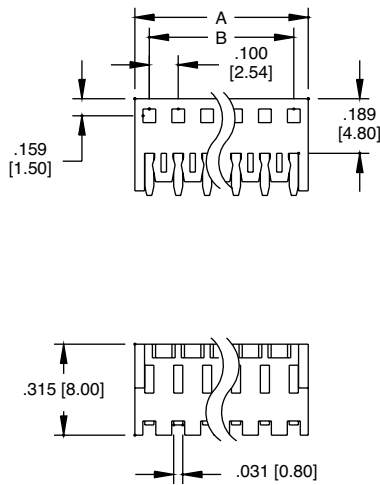

**SIDE ENTRY  
PCE-B-07**

A = .100 [2.54] x No. of Positions  
B = .100 [2.54] x No. of Spaces

### PCE-C

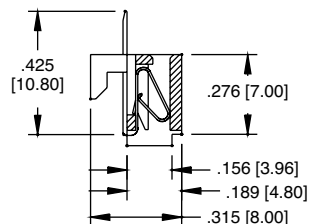
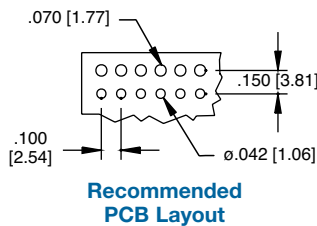
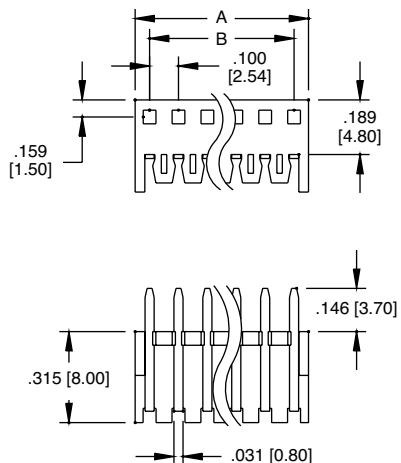

**BOTTOM ENTRY  
PCE-C-06**

A = .100 [2.54] x No. of Positions  
B = .100 [2.54] x No. of Spaces