

Data Sheet | Item Number: 2091-1110/002-000

1-conductor female connector; push-button; Push-in CAGE CLAMP®; 1.5 mm²; Pin spacing 3.5 mm; 10-pole; Gripping plate sliding connector release; 1,50 mm²; light gray

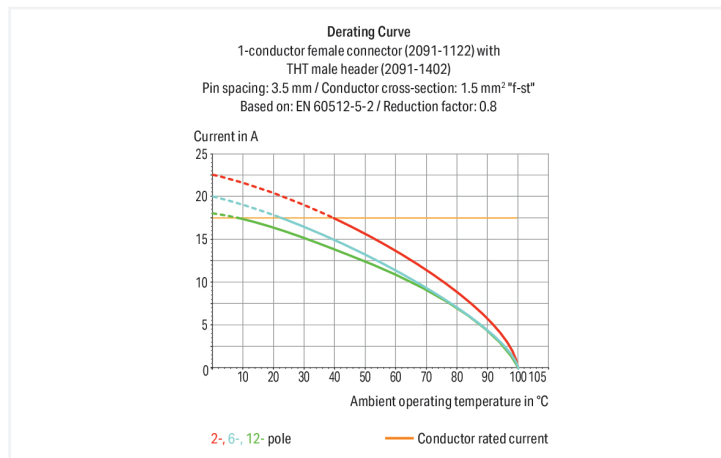

<https://www.wago.com/2091-1110/002-000>



Color: ■ light gray

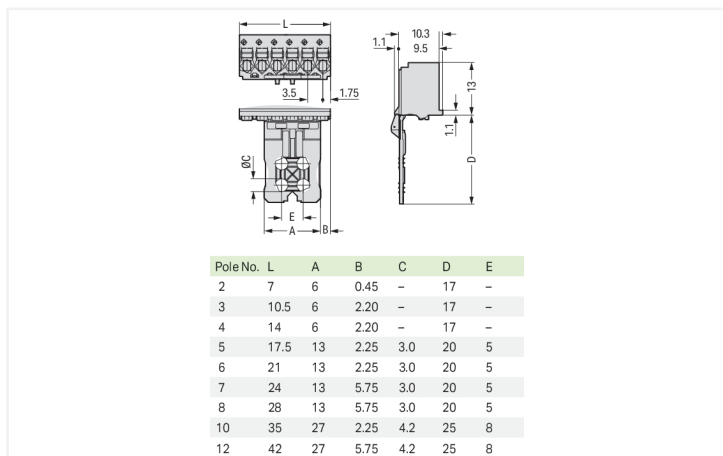

Dimensions in mm

Female connector, 2091 Series, light gray

Error-free electrical installations are guaranteed with this female connector (item number 2091-1110/002-000). Ensure that the strip lengths are between 8 and 9 mm when connecting conductors to this female connector. This product features one conductor terminal and utilizes Push-in CAGE CLAMP®. Our Push-in CAGE CLAMP® is a universal, maintenance-free connection solution for all conductor types, offering a key advantage: It allows direct insertion of both solid and fine-stranded conductors with ferrules without needing tools. No preparation is required; for example, crimping the conductor's ferrule is not necessary. The dimensions are (35 x 39 x 12.4) mm (width x height x depth). This female connector is suitable for conductor cross sections ranging from 0.2 mm² to 1.5 mm².

Tin is used for coating the contact surfaces.

Notes

Safety Information

The **picoMAX® Pluggable Connection System** includes connectors without breaking capacity in accordance with DIN EN 61984. When used as intended, these connectors must not be connected/disconnected when live or under load. When used as intended, these connectors must not be connected/disconnected when live or under load. The circuit design should ensure header pins, which can be touched, are not live when un-mated.

Safety information 2

The use of ferrules is recommended for applications with higher requirements.

To prevent excessive force on the clamping point, effective cable strain relief must be used.

Variants:

Direct marking

Other versions (or variants) can be requested from WAGO Sales or configured at <https://configurator.wago.com/>.

Electrical data

Ratings per	IEC/EN 60664-1			Approvals per	UL 1059		
	III	III	II		Use group	B	C
Overvoltage category	III	III	II	Use group	B	C	D
Pollution degree	3	2	2	Rated voltage	300 V	-	300 V
Nominal voltage	160 V	160 V	320 V	Rated current	10 A	-	10 A
Rated impulse withstand voltage	2.5 kV	2.5 kV	2.5 kV				
Rated current	10 A	10 A	10 A				

Connection Data

Clamping units	10	Connection 1	Connection technology	Push-in CAGE CLAMP®
Total number of potentials	10		Actuation type	Push-button
Number of connection types	1		Actuation direction 1	Operation parallel to conductor entry
Number of levels	1		Solid conductor	0.2 ... 1.5 mm ² / 24 ... 14 AWG
		Fine-stranded conductor	0.2 ... 1.5 mm ² / 24 ... 14 AWG	
		Fine-stranded conductor; with insulated ferrule	0.25 ... 0.75 mm ²	
		Fine-stranded conductor; with uninsulated ferrule	0.25 ... 1.5 mm ²	
		Strip length	8 ... 9 mm / 0.31 ... 0.35 inches	
		Pole number	10	

Physical data

Pin spacing	3.5 mm / 0.138 inches
Width	35 mm / 1.378 inches
Height	39 mm / 1.535 inches
Depth	12.4 mm / 0.488 inches

Mechanical data

Variable coding	Yes
Design	with gripping plate and sliding connector release
Anti-rotation protection	Yes

Plug-in connection

Contact type (pluggable connector)	Female connector/socket
Connector (connection type)	for conductor
Mismatching protection	No
Plugging without loss of pin spacing	Yes

Material data

Note (material data)	Information on material specifications can be found here
Color	light gray
Material group	I
Insulation material (main housing)	Polyphthalamide (PPA GF)
Flammability class per UL94	V0
Clamping spring material	Chrome-nickel spring steel (CrNi)
Contact material	Electrolytic copper (E _{Cu})
Contact Plating	Tin
Fire load	0.069 MJ
Weight	5.1 g

Environmental requirements

Limit temperature range	-60 ... +100 °C
Processing temperature	-35 ... +60 °C

Commercial data

PU (SPU)	50 pcs
Packaging type	Box
Country of origin	DE
GTIN	4050821411680
Customs tariff number	85366990990

Product Classification

UNSPSC	39121409
eCl@ss 10.0	27-14-11-06
eCl@ss 9.0	27-14-11-06
ETIM 9.0	EC001284
ETIM 10.0	EC001284
ECCN	NO US CLASSIFICATION

Environmental Product Compliance

RoHS Compliance Status	Compliant, No Exemption
------------------------	-------------------------

Approvals / Certificates

General approvals



Approval	Standard	Certificate Name
CB DEKRA Certification B.V.	IEC 61984	NL-89884
CSA CSA Group	C22.2	2362521
CSA DEKRA Certification B.V.	C22.2 No. 158	2362521
KEMA/KEUR DEKRA Certification B.V.	EN 61984	71-129873
UR Underwriters Laboratories Inc.	UL 1059	E45172

Downloads

Environmental Product Compliance

Compliance Search

Environmental Product Compliance 2091-1110/002-000	↓
---	---

Documentation

Additional Information

Technical Section	03.04.2019	pdf 2027.26 KB	↓
-------------------	------------	-------------------	---

CAD/CAE-Data

CAD data

2D/3D Models 2091-1110/002-000	↓
-----------------------------------	---

CAE data

ZUKEN Portal 2091-1110/002-000	↓
-----------------------------------	---

1 Compatible Products

1.1 System counterpart

1.1.1 Male connector/plug



Item No.: 2091-1430

THT male header; 1.0 mm Ø solder pin; angled; Pin spacing 3.5 mm; 10-pole; light gray

Item No.: 2091-1410

THT male header; 1.0 mm Ø solder pin; straight; Pin spacing 3.5 mm; 10-pole; light gray

1.2 Optional Accessories

1.2.1 Coding

1.2.1.1 Coding



Item No.: 2091-1610

Coding key carrier; suitable for 3.5 mm pin spacing; orange

1.2.2 Ferrule

1.2.2.1 Ferrule



Item No.: 216-301

Ferrule; Sleeve for 0.25 mm² / AWG 24; insulated; electro-tin plated; yellow



Item No.: 216-131

Ferrule; Sleeve for 0.25 mm² / AWG 24; uninsulated; electro-tin plated; silver-colored



Item No.: 216-302

Ferrule; Sleeve for 0.34 mm² / 22 AWG; insulated; electro-tin plated; light turquoise



Item No.: 216-132

Ferrule; Sleeve for 0.34 mm² / 22 AWG; uninsulated; electro-tin plated



Item No.: 216-101

Ferrule; Sleeve for 0.5 mm² / AWG 22; uninsulated; electro-tin plated; silver-colored



Item No.: 216-202

Ferrule; Sleeve for 0.75 mm² / 18 AWG; insulated; electro-tin plated; gray



Item No.: 216-102

Ferrule; Sleeve for 0.75 mm² / AWG 20; uninsulated; electro-tin plated; silver-colored



Item No.: 216-122

Ferrule; Sleeve for 0.75 mm² / AWG 20; uninsulated; electro-tin plated; silver-colored



Item No.: 216-203

Ferrule; Sleeve for 1 mm² / AWG 18; insulated; electro-tin plated; red



Item No.: 216-103

Ferrule; Sleeve for 1 mm² / AWG 18; uninsulated; electro-tin plated



Item No.: 216-204

Ferrule; Sleeve for 1.5 mm² / AWG 16; insulated; electro-tin plated; black



Item No.: 216-104

Ferrule; Sleeve for 1.5 mm² / AWG 16; uninsulated; electro-tin plated; silver-colored

1.2.3 Test and measurement

1.2.3.1 Testing accessories



Item No.: 735-500

WAGO Test pin; 1 mm Ø; 30 V AC / 60 V DC; CAT0; 1 A; 6 mm uninsulated; Test lead for soldering up to 0,5mm²

1.2.4 Tool

1.2.4.1 Operating tool



Item No.: 210-719

Operating tool; Blade: 2.5 x 0.4 mm; with a partially insulated shaft

Installation Notes

Locking system

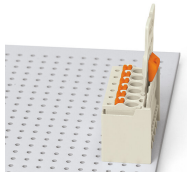

Male header mated to a female connector with gripping plate and sliding connector release.

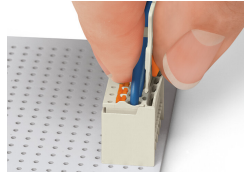

Push down sliding connector release (gripping plate) to open the locking latch.

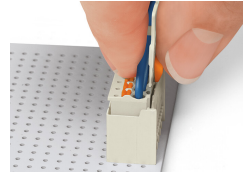

Pull out female connector from male header.

Conductor termination

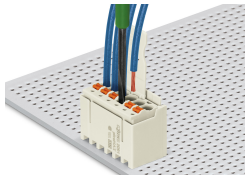

Inserting fine-stranded conductor into mated female connector via push-button.



Inserting a fine-stranded conductor into an unmated female connector via push-button.

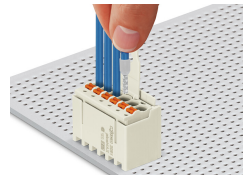

Inserting solid and ferruled conductors via push-in termination.

Marking



Pole marking via factory direct marking.

Coding



Coding a female connector (via coding key carrier and two keys for female connector, see symbol).

Testing



Testing via 1 mm Ø test pin – touch contact.