

# HMOV™ Varistor Series

## Radial Leaded Varistors



### Description

The HMOV™ Varistor Series is specifically designed for applications requiring high surge energy absorption and high operating temperature of 125°C.

The maximum peak surge current is rated up to 10kA (8/20µs pulse) to protect against indirect lightning strikes, switching surge transients, and abnormally fast transients.

### Features & Benefits

- High operating temperature combined with high isolation voltage capability: 125°C and 2500V, respectively
- High surge current withstanding capability up to 10kA (8/20µs pulse)
- Complies with 1000 cycle, -55°C to 125°C, Thermal Shock Cycling Test
- Wide operating voltage range
- Three disc sizes available: 10mm, 14mm, and 20mm
- Lead-free, Halogen-free, and RoHS compliant

### Additional Information



Resources



Accessories



Samples

### Agency Approvals

| Agency | Agency Approval                                | Agency File Number            |
|--------|--|-------------------------------|
|        | UL1449   | E320116                       |
|        | IEC 60950-1(Annex Q)<br>IECQ CS 042200 GB 0001 | IECQ-C BSI 15.0013<br>E1291/F |

### Applications

- LED lighting
- Security System (fire alarm or smoke detector)
- Solar Power Inverter
- Automation control
- Power Supply Unit (outdoor and industrial)

### Absolute Maximum Ratings

|  | Low Voltage Series | Units |
|--|--------------------|-------|
| <b>Continous:</b>  |                    |       |
| Steady State Applied Voltage:  |                    |       |
| AC Voltage Range ( $V_{M(AC)RMS}$ )  | 11 to 625          | V     |
| DC Voltage Range ( $V_{M(DC)}$ )   | 14 to 825          | V     |
| <b>Transient:</b>  |                    |       |
| Non-Repetitive Surge Current, 8/20µs Waveform ( $I_{TM}$ )                                     | 800 to 10,000      | A     |
| Non-Repetitive Energy Capability, 2ms Waveform ( $W_{TM}$ )                                    | 0.8 to 150         | J     |
| Operating Ambient Temperature Range ( $T_A$ )  | -55 to +125        | °C    |
| Storage Temperature Range ( $T_{STG}$ )  | -55 to +150        | °C    |
| Temperature Coefficient ( $\alpha V$ ) of Clamping Voltage ( $V_C$ ) at Specified Test Current | < 0.01 %           | °C    |
| Hi-Pot Encapsulation (Isolation Voltage Capability)  | 2500               | V     |
| Silicone Coating Insulation Resistance   | >1,000             | MΩ    |

**Note:** See Device Ratings and Specifications chart for ratings of individual members of a series.

**Caution:** Stresses above those listed in "Absolute Maximum Ratings" may cause permanent damage to the device. This is a stress only rating and operation of the device at these or any other conditions above those indicated in the operational sections of this specification is not implied.

# HMOV™ Varistor Series

## Radial Leded Varistors

### HMOV™ Series Device Ratings and Specifications

| Silicone Coated Models  |          | Size Disc Dia. (mm) | Maximum Rating (125°C) |                    |                           |                            |                              | Specifications (25°C)   |                      |                                     |                 |                              |  |
|-------------------------|----------|---------------------|------------------------|--------------------|---------------------------|----------------------------|------------------------------|-------------------------|----------------------|-------------------------------------|-----------------|------------------------------|--|
|                         |          |                     | Max Continuous Voltage |                    | Max Peak Current (8/20µs) |                            | Energy Rating (2ms, 1 pulse) | Varistor Voltage at 1mA |                      | Maximum Clamping Voltage (8 x 20µs) |                 | Typical Capacitance f = 1MHz |  |
|                         |          |                     | V <sub>M(AC) RMS</sub> | V <sub>M(DC)</sub> | I <sub>TM</sub> 1 x Pulse | I <sub>TM</sub> 2 x Pulses | W <sub>TM</sub>              | V <sub>NOM Min</sub>    | V <sub>NOM Max</sub> | V <sub>C</sub>                      | I <sub>PK</sub> | C                            |  |
| Part Number (Base part) | Branding |                     | (V)                    | (V)                | (A)                       | (A)                        | (J)                          | (V)                     | (V)                  | (V)                                 | (A)             | (pF)                         |  |
| V10H11P                 | P10H11   | 10                  | 11                     | 14                 | 1500                      | 800                        | 4.2                          | 16.2                    | 19.8                 | 36                                  | 5               | 5450                         |  |
| V14H11P                 | P14H11   | 14                  | 11                     | 14                 | 3000                      | 1800                       | 8                            | 16.2                    | 19.8                 | 36                                  | 10              | 12000                        |  |
| V20H11P                 | P20H11   | 20                  | 11                     | 14                 | 5000                      | 3000                       | 25                           | 16.2                    | 19.8                 | 36                                  | 20              | 26000                        |  |
| V10H14P                 | P10H14   | 10                  | 14                     | 18                 | 1500                      | 800                        | 5                            | 19.8                    | 24.2                 | 43                                  | 5               | 4650                         |  |
| V14H14P                 | P14H14   | 14                  | 14                     | 18                 | 3000                      | 1800                       | 10                           | 19.8                    | 24.2                 | 43                                  | 10              | 10200                        |  |
| V20H14P                 | P20H14   | 20                  | 14                     | 18                 | 5000                      | 3000                       | 28                           | 19.8                    | 24.2                 | 43                                  | 20              | 22200                        |  |
| V10H17P                 | P10H17   | 10                  | 17                     | 22                 | 1500                      | 800                        | 6.5                          | 24.3                    | 29.7                 | 53                                  | 5               | 3900                         |  |
| V14H17P                 | P14H17   | 14                  | 17                     | 22                 | 3000                      | 1800                       | 13                           | 24.3                    | 29.7                 | 53                                  | 10              | 8700                         |  |
| V20H17P                 | P20H17   | 20                  | 17                     | 22                 | 5000                      | 3000                       | 35                           | 24.3                    | 29.7                 | 53                                  | 20              | 18750                        |  |
| V10H20P                 | P10H20   | 10                  | 20                     | 26                 | 1500                      | 800                        | 10                           | 29.7                    | 36.3                 | 65                                  | 5               | 3400                         |  |
| V14H20P                 | P14H20   | 14                  | 20                     | 26                 | 3000                      | 1800                       | 20                           | 29.7                    | 36.3                 | 65                                  | 10              | 7500                         |  |
| V20H20P                 | P20H20   | 20                  | 20                     | 26                 | 5000                      | 3000                       | 58                           | 29.7                    | 36.3                 | 65                                  | 20              | 15000                        |  |
| V10H23P                 | P10H23   | 10                  | 23                     | 28                 | 1500                      | 800                        | 12                           | 32.4                    | 39.6                 | 71                                  | 5               | 3200                         |  |
| V14H23P                 | P14H23   | 14                  | 23                     | 28                 | 3000                      | 1800                       | 23                           | 32.4                    | 39.6                 | 71                                  | 10              | 7000                         |  |
| V20H23P                 | P20H23   | 20                  | 23                     | 28                 | 5000                      | 3000                       | 70                           | 32.4                    | 39.6                 | 71                                  | 20              | 14000                        |  |
| V10H25P                 | P10H25   | 10                  | 25                     | 31                 | 1500                      | 800                        | 13                           | 35.1                    | 42.9                 | 77                                  | 5               | 2900                         |  |
| V14H25P                 | P14H25   | 14                  | 25                     | 31                 | 3000                      | 1800                       | 25                           | 35.1                    | 42.9                 | 77                                  | 10              | 6200                         |  |
| V20H25P                 | P20H25   | 20                  | 25                     | 31                 | 5000                      | 3000                       | 77                           | 35.1                    | 42.9                 | 77                                  | 20              | 13500                        |  |
| V10H30P                 | P10H30   | 10                  | 30                     | 38                 | 1500                      | 800                        | 15.5                         | 42.3                    | 51.7                 | 93                                  | 5               | 2550                         |  |
| V14H30P                 | P14H30   | 14                  | 30                     | 38                 | 3000                      | 1800                       | 32                           | 42.3                    | 51.7                 | 93                                  | 10              | 5550                         |  |
| V20H30P                 | P20H30   | 20                  | 30                     | 38                 | 5000                      | 3000                       | 90                           | 42.3                    | 51.7                 | 93                                  | 20              | 12000                        |  |
| V10H35P                 | P10H35   | 10                  | 35                     | 45                 | 1500                      | 800                        | 20                           | 50.4                    | 61.6                 | 110                                 | 5               | 2200                         |  |
| V14H35P                 | P14H35   | 14                  | 35                     | 45                 | 3000                      | 1800                       | 40                           | 50.4                    | 61.6                 | 110                                 | 10              | 5000                         |  |
| V20H35P                 | P20H35   | 20                  | 35                     | 45                 | 5000                      | 3000                       | 115                          | 50.4                    | 61.6                 | 110                                 | 20              | 10500                        |  |
| V10H40P                 | P10H40   | 10                  | 40                     | 56                 | 1500                      | 800                        | 25                           | 61.2                    | 74.8                 | 135                                 | 5               | 1850                         |  |
| V14H40P                 | P14H40   | 14                  | 40                     | 56                 | 3000                      | 1800                       | 50                           | 61.2                    | 74.8                 | 135                                 | 10              | 4000                         |  |
| V20H40P                 | P20H40   | 20                  | 40                     | 56                 | 5000                      | 3000                       | 140                          | 61.2                    | 74.8                 | 135                                 | 20              | 8500                         |  |
| V10H50P                 | P10H50   | 10                  | 50                     | 65                 | 3500                      | 3000                       | 20                           | 73.8                    | 90.2                 | 135                                 | 25              | 1400                         |  |
| V14H50P                 | P14H50   | 14                  | 50                     | 65                 | 6500                      | 5000                       | 40                           | 73.8                    | 90.2                 | 145                                 | 50              | 3000                         |  |
| V20H50P                 | P20H50   | 20                  | 50                     | 65                 | 10000                     | 7000                       | 80                           | 73.8                    | 90.2                 | 145                                 | 100             | 6000                         |  |
| V10H60P                 | P10H60   | 10                  | 60                     | 85                 | 3500                      | 3000                       | 24                           | 90                      | 110                  | 165                                 | 25              | 1200                         |  |
| V14H60P                 | P14H60   | 14                  | 60                     | 85                 | 6500                      | 5000                       | 50                           | 90                      | 110                  | 175                                 | 50              | 2500                         |  |
| V20H60P                 | P20H60   | 20                  | 60                     | 85                 | 10000                     | 7000                       | 100                          | 90                      | 110                  | 175                                 | 100             | 5200                         |  |
| V10H75P                 | P10H75   | 10                  | 75                     | 100                | 3500                      | 3000                       | 29                           | 108                     | 132                  | 200                                 | 25              | 1100                         |  |
| V14H75P                 | P14H75   | 14                  | 75                     | 100                | 6500                      | 5000                       | 60                           | 108                     | 132                  | 210                                 | 50              | 2300                         |  |
| V20H75P                 | P20H75   | 20                  | 75                     | 100                | 10000                     | 7000                       | 120                          | 108                     | 132                  | 210                                 | 100             | 4800                         |  |
| V10H95P                 | P10H95   | 10                  | 95                     | 125                | 3500                      | 3000                       | 36                           | 135                     | 165                  | 250                                 | 25              | 800                          |  |
| V14H95P                 | P14H95   | 14                  | 95                     | 125                | 6500                      | 5000                       | 75                           | 135                     | 165                  | 250                                 | 50              | 1700                         |  |
| V20H95P                 | P20H95   | 20                  | 95                     | 125                | 10000                     | 7000                       | 150                          | 135                     | 165                  | 250                                 | 100             | 3700                         |  |
| V10H115P                | P10H115  | 10                  | 115                    | 153                | 3500                      | 3000                       | 30                           | 162                     | 198                  | 300                                 | 25              | 465                          |  |
| V14H115P                | P14H115  | 14                  | 115                    | 153                | 6500                      | 5000                       | 50                           | 162                     | 198                  | 300                                 | 50              | 1190                         |  |
| V20H115P                | P20H115  | 20                  | 115                    | 153                | 10000                     | 7000                       | 120                          | 162                     | 198                  | 300                                 | 100             | 2400                         |  |
| V10H130P                | P10H130  | 10                  | 130                    | 170                | 3500                      | 3000                       | 40                           | 184.5                   | 225.5                | 340                                 | 25              | 450                          |  |
| V14H130P                | P14H130  | 14                  | 130                    | 170                | 6500                      | 5000                       | 60                           | 184.5                   | 225.5                | 340                                 | 50              | 1000                         |  |
| V20H130P                | P20H130  | 20                  | 130                    | 170                | 10000                     | 7000                       | 145                          | 184.5                   | 225.5                | 340                                 | 100             | 1900                         |  |
| V10H140P                | P10H140  | 10                  | 140                    | 180                | 3500                      | 3000                       | 45                           | 198                     | 242                  | 360                                 | 25              | 400                          |  |

Note: Average power dissipation of transients not to exceed 0.4W, 0.6W or 1W for model sizes 10mm, 14mm, and 20mm, respectively.

# HMOV™ Varistor Series

## Radial Leaded Varistors

### HMOV™ Series Device Ratings and Specifications

| Silicone Coated Models  |          | Size Disc Dia. (mm) | Maximum Rating (125°C) |                    |                           |                            |                              | Specifications (25°C)   |                      |                                     |                 |                              |
|-------------------------|----------|---------------------|------------------------|--------------------|---------------------------|----------------------------|------------------------------|-------------------------|----------------------|-------------------------------------|-----------------|------------------------------|
|                         |          |                     | Max Continuous Voltage |                    | Max Peak Current (8/20µs) |                            | Energy Rating (2ms, 1 pulse) | Varistor Voltage at 1mA |                      | Maximum Clamping Voltage (8 x 20µs) |                 | Typical Capacitance f = 1MHz |
|                         |          |                     | V <sub>M(A)C</sub> RMS | V <sub>M(DC)</sub> | I <sub>TM</sub> 1 x Pulse | I <sub>TM</sub> 2 x Pulses | W <sub>TM</sub>              | V <sub>NOM</sub> Min    | V <sub>NOM</sub> Max | V <sub>C</sub>                      | I <sub>PK</sub> | C                            |
| Part Number (Base part) | Branding | (V)                 | (V)                    | (A)                | (A)                       | (J)                        | (V)                          | (V)                     | (V)                  | (A)                                 | (pF)            |                              |
| V14H140P                | P14H140  | 14                  | 140                    | 180                | 6500                      | 5000                       | 65                           | 198                     | 242                  | 360                                 | 50              | 900                          |
| V20H140P                | P20H140  | 20                  | 140                    | 180                | 10000                     | 7000                       | 155                          | 198                     | 242                  | 360                                 | 100             | 1750                         |
| V10H150P                | P10H150  | 10                  | 150                    | 200                | 3500                      | 3000                       | 50                           | 216                     | 264                  | 395                                 | 25              | 360                          |
| V14H150P                | P14H150  | 14                  | 150                    | 200                | 6500                      | 5000                       | 70                           | 216                     | 264                  | 395                                 | 50              | 800                          |
| V20H150P                | P20H150  | 20                  | 150                    | 200                | 10000                     | 7000                       | 165                          | 216                     | 264                  | 395                                 | 100             | 1600                         |
| V10H175P                | P10H175  | 10                  | 175                    | 225                | 3500                      | 3000                       | 55                           | 243                     | 297                  | 455                                 | 25              | 350                          |
| V14H175P                | P14H175  | 14                  | 175                    | 225                | 6500                      | 5000                       | 80                           | 243                     | 297                  | 455                                 | 50              | 700                          |
| V20H175P                | P20H175  | 20                  | 175                    | 225                | 10000                     | 7000                       | 180                          | 243                     | 297                  | 455                                 | 100             | 1400                         |
| V10H230P                | P10H230  | 10                  | 230                    | 300                | 3500                      | 3000                       | 60                           | 324                     | 396                  | 595                                 | 25              | 250                          |
| V14H230P                | P14H230  | 14                  | 230                    | 300                | 6500                      | 5000                       | 105                          | 324                     | 396                  | 595                                 | 50              | 550                          |
| V20H230P                | P20H230  | 20                  | 230                    | 300                | 10000                     | 7000                       | 225                          | 324                     | 396                  | 595                                 | 100             | 1100                         |
| V10H250P                | P10H250  | 10                  | 250                    | 320                | 3500                      | 3000                       | 65                           | 351                     | 429                  | 650                                 | 25              | 220                          |
| V14H250P                | P14H250  | 14                  | 250                    | 320                | 6500                      | 5000                       | 115                          | 351                     | 429                  | 650                                 | 50              | 500                          |
| V20H250P                | P20H250  | 20                  | 250                    | 320                | 10000                     | 7000                       | 240                          | 351                     | 429                  | 650                                 | 100             | 1000                         |
| V10H275P                | P10H275  | 10                  | 275                    | 350                | 3500                      | 3000                       | 70                           | 387                     | 473                  | 710                                 | 25              | 200                          |
| V14H275P                | P14H275  | 14                  | 275                    | 350                | 6500                      | 5000                       | 130                          | 387                     | 473                  | 710                                 | 50              | 450                          |
| V20H275P                | P20H275  | 20                  | 275                    | 350                | 10000                     | 7000                       | 260                          | 387                     | 473                  | 710                                 | 100             | 900                          |
| V10H300P                | P10H300  | 10                  | 300                    | 385                | 3500                      | 3000                       | 75                           | 423                     | 517                  | 775                                 | 25              | 180                          |
| V14H300P                | P14H300  | 14                  | 300                    | 385                | 6500                      | 5000                       | 140                          | 423                     | 517                  | 775                                 | 50              | 400                          |
| V20H300P                | P20H300  | 20                  | 300                    | 385                | 10000                     | 7000                       | 290                          | 423                     | 517                  | 775                                 | 100             | 800                          |
| V10H320P                | P10H320  | 10                  | 320                    | 420                | 3500                      | 3000                       | 80                           | 459                     | 561                  | 840                                 | 25              | 170                          |
| V14H320P                | P14H320  | 14                  | 320                    | 420                | 6500                      | 5000                       | 150                          | 459                     | 561                  | 840                                 | 50              | 380                          |
| V20H320P                | P20H320  | 20                  | 320                    | 420                | 10000                     | 7000                       | 320                          | 459                     | 561                  | 840                                 | 100             | 750                          |
| V10H385P                | P10H385  | 10                  | 385                    | 505                | 3500                      | 3000                       | 85                           | 558                     | 682                  | 1025                                | 25              | 160                          |
| V14H385P                | P14H385  | 14                  | 385                    | 505                | 6500                      | 5000                       | 175                          | 558                     | 682                  | 1025                                | 50              | 360                          |
| V20H385P                | P20H385  | 20                  | 385                    | 505                | 10000                     | 7000                       | 325                          | 558                     | 682                  | 1025                                | 100             | 700                          |
| V10H420P                | P10H420  | 10                  | 420                    | 560                | 3500                      | 3000                       | 90                           | 612                     | 748                  | 1120                                | 25              | 140                          |
| V14H420P                | P14H420  | 14                  | 420                    | 560                | 6500                      | 5000                       | 185                          | 612                     | 748                  | 1120                                | 50              | 300                          |
| V20H420P                | P20H420  | 20                  | 420                    | 560                | 10000                     | 7000                       | 330                          | 612                     | 748                  | 1120                                | 100             | 600                          |
| V10H440P                | P10H440  | 10                  | 440                    | 585                | 3500                      | 3000                       | 95                           | 643.5                   | 786.5                | 1180                                | 25              | 130                          |
| V14H440P                | P14H440  | 14                  | 440                    | 585                | 6500                      | 5000                       | 185                          | 643.5                   | 786.5                | 1180                                | 50              | 260                          |
| V20H440P                | P20H440  | 20                  | 440                    | 585                | 10000                     | 7000                       | 340                          | 643.5                   | 786.5                | 1180                                | 100             | 500                          |
| V10H460P                | P10H460  | 10                  | 460                    | 615                | 3500                      | 3000                       | 95                           | 675                     | 825                  | 1240                                | 25              | 120                          |
| V14H460P                | P14H460  | 14                  | 460                    | 615                | 6500                      | 5000                       | 190                          | 675                     | 825                  | 1240                                | 50              | 220                          |
| V20H460P                | P20H460  | 20                  | 460                    | 615                | 10000                     | 7000                       | 370                          | 675                     | 825                  | 1240                                | 100             | 400                          |
| V10H510P                | P10H510  | 10                  | 510                    | 670                | 3500                      | 3000                       | 98                           | 738                     | 902                  | 1355                                | 25              | 110                          |
| V14H510P                | P14H510  | 14                  | 510                    | 670                | 6500                      | 5000                       | 205                          | 738                     | 902                  | 1355                                | 50              | 200                          |
| V20H510P                | P20H510  | 20                  | 510                    | 670                | 10000                     | 7000                       | 410                          | 738                     | 902                  | 1355                                | 100             | 350                          |
| V10H550P                | P10H550  | 10                  | 550                    | 745                | 3500                      | 3000                       | 98                           | 819                     | 1001                 | 1500                                | 25              | 100                          |
| V14H550P                | P14H550  | 14                  | 550                    | 745                | 6500                      | 5000                       | 210                          | 819                     | 1001                 | 1500                                | 50              | 180                          |
| V20H550P                | P20H550  | 20                  | 550                    | 745                | 10000                     | 7000                       | 450                          | 819                     | 1001                 | 1500                                | 100             | 300                          |
| V10H625P                | P10H625  | 10                  | 625                    | 825                | 3500                      | 3000                       | 110                          | 900                     | 1100                 | 1650                                | 25              | 90                           |
| V14H625P                | P14H625  | 14                  | 625                    | 825                | 6500                      | 5000                       | 235                          | 900                     | 1100                 | 1650                                | 50              | 160                          |
| V20H625P                | P20H625  | 20                  | 625                    | 825                | 10000                     | 7000                       | 490                          | 900                     | 1100                 | 1650                                | 100             | 250                          |

Note: Average power dissipation of transients not to exceed 0.4W, 0.6W or 1W for model sizes 10mm, 14mm, and 20mm respectively.

# HMOV™ Varistor Series

## Radial Led Varistors

### Current Energy and Power Dissipation Ratings

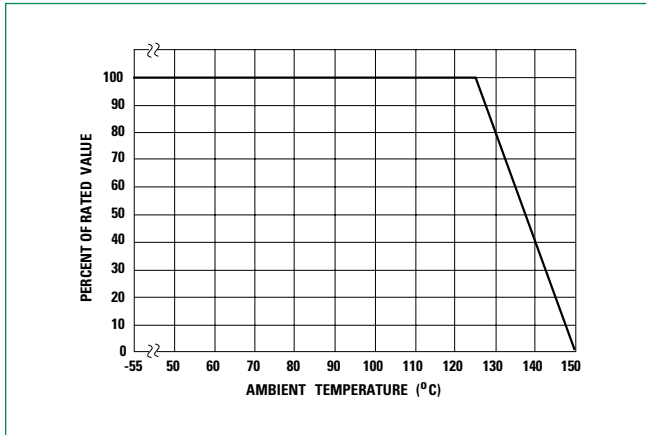

**Note:** The peak surge current and energy ratings must be reduced for applications exceeding 125°C ambient temperature.

### Peak Pulse Current Test Waveform for Clamping Voltage

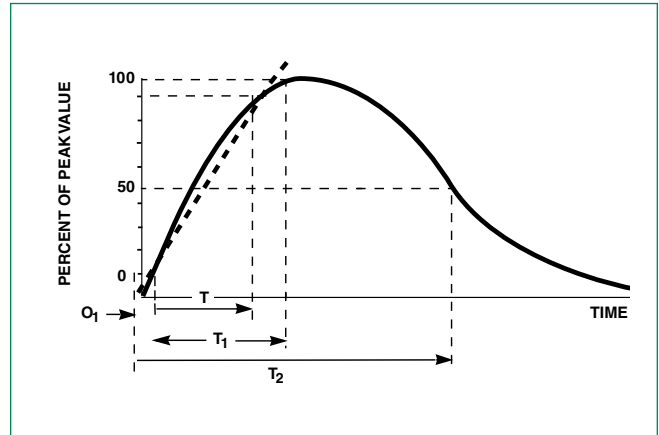

$O_1$  = Virtual Origin of Wave  
 $T$  = Time from 10% to 90% of Peak  
 $T_1$  = Rise Time =  $1.25 \times T$   
 $T_2$  = Decay Time  
**Example** - For an 8/20 $\mu$ s Current Waveform:  
 $8\mu$ s =  $T_1$  = Rise Time  
 $20\mu$ s =  $T_2$  = Decay Time

### Maximum Clamping Voltage for 10mm Parts

V10x11P - V10x40P

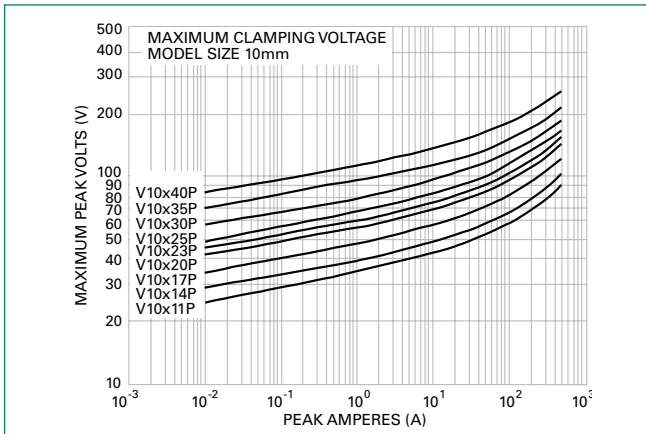

### Maximum Clamping Voltage for 20mm Parts

V20x11P - V20x40P

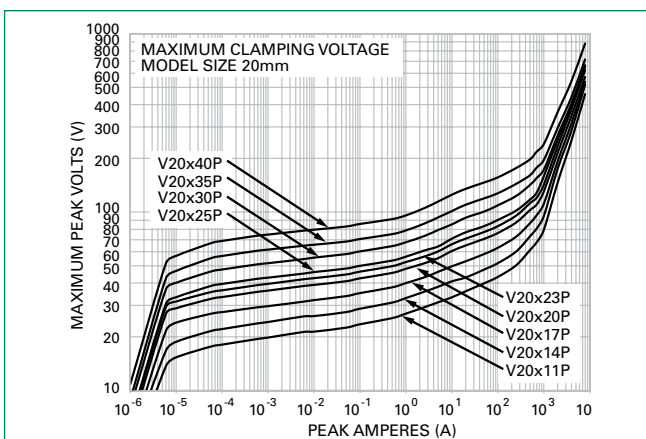

### Maximum Clamping Voltage for 14mm Parts

V14x11P - V14x40P

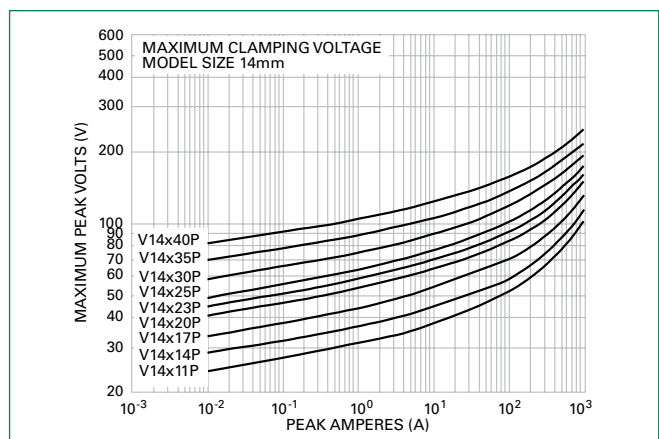

# HMOV™ Varistor Series

## Radial Led Varistors

**Maximum Clamping Voltage for 10mm Parts**  
V10x50P - V10x115P

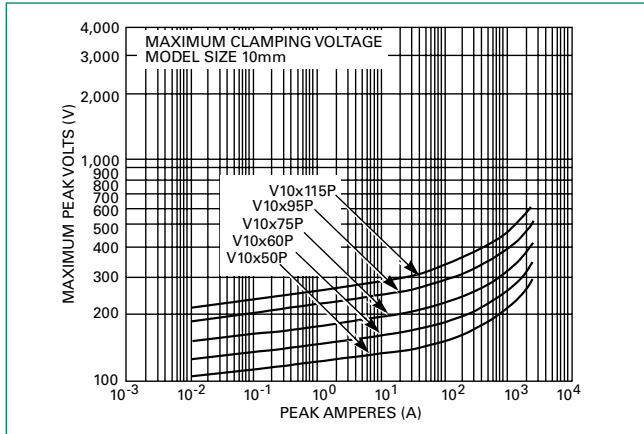

**Maximum Clamping Voltage for 10mm Parts**  
V10x130P - V10x625P

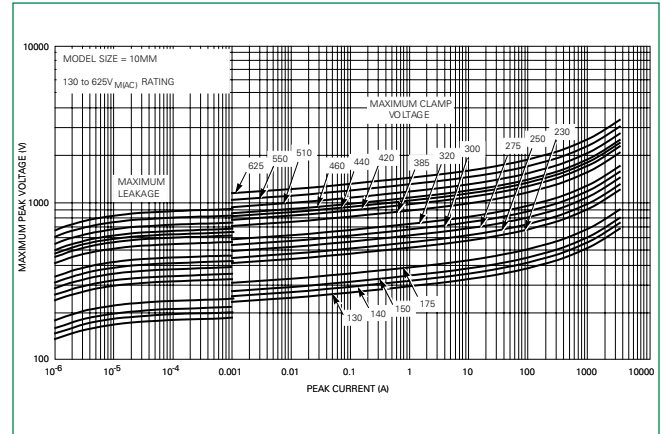

**Maximum Clamping Voltage for 20mm Parts**  
V20x50P - V20x115P

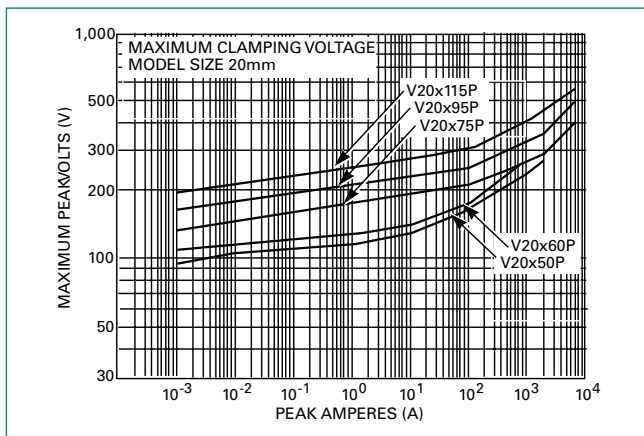

**Maximum Clamping Voltage for 14mm Parts**  
V14x50P - V14x115P

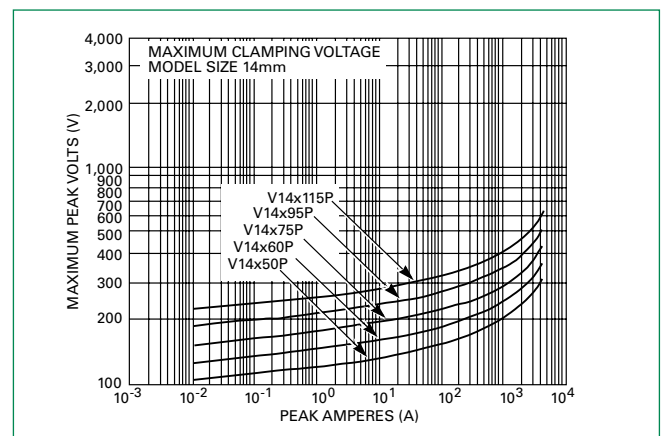

**Maximum Clamping Voltage for 14mm Parts**  
V14x130P - V14x625P

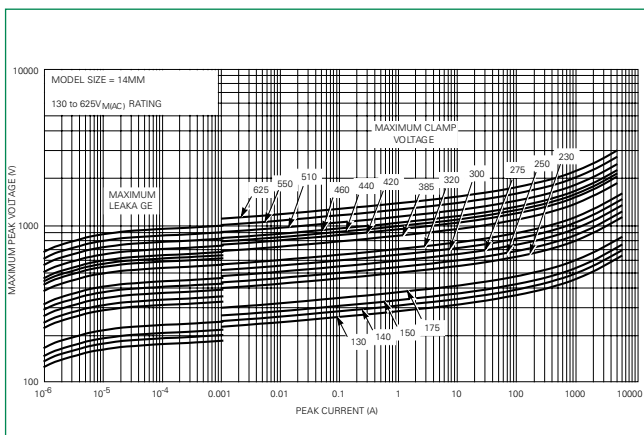

**Maximum Clamping Voltage for 20mm Parts**  
V20x130P - V20x625P

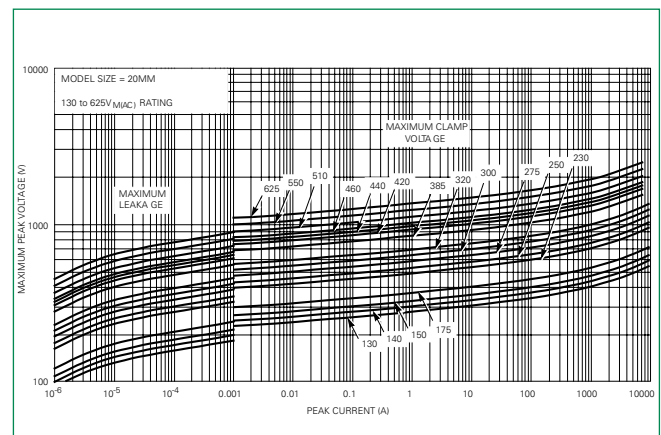

# HMOV™ Varistor Series

## Radial Led Varistors

**Repetitive Surge Capability for 10mm Parts**  
V10x11P - V10x40P

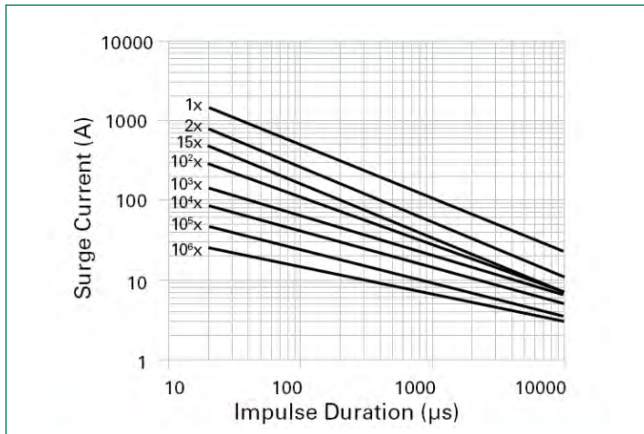

**Repetitive Surge Capability for 14mm Parts**  
V14x11P - V14x40P

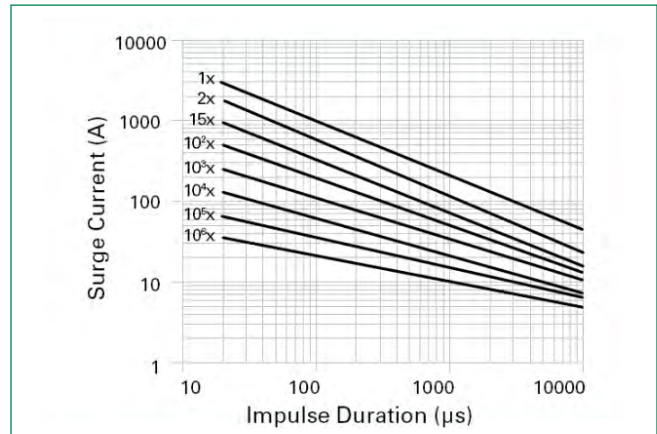

**Repetitive Surge Capability for 20mm Parts**  
V20x11P - V20x40P

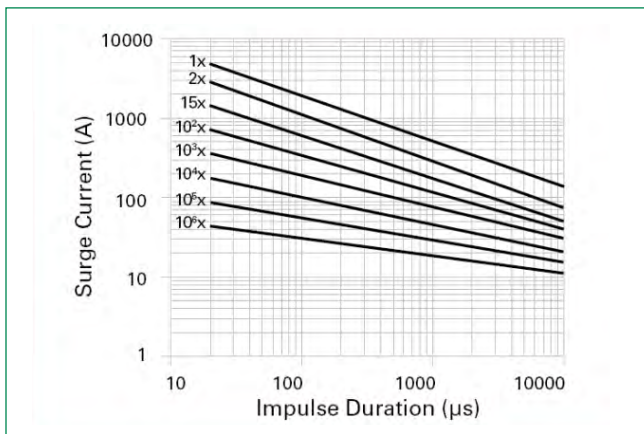

**Maximum Clamping Voltage 10mm Parts**  
V10x115P - V10x625P

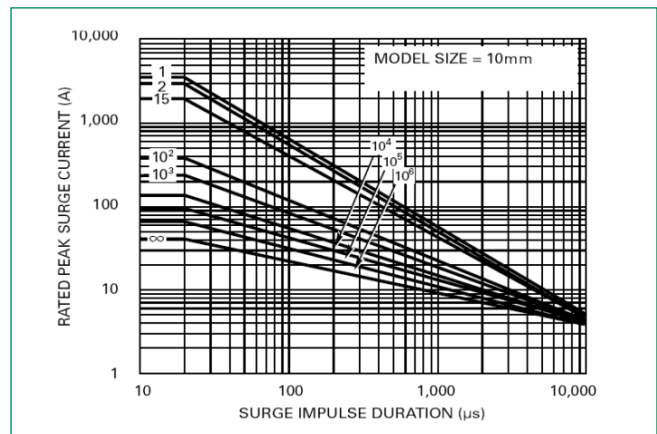

**Note:** Repetitive surge capability is qualified and tested based on 8/20µs current waveform (not combination waveform) and UL1449 40.7.3 (Edition 4) test condition.

**Note:** If pulse ratings are exceeded, a shift of  $V_{\text{NDC}}$  (at specified current) of more than +/-10% could result. This type of shift, which normally results in a decrease of  $V_{\text{NDC}}$ , may result in the device not meeting the original published specifications, but does not prevent the device from continuing to function, and to provide ample protection.

# HMOV™ Varistor Series

## Radial Ledged Varistors

**Repetitive Surge Capability for 10mm Parts**  
V10x50P - V10x95P

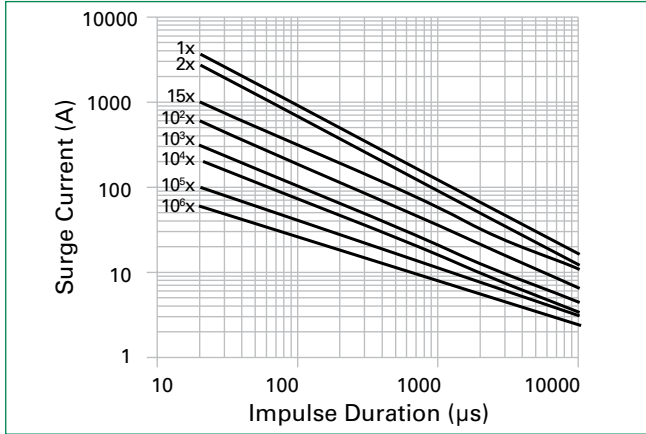

**Repetitive Surge Capability for 14mm Parts**  
V14x50P - V14x95P

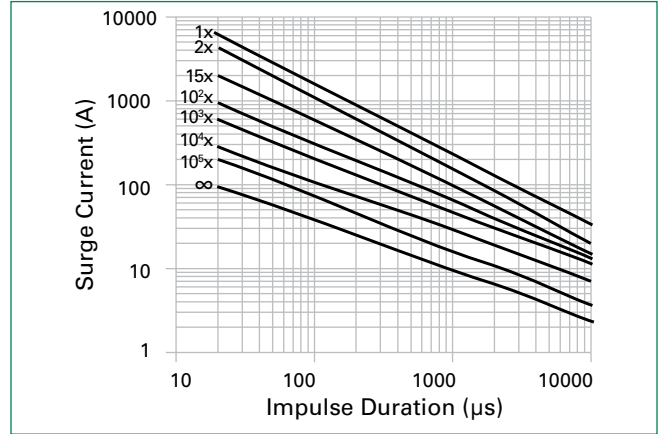

**Repetitive Surge Capability for 20mm Parts**  
V20x50P - V20x95P

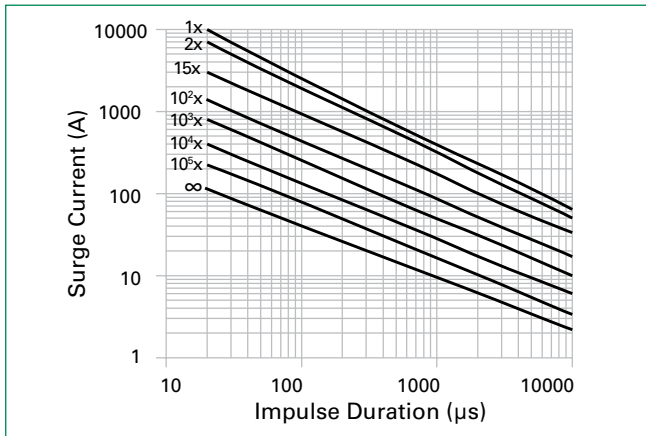

**Repetitive Surge Capability for 14mm Parts**  
V14x115P - V14x625P

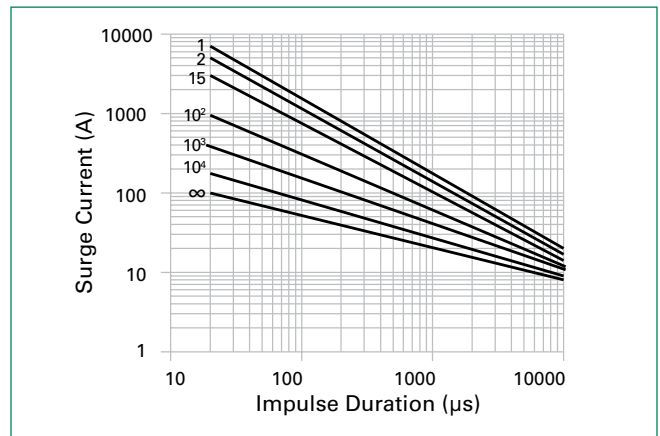

**Note:** Repetitive surge capability is qualified and tested based on 8/20µs current waveform (not combination waveform) and UL1449 40.7.3 (Edition 4) test condition.

**Repetitive Surge Capability for 20mm Parts**  
V20x115P - V20x625P

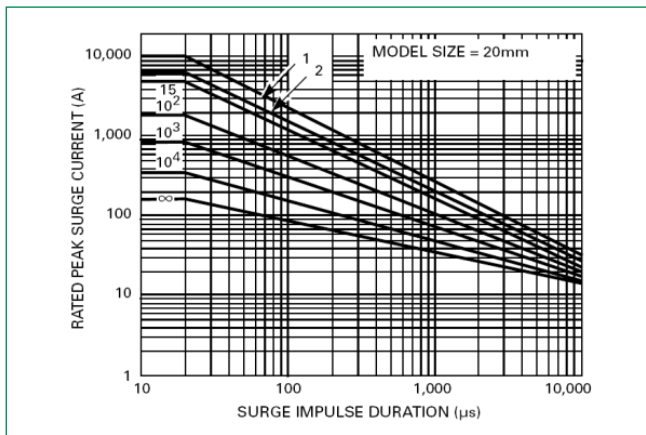

# HMOV™ Varistor Series

## Radial Leaded Varistors

### Wave Solder Profile

**Non Lead-free Profile**

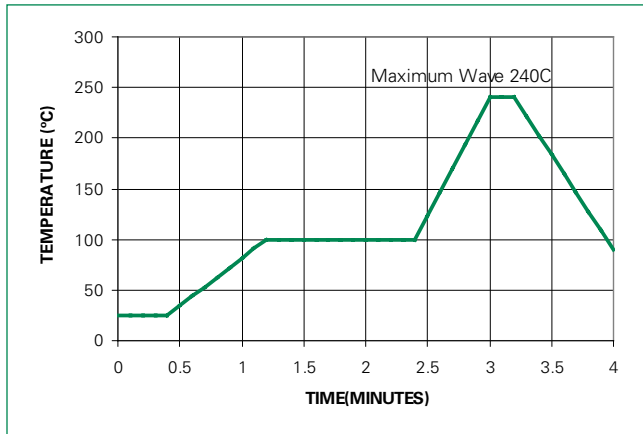

**Lead-free Profile**

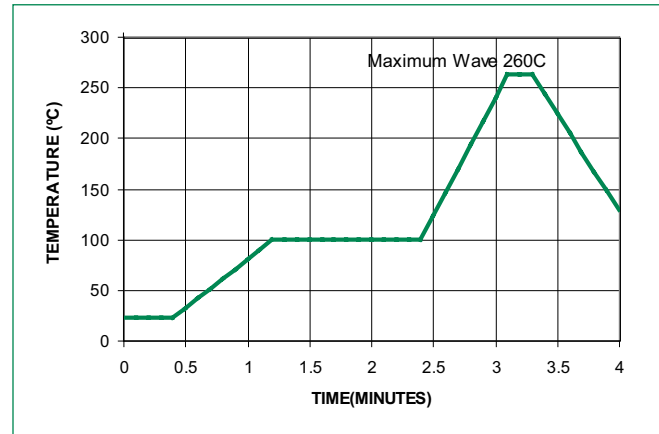

### Physical Specifications

|                                  |  |
|----------------------------------|--|
| <b>Lead Material</b>             | Copper Clad Steel Wire                     |
| <b>Soldering Characteristics</b> | Solderability per MIL-STD-202, Method 208  |
| <b>Insulating Material</b>       | Cured, Silicone meets UL94V-0 requirements |
| <b>Device Labeling</b>           | Marked with LF, voltage and date code      |

### Environmental Specifications

|                             |   |
|-----------------------------|---|
| <b>Humidity Aging</b>       | +85°C, 85% RH, 1500 hours<br>+/-10% typical voltage change    |
| <b>Thermal Shock</b>        | -55°C to +125°C, 1000 cycles<br>+/-10% typical voltage change |
| <b>Solvent Resistance</b>   | MIL-STD-202, Method 215                                       |
| <b>Moisture Sensitivity</b> | Level 1, J-STD-020  |

# HMOV™ Varistor Series

## Radial Leded Varistors

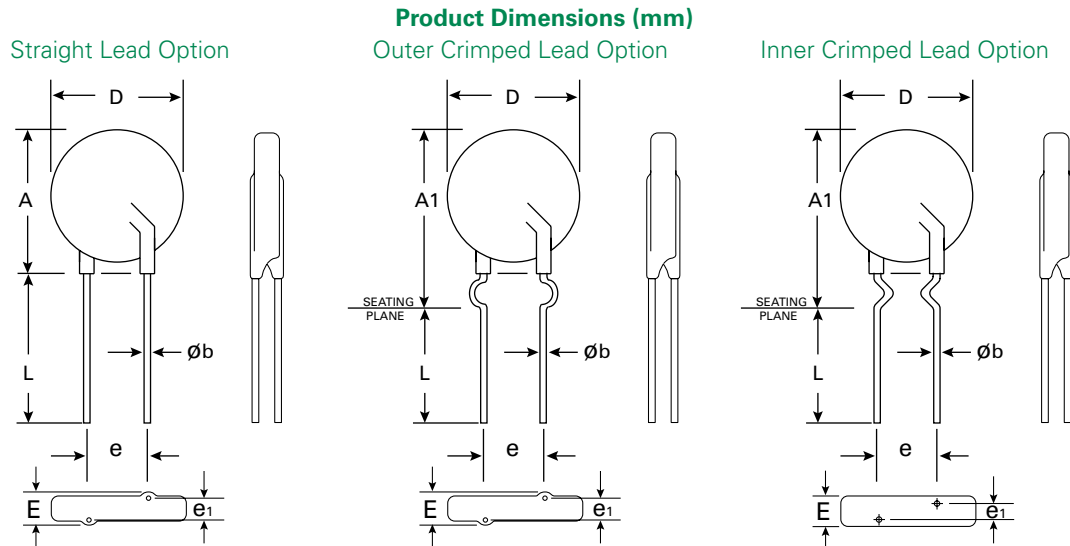

| Dimension               | V <sub>RMS</sub><br>Voltage<br>Model | 10mm Size       |                 | 14mm Size       |                 | 20mm Size       |                 |
|-------------------------|--------------------------------------|-----------------|-----------------|-----------------|-----------------|-----------------|-----------------|
|                         |                                      | Min.<br>mm (in) | Max.<br>mm (in) | Min.<br>mm (in) | Max.<br>mm (in) | Min.<br>mm (in) | Max.<br>mm (in) |
| A                       | 11 - 320                             | -               | 16<br>(0.630)   | -               | 20<br>(0.787)   | -               | 26.5<br>(1.043) |
|                         | 385 - 625                            | -               | 17<br>(0.689)   | -               | 20.5<br>(0.807) | -               | 28.0<br>(1.102) |
| A1                      | All                                  | -               | 19.5<br>(0.768) | -               | 22.5<br>(0.886) | -               | 29.0<br>(1.142) |
| D                       | All                                  | -               | 12.5<br>(0.492) | -               | 17<br>(0.669)   | -               | 23.0<br>(0.906) |
| e                       | 11 - 95                              | 6.5<br>(0.256)  | 8.5<br>(0.335)  | 6.5<br>(0.256)  | 8.5<br>(0.335)  | 6.5<br>(0.256)  | 8.5<br>(0.335)  |
|                         | ≥115                                 |                 |                 |                 |                 | 9.0<br>(0.354)  | 11.0<br>(0.433) |
| e <sub>1</sub>          | 11 - 30                              | 1.0<br>(0.039)  | 3.0<br>(0.118)  | 1.0<br>(0.039)  | 3.0<br>(0.118)  | 1.0<br>(0.039)  | 3.0<br>(0.118)  |
|                         | 35 - 320                             | 1.5<br>(0.059)  | 3.5<br>(0.138)  | 1.5<br>(0.059)  | 3.5 (0.138)     | 1.5<br>(0.059)  | 3.5<br>(0.138)  |
|                         | 385 - 625                            | 2.5<br>(0.098)  | 5.5<br>(0.217)  | 2.5<br>(0.098)  | 5.5<br>(0.217)  | 2.5<br>(0.098)  | 5.5<br>(0.217)  |
| E                       | 11 - 30                              | -               | 5.0<br>(0.197)  | -               | 5.0<br>(0.197)  | -               | 5.0<br>(0.197)  |
|                         | 35 - 320                             | -               | 5.6<br>(0.220)  | -               | 5.6<br>(0.220)  | -               | 5.6<br>(0.220)  |
|                         | 385 - 510                            | -               | 7.3 (0.287)     | -               | 7.3 (0.287)     | -               | 7.3<br>(0.287)  |
|                         | 550 - 625                            | -               | 8.3<br>(0.327)  | -               | 8.3<br>(0.327)  | -               | 8.3<br>(0.327)  |
| Øb                      | All                                  | 0.76<br>(0.030) | 0.86<br>(0.034) | 0.76<br>(0.030) | 0.86<br>(0.034) | 0.76<br>(0.030) | 0.86<br>(0.034) |
| L (bulk packaging only) | All                                  | 25.4<br>(1.00)  | -               | 25.4<br>(1.00)  | -               | 25.4<br>(1.00)  | -               |
| L <sub>TRIM</sub>       | All                                  | 2.5<br>(0.098)  | 4.5<br>(0.177)  | 2.5<br>(0.098)  | 4.5<br>(0.177)  | 2.5<br>(0.098)  | 4.5<br>(0.177)  |

Note: Dimensions in Millimetres (Inches) are typical.

# HMOV™ Varistor Series

## Radial Leded Varistors

### Tape and Reel Specifications

10, 14, and 20mm Devices

Straight Leads "L1"

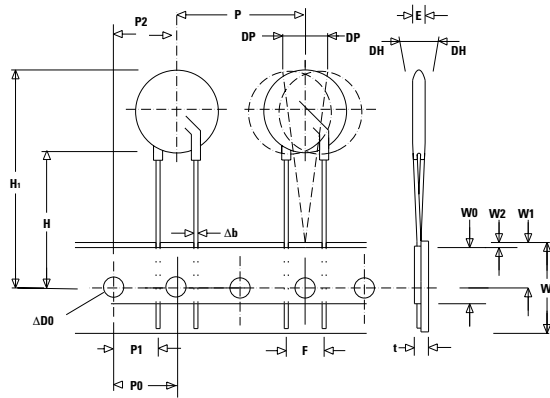

Crimped Leads "L2"

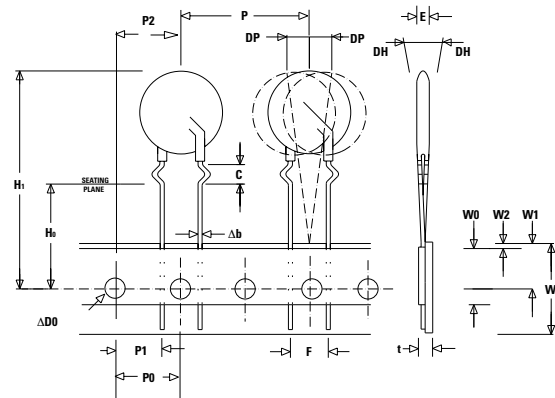

Under Crimped / IN-LINE Leads "L3"

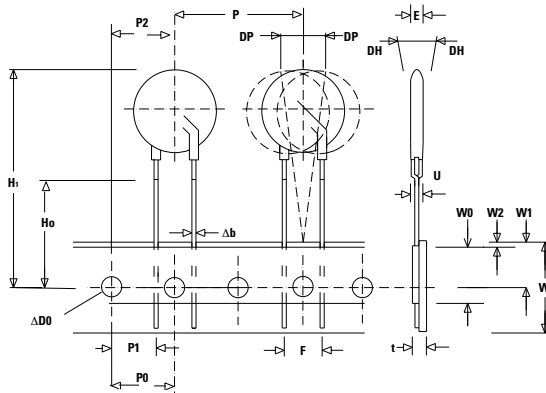

Refer next page for dimension measurement specifications.

# HMOV™ Varistor Series

## Radial Leded Varistors

### Tape and Reel Specifications (continued)

| Symbol               | Description                               | 10mm              | 14mm              | 20mm                     |                   |
|----------------------|---|-------------------|-------------------|--------------------------|-------------------|
|                      |   |                   |                   | (11vac To 95vac Voltage) | (≥115vac Voltage) |
| <b>P</b>             | Pitch of Component                        | 25.4 +/- 1.0      | 25.4 +/- 1.0      | 25.4 +/- 1.0             | 25.4 +/- 1.0      |
| <b>P<sub>0</sub></b> | Feed Hole Pitch                           | 12.7 +/- 0.2      | 12.7 +/- 0.2      | 12.7 +/- 0.2             | 12.7 +/- 0.2      |
| <b>P<sub>1</sub></b> | Feed Hole Center to Pitch                 | 8.85 +/- 0.7      | 8.85 +/- 0.7      | 8.85 +/- 0.7             | 7.70 +/- 0.7      |
| <b>P<sub>2</sub></b> | Hole Center to Component Center           | 12.7 +/- 0.7      | 12.7 +/- 0.7      | 12.7 +/- 0.7             | 12.7 +/- 0.7      |
| <b>F</b>             | Lead to Lead Distance                     | 7.5 +/- 1.0       | 7.5 +/- 1.0       | 7.5 +/- 1.0              | 10 +/- 1.0        |
| <b>h</b>             | Component Alignment                       | 2.0 Max           | 2.0 Max           | 2.0 Max                  | 2.0 Max           |
| <b>W</b>             | Tape Width                                | 18.0 +1.0 / -0.5  | 18.0 +1.0 / -0.5  | 18.0 +1.0 / -0.5         | 18.0 +1.0 / -0.5  |
| <b>W<sub>0</sub></b> | Hold Down Tape Width                      | 12.0 +/- 0.3      | 12.0 +/- 0.3      | 12.0 +/- 0.3             | 12.0 +/- 0.3      |
| <b>W<sub>1</sub></b> | Hole Position                             | 9.0 +0.75 / -0.50 | 9.0 +0.75 / -0.50 | 9.0 +0.75 / -0.50        | 9.0 +0.75 / -0.50 |
| <b>W<sub>2</sub></b> | Hold Down Tape Position                   | 0.5 Max           | 0.5 Max           | 0.5 Max                  | 0.5 Max           |
| <b>H</b>             | Height from Tape Center to Component Base | 18.0 +2.0 / -0.0  | 18.0 +2.0 / -0.0  | 18.0 +2.0 / -0.0         | 18.0 +2.0 / -0.0  |
| <b>H<sub>0</sub></b> | Seating Plane Height                      | 16.0 +/- 0.5      | 16.0 +/- 0.5      | 16.0 +/- 0.5             | 16.0 +/- 0.5      |
| <b>H<sub>1</sub></b> | Component Height                          | 36.0 Max          | 40.0 Max          | 46.5 Max                 | 46.5 Max          |
| <b>D<sub>0</sub></b> | Feed Hole Diameter                        | 4.0 +/- 0.2       | 4.0 +/- 0.2       | 4.0 +/- 0.2              | 4.0 +/- 0.2       |
| <b>t</b>             | Total Tape Thickness                      | 0.7 +/- 0.2       | 0.7 +/- 0.2       | 0.7 +/- 0.2              | 0.7 +/- 0.2       |
| <b>U</b>             | Undercrimp Width                          | 8.0 Max           | 8.0 Max           | 8.0 Max                  | 8.0 Max           |
| <b>p</b>             | Component Alignment                       | 3° Max            | 3° Max            | 3° Max                   | 3° Max            |

- Notes:**
- Radial devices on tape are supplied with crimped leads, straight leads, or under-crimped leads
  - Leads are offset by product dimension e1
  - Conforms to ANSI and EIA specifications
  - Can be supplied to IEC Publication 286-2

### Part Numbering System

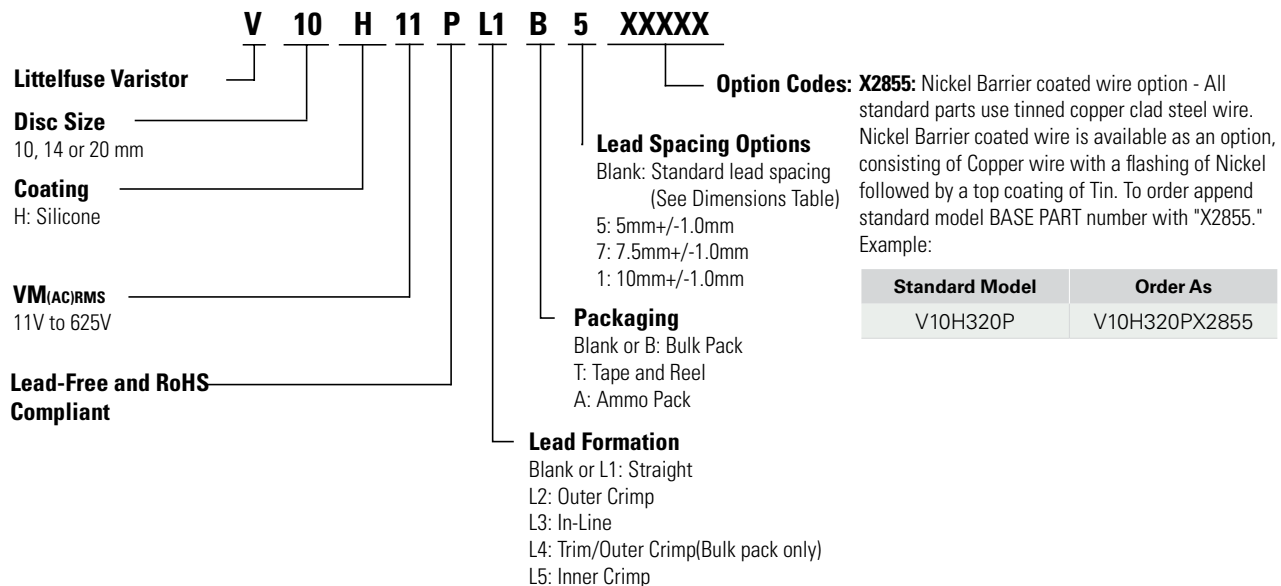

**Disclaimer Notice** - Information furnished is believed to be accurate and reliable. However, users should independently evaluate the suitability of and test each product selected for their own applications. Littelfuse products are not designed for, and may not be used in, all applications. Read complete Disclaimer Notice at [www.littelfuse.com/disclaimer-electronics](http://www.littelfuse.com/disclaimer-electronics).