

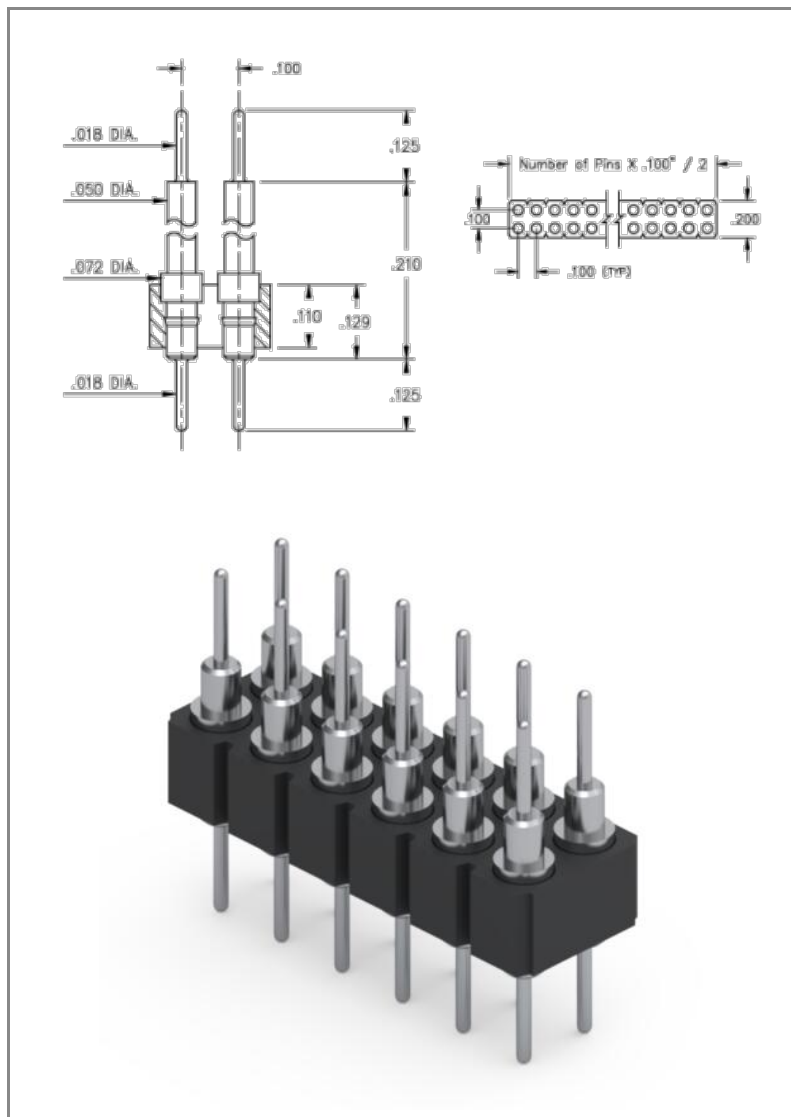

PRODUCT NUMBER: 442-90-212-00-591000

www.mill-max.com
DATA SHEET



| General Info | |
|----------------------------|---|
| Description ¹ : | Board Stacking Pin Header .018" (0,457mm) Pin Head |
| Type: | Interconnect |
| Category: | Machined Pin Header |
| Mounting Style: | Through Hole Solder Mount |
| Tail Type: | Solder Tail |
| # Pins: | 12 |
| Packaging ² : | Packaged in Box or Tube |
| Rows: | Double Row |
| Head Type: | Pin Head |
| ECCN: | Contact Factory |
| HTSUS: | 8536.90.4040 |
| Product Lifecycle: | Active |
| Country Of Origin: | USA |

442-90-212-00-591000- SPECIFICATIONS

| Environmental Specs | |
|-----------------------------------|------------------|
| Temperature Range ³ : | -55/+125° C |
| Moisture Sensitivity Level (MSL): | 1 (Unlimited) |
| REACH Status: | REACH Unaffected |

| Mechanical Specs | |
|------------------|-----------------|
| Mounting Hole: | .022" (0,559mm) |

| Materials | |
|------------------------------------|--|
| Loose Pin/Receptacle # (Material): | 4259 (Brass Alloy) |
| Shell Plating: | 200 μ" Tin/Lead(93/7) over 100 μ" Nickel |
| Inner Plating: | |
| Insulator Material: | High Temp Thermoplastic |

| Technical Specs | |
|-----------------|-----------------|
| Pitch: | .100" (2,540mm) |

| Electrical Specs | |
|----------------------------------|----------------------|
| Current Rating ⁴ : | Application Specific |
| Rated Voltage: | 100 VRMS/150 VDC |
| Insulation Resistance: | 10,000 MΩ min. |
| Dielectric Withstanding Voltage: | 1,000 VRMS min. |

NOTES:

1. Standard Tolerances

Assembly tolerance: +/- .010" (.25mm)

Connector Length "L"

| Connector Length "L" | Tolerance |
|---|---------------------------------------|
| $L \leq 2"$ ($L \leq 50.8$ mm) | +/- .005" (+/- .127 mm) |
| $2 < L \leq 3"$ ($50.8 < L \leq 76.2$ mm) | + .007 / - .006" (+ .178 / - .152 mm) |
| $3 < L \leq 4"$ ($76.2 < L \leq 101.6$ mm) | + .009 / - .007" (+ .229 / - .178 mm) |
| $4 < L \leq 5"$ ($101.6 < L \leq 127$ mm) | + .011 / - .008" (+ .279 / - .203 mm) |
| $5 < L \leq 6.4"$ ($127 < L \leq 162.56$ mm) | + .013 / - .009" (+ .330 / - .229 mm) |

Insulator width: +/- .005 (.13mm)

Insulator height: +/- .005 (.13mm)

Co-planarity of SMT connectors: .005" (.13mm) up to 1" (25.4mm) in connector length

Insulator Flatness: .005" (.13mm) up to 1" (25.4mm) in connector length

Pin Length: +/- .005 (.13mm)

Pin Diameter: +/- .002 (.051mm)

Pin Angle: +/- 2°

2. Not all part numbers in the series may be packaged in tubes. Some specific part numbers may be packaged in a box.
3. Per IEC 60512-11-(4,-9,-10,-12)
4. Current rating is typically a measured function of the female socket/connector. The amount of current a solid, male, brass pin can tolerate is a direct relation of the heat displaced based on current and the ability of neighboring components to handle displaced heat.

ADDITIONAL NOTES AND SPECIFICATIONS

In the interest of improved design, quality and performance, Mill-Max reserves the right to make changes in its specifications without prior notice. Specifications and tolerances are provided wherever possible. The tolerance on dimensions of critical to function features is typically held tighter than the stated standard tolerances, such as press-fits, holes and lengths affecting the coplanarity of SMT products. Due to the wide variety of interconnects Mill-Max offers, the specific tolerances vary from product to product. If you need information regarding the tolerance of a particular part, please contact Technical Services.

RELATED LINKS AND DOCUMENTS

- Engineering Notebook: [Introduction to Machined Pin PCB Connectors & Interconnects](#)
- Environmental Compliance: <https://www.mill-max.com/rohs>