

Surface Mount PTC

OZCN Series

HF Pb OZCN Series – 2016 Chip

RoHS Compliant

Product Features

- 2016 Dimension, Surface mountable, Solid state, Faster time to trip than standard SMD devices.
- Full compliance with EU Directive 2011/65/EU and amending directive 2015/863
- AEC-Q Compliant
- Meets Bel automotive qualification*
 - * - Largely based on internal AEC-Q test plan

Operating (Hold Current) Range

300mA - 2A

Maximum Voltage

6 - 60V (per table)

Temperature Range



-40°C to 85°C

Agency Approval

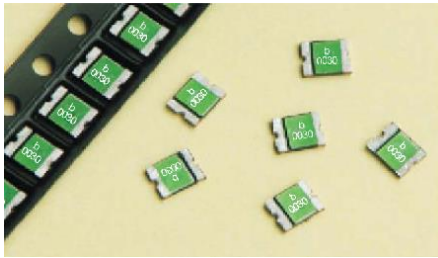

TUV (Std. EN/IEC 60738-1-1 and EN/IEC 60730-1, Cert. R50102117)
UL Recognized Component (Std. UL1434, File E305051)



AEC-Q Compliant

LEAD FREE = 
HALOGEN FREE = 

Electrical Characteristics (23°C)

	Part Number	Hold Current I _H , A	Trip Current I _T , A	Rated Voltage V _{max} , V _{dc}	Maximum Current I _{max} , A	Typical Power P _d , W	Max Time to Trip		Resistance Tolerance		Agency Approvals	
							Current A	Time Sec	R _{min} Ohms	R _{1max} Ohms		
A	0ZCN0030FF2C	0.30	0.60	60	100	1.4	1.5	3.0	0.500	2.300	Y	Y
B	0ZCN0055FF2A	0.55	1.10	60	100	1.4	2.5	5.0	0.200	1.000	Y	Y
C	0ZCN0075FF2A	0.75	1.50	60	100	1.4	8.0	0.5	0.130	0.900	Y	Y
D	0ZCN0110FF2C	1.10	2.20	15	100	1.4	8.0	0.5	0.100	0.400	Y	Y
	0ZCN0110AF2C	1.10	2.20	33	100	1.4	8.0	0.5	0.100	0.400	Y	Y
E	0ZCN0150FF2C	1.50	3.00	15	100	1.4	8.0	0.8	0.070	0.180	Y	Y
F	0ZCN0200FF2C	2.00	4.20	6	100	1.4	8.0	3.0	0.048	0.100	Y	Y

I_H Hold Current- The maximum current at which the device will not trip in still air at 23°C.

I_T Trip current- The minimum current at which the device will trip in still air at 23°C.

V_{max} Maximum voltage device can withstand at its rated current without suffering damage.

I_{max} Maximum fault current device can withstand at rated voltage (V_{max}) without damage.

P_d Typical power dissipated by device when in tripped state in 23°C still air environment.

R_{min} Minimum device resistance at 23°C in initial un-soldered state.

R_{1max} Maximum device resistance at 23°C, 1 hour after initial device trip, or after being soldered to PCB in end application.



Specifications subject to change without notice

belfuse.com/circuit-protection

Please read our datasheet & drawing disclaimer [here](#).

PTC's – Basic Theory of Operation / “Tripped” Resistance Explanation

A Bel PTC consists of a block of polymeric material containing conductive carbon granules which is sandwiched between two conductive metal plates. When this polymer block reaches approximately 125C, either due to current passing through it via conductive chains of carbon particles or due to an external heat source; it swells volumetrically. This expansion breaks apart a majority of the chains of carbon granules that run randomly between the two conductive plates. This behavior results in a sharp increase in resistance across the two plates which all but eliminates current flow through the device, allowing just enough residual current flow to maintain the block's internal temperature at 125C. Once this “tripped” state current is cut off, the polymer brick cools and shrinks to its original size, thereby allowing its broken carbon chains to reestablish themselves and permit the part to return to its low resistance state. Once cooled to room ambient, the PTC will once again exhibit a resistance less than its “R1max” rating.

At currents below the device I_{HOLD} rating, AND at temperatures below 100C, the PTC maintains a resistance value below its R1 MAX rating.

The catalog data for each device specifies a "Typical Power" value. This is the power required to exactly match the heat lost by the tripped device to its ambient surroundings at 23C. By Ohm's Law, power can be stated as: $W = E^2/R$. Thus the approximate resistance of a “Tripped” PTC can be determined by: $R = E^2/W$, where "E" is the voltage appearing across the PTC (usually the supply's open circuit voltage), and "W" is the Typical Power value for the particular PTC.

Since the PPTC acts to maintain a constant internal temperature, its apparent resistance will change based upon applied voltage and, to a lesser degree, ambient conditions. Consider the following example....

A PTC with a Typical Power of 1 watt protecting a circuit using a 60V supply will demonstrate an apparent, tripped resistance "R" of:

$$R = 60^2/1 = 3,600 \text{ ohms}$$

This same tripped device when used to protect a 12V circuit would now present an apparent resistance of:

$$R = 12^2/1 = 144 \text{ ohms}$$

The value for Typical Power is "typical" because any physical factors that affect heat loss (such as ambient temperature or air convection) will somewhat alter the level of power that the PTC needs to maintain its internal temperature. In short, PTCs do not exhibit a constant, quantifiable tripped resistance value.

Average Time Current Characteristic Curve at 23°C

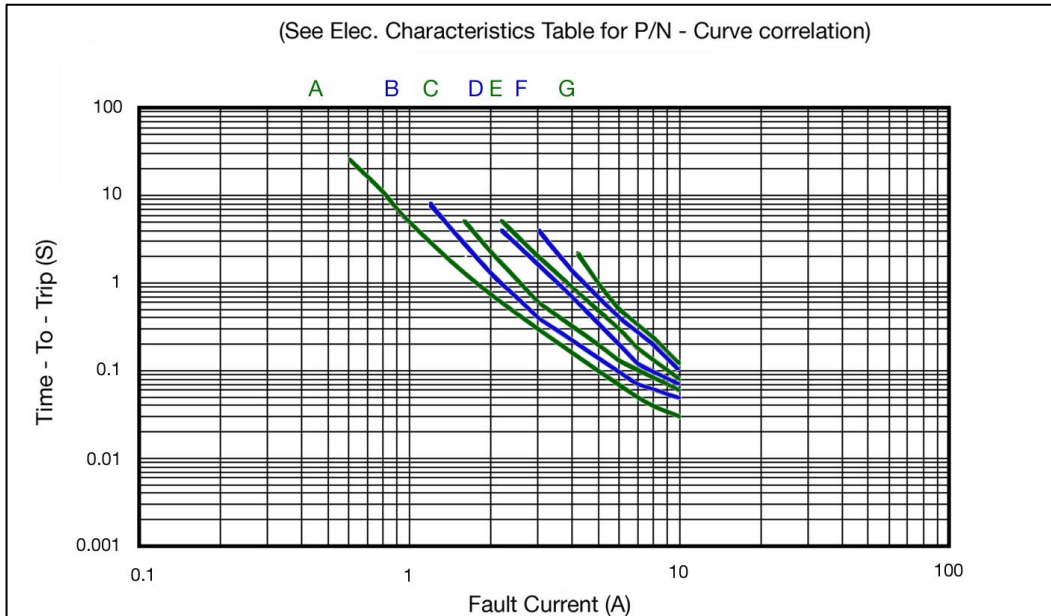

The Average Time Current Characteristic Curve and Temperature Rerating Curve are affected by a number of variables and these curves are provided for guidance only.



Specifications subject to change without notice

Bel Fuse Inc.
206 Van Vorst Street
Jersey City, NJ 07302 USA

+1 201.432.0463
Bel.US.CS@belf.com
belfuse.com/circuit-protection

Pad Layout

The dimensions in the table below provide the recommended pad layout.

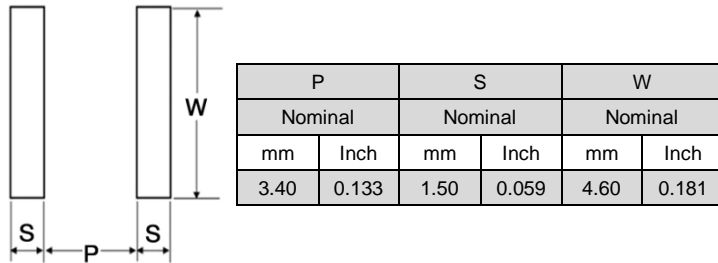

Termination Pad Materials

Matte Tin – Plated Copper

Mechanical Dimensions and Marking

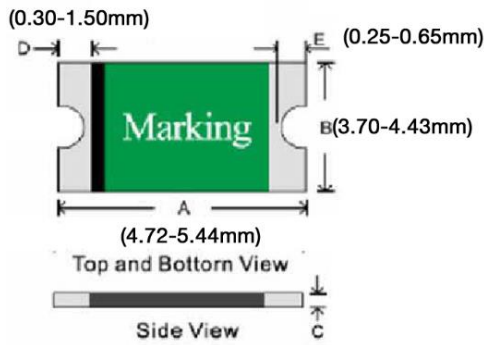

All dimensions in mm.

Part Number	Dimensions		Marking Code	
	C		"b", IH code	
	Min	Max		
0ZCN0030FF2C	0.40	1.15	0030	
0ZCN0055FF2A	0.40	1.70	0055	
0ZCN0075FF2A	0.40	1.70	0075	
0ZCN0110FF2C	0.30	0.70	0110	
0ZCN0110AF2C	0.30	0.70		110 33
0ZCN0150FF2C	0.25	0.65	0150	
0ZCN0200FF2C	0.25	0.65	0200	

Temperature Derating Table

I Hold Value	Temperature Derating									
	-40	-20	0	23	30	40	50	60	70	85
0030 and 0050	167%	150%	133%	100%	93%	83%	73%	63%	51%	33%
0075 thru 0200	143%	129%	116%	100%	94%	86%	77%	69%	61%	48%

Thermal Derating Curve

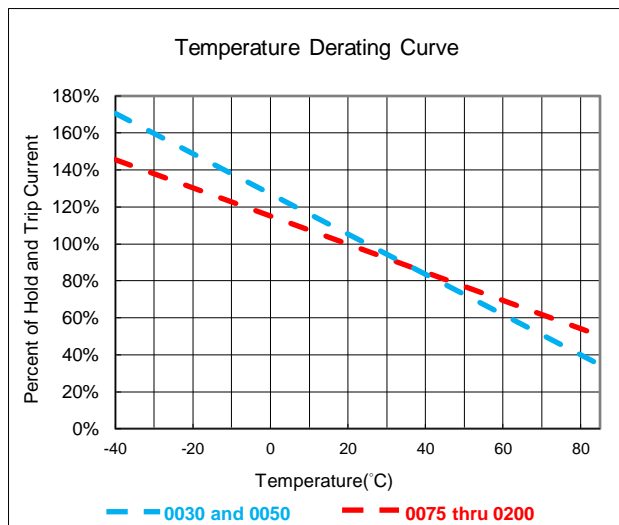

Cautionary Notes

1. Operation beyond the specified maximum ratings or improper use may result in damage and possible electrical arcing and/or flame.
2. These Polymer PTC (PPTC) devices are intended for protection against occasional overcurrent/overtemperature fault conditions and may not be suitable for use in applications where repeated and/or prolonged fault conditions are anticipated.
3. Avoid contact of PTC device with chemical solvent. Prolonged contact may adversely impact the PTC performance.
4. These PTC devices may not be suitable for use in circuits with a large inductance, as the PTC trip can generate circuit voltage spikes above the PTC rated voltage.
5. These devices may be used in both DC and AC circuits provided that peak-to-peak line voltage when carrying AC does not exceed the PTC's Vmax rating. As PTCs are essentially thermal devices, the RMS value of AC current carried by a PTC will produce tripping parameters and times-to-trip similar to those of a DC voltage of the same magnitude.
6. If potting is mandated, avoid rigid potting compounds as they will encase the PTC and prevent it from volumetrically expanding to properly respond to a trip event.
7. MSL: 2a (According to IPC J-Std-020).



Specifications subject to change without notice

Bel Fuse Inc.
206 Van Vorst Street
Jersey City, NJ 07302 USA

+1 201.432.0463
Bel.US.CS@belf.com
belfuse.com/circuit-protection

Environmental Specifications

Temperature cycling	JESD22 Method JA-104
Biased humidity	MIL-STD-202 Method 103
Operational life	MIL-STD-202 Method 108
Resistance to solvents	MIL-STD-202 Method 215
Mechanical shock	MIL-STD-202 Method 213
Vibration	MIL-STD-202 Method 204
Resistance to soldering heat	MIL-STD-202 Method 210
Thermal shock	MIL-STD-202 Method 107
Solderability	ANSI/J-STD-002
Board flex(SMD)	AEC-Q200-005
Terminal strength	AEC-Q200-006

Solder Reflow and Rework Recommendations

Profile Feature	Pb-Free Assembly
Average Ramp-Up Rate (T _{smax} to T _p)	3°C/second max
Preheat :	
Temperature Min (T _{smin})	150°C
Temperature Max (T _{smax})	200°C
Time (t _{smin} to t _{smax})	60-180 seconds
Time maintained above:	
Temperature(TL)	217°C
Time (tL)	60-150 seconds
Peak/Classification Temperature(T _p) :	260°C
Time within 5°C of actual Peak :	
Temperature (t _p)	20-40 seconds
Ramp-Down Rate :	6°C/second max.
Time 25°C to Peak Temperature :	8 minutes max

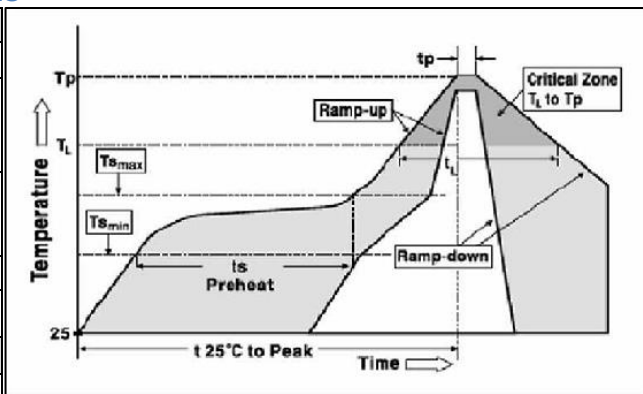

Solder Reflow

Due to "lead free / RoHS Compliant" construction of these PTC devices, the required Temperature and Dwell Time in the "Soldering" zone of the reflow profile are greater than those used for non-RoHS devices.

1. Recommended reflow methods; IR, vapor phase oven, hot air oven.
2. Not Recommended For Wave Solder / Direct Immersion.
3. Recommended paste thickness range – 0.20 – 0.25mm.
4. Devices are compatible with standard industry cleaning solvents and methods.
5. MSL: 2a (According to IPC J-Std-020).

Caution

If reflow temperature / dwell times exceed the recommended profile, the electrical performance of the PTC may be affected.

Rework: MIL-STD-202G Method 210F, Test Condition A.

Standard Packaging

Part Number	Tape/Reel Qty
0ZCN0030FF2C	2,000
0ZCN0055FF2A	1,000
0ZCN0075FF2A	1,000
0ZCN0110FF2C Thru 0ZCN0200FF2C	2,000

2000 or 1000 fuses in 7 inches dia. Reel, 8mm wide tape, 4mm pitch, per EIA-481(equivalent IEC-286 part 3).

P/N Explanation and Ordering Information

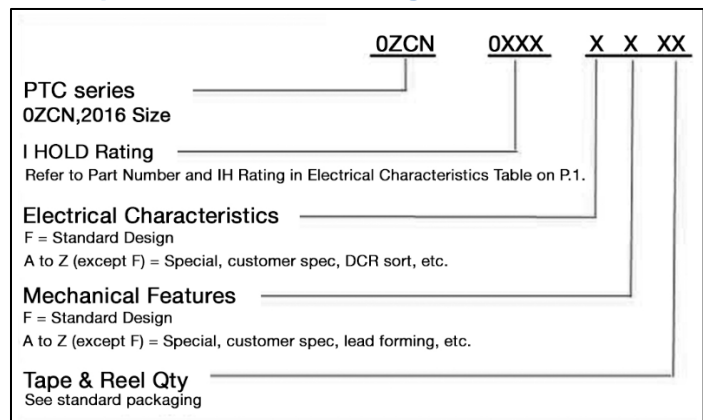

Specifications subject to change without notice

Bel Fuse Inc.
206 Van Vorst Street
Jersey City, NJ 07302 USA

+1 201.432.0463
Bel.US.CS@belf.com
belfuse.com/circuit-protection