

Data Sheet | Item Number: 255-412/000-009/999-950

PCB terminal block; push-button; 2.5 mm²; Pin spacing 5/5.08 mm; 12-pole; suitable for Ex-e applications; CAGE CLAMP®; commoning option; 2,50 mm²; light gray

<https://www.wago.com/255-412/000-009/999-950>

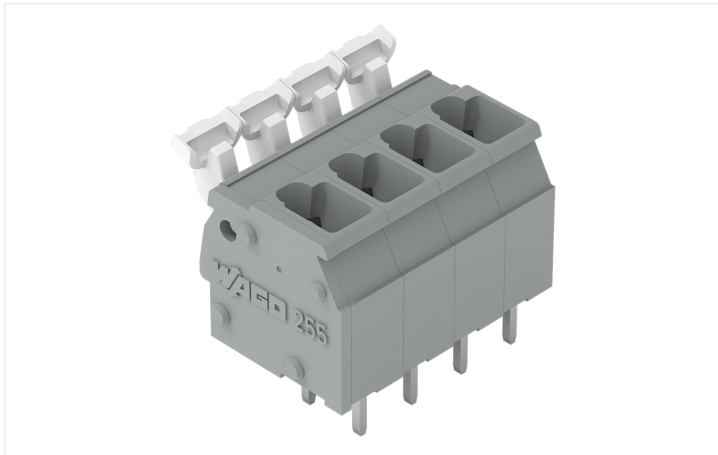

Color: ■ light gray

Similar to illustration

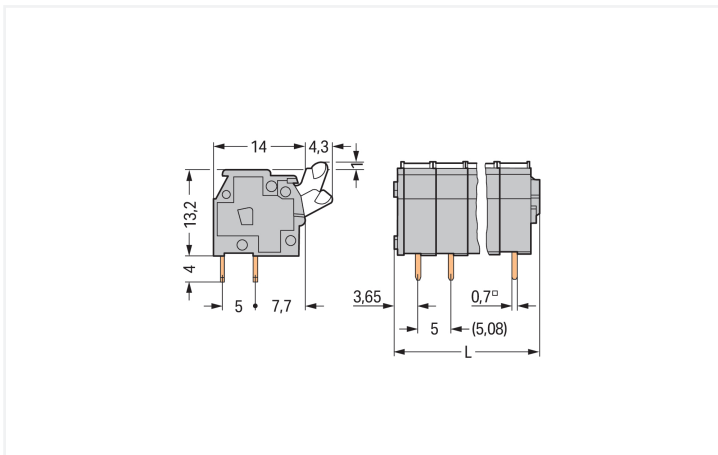
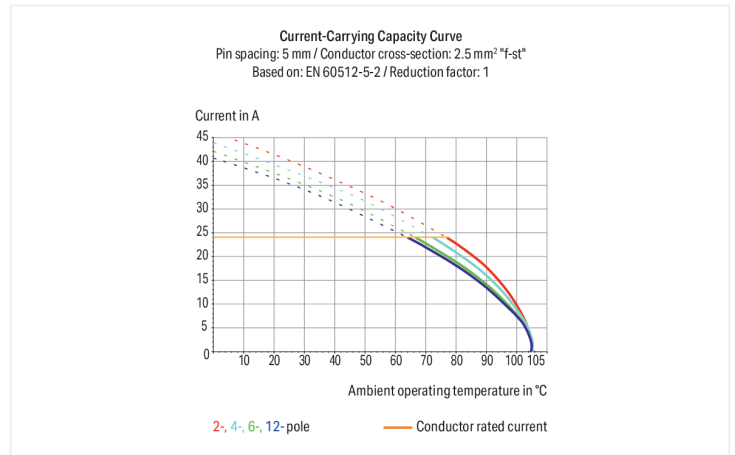

Dimensions in mm

L = (pole no. x pin spacing) + 2.9 mm

PCB terminal block, 255 Series, solder pin dimensions 0.7 x 0.7 mm

This PCB terminal block (item number 255-412/000-009/999-950) is designed for quick and easy connections. It is a universal connector that can be used almost anywhere, for example, as a pluggable PCB connector, panel feedthrough header, connector for rail-mount terminal blocks, or a floating connector for different mounting methods. Conductors can only be connected to this PCB terminal block if their strip length is between 5 and 6 mm. This product features one conductor terminal and utilizes CAGE CLAMP®. Our CAGE CLAMP® connection offers a safe and maintenance-free way to connect all types of conductors. You do not need to prepare the conductor in any way, such as crimping ferrules. The dimensions are (62.9 x 18.2 x 18.3) mm (width x height x depth). Depending on the type of conductor, this PCB terminal block is ideal for conductor cross sections ranging from 0.08 mm² to 2.5 mm².

The contact surface is coated with tin. This PCB terminal block is operated with a push-button. THT is used to assemble the PCB terminal block. Insert the conductor at an angle of 90°.

Electrical data

Ex information

Ratings per	ATEX: PTB 06 ATEX 1061 U / IECEx: PTB 06.0042 U
Rated voltage EN (Ex e II)	176 V
Rated current (Ex e II)	16 A

Connection Data

Clamping units	12
Total number of potentials	12
Number of connection types	1
Number of levels	1

Connection 1

Connection technology	CAGE CLAMP®
Actuation type	Push-button
Solid conductor	0.08 ... 2.5 mm ² / 28 ... 12 AWG
Fine-stranded conductor	0.08 ... 2.5 mm ² / 28 ... 12 AWG
Fine-stranded conductor; with insulated ferrule	0.25 ... 1.5 mm ²
Fine-stranded conductor; with uninsulated ferrule	0.25 ... 1.5 mm ²
Note (conductor cross-section)	12 AWG: THHN, THWN
Strip length	5 ... 6 mm / 0.2 ... 0.24 inches
Conductor connection direction to PCB	90 °
Pole number	12

Physical data

Pin spacing	5/5.08 mm / 0.197/0.2 inches
Width	62.9 mm / 2.476 inches
Height	18.2 mm / 0.717 inches
Height from the surface	14.2 mm / 0.559 inches
Depth	18.3 mm / 0.72 inches
Solder pin length	4 mm
Solder pin dimensions	0.7 x 0.7 mm
Drilled hole diameter with tolerance	1.1 (+0.1) mm

PCB contact

PCB contact	THT
Solder pin arrangement	over the entire terminal strip (in-line)
Number of solder pins per potential	2

Material data

Note (material data)	Information on material specifications can be found here
Color	light gray
Material group	I
Insulation material (main housing)	Polyamide (PA66)
Flammability class per UL94	V0
Clamping spring material	Chrome-nickel spring steel (CrNi)
Contact material	Electrolytic copper (E _{Cu})
Contact Plating	Tin
Fire load	0.173 MJ
Weight	14.3 g

Environmental requirements

Limit temperature range	-60 ... +105 °C
-------------------------	-----------------

Commercial data

Product Group	4 (Printed Circuit Connectors)
PU (SPU)	60 (15) pcs
Packaging type	Box
Country of origin	CH
GTIN	4044918665636
Customs tariff number	85369010000

Product Classification

UNSPSC	39121409
eCl@ss 10.0	27-44-04-01
eCl@ss 9.0	27-44-04-01
ETIM 9.0	EC002643
ETIM 10.0	EC002643
ECCN	NO US CLASSIFICATION

Environmental Product Compliance

RoHS Compliance Status	Compliant, No Exemption
------------------------	-------------------------

Approvals / Certificates

Declarations of conformity and manufacturer's declarations

Approval	Standard	Certificate Name
ATEX-Attestation of Conformity WAGO GmbH & Co. KG	-	-

Approvals for hazardous areas

Approval	Standard	Certificate Name
AEx UL International Germany GmbH c/o Physikalisch Technische Bundesanstalt	UL 60079	E185892 (AEx eb IIC resp. Ex eb IIC)
CCC CNEX	GB/T 3836.3	2020312313000274 (Ex eb IIC Gb, Ex eb I Mb)
IECEX Physikalisch Technische Bundesanstalt	IEC 60079	IECEX PTB 06.0042U (Ex eb IIC GB or Ex eb I Mb)

Downloads

Environmental Product Compliance

Compliance Search
↓

Documentation

Additional Information			
Technical Section	03.04.2019	pdf 2027.26 KB	↓
Gebrückte Klemmen- leisten für Leiterplatten		pdf 303.71 KB	↓

CAD/CAE-Data

CAD data
↓

CAE data
↓
↓













PCB Design
↓
↓

1 Compatible Products

1.1 Optional Accessories

1.1.1 Ferrule

1.1.1.1 Ferrule

 Item No.: 216-321 Ferrule; Sleeve for 0.25 mm ² / AWG 24; insulated; electro-tin plated; yellow	 Item No.: 216-151 Ferrule; Sleeve for 0.25 mm ² / AWG 24; uninsulated; electro-tin plated	 Item No.: 216-322 Ferrule; Sleeve for 0.34 mm ² / 22 AWG; insulated; electro-tin plated; light turquoise	 Item No.: 216-152 Ferrule; Sleeve for 0.34 mm ² / AWG 24; uninsulated; electro-tin plated
 Item No.: 216-221 Ferrule; Sleeve for 0.5 mm ² / 20 AWG; insulated; electro-tin plated; white	 Item No.: 216-121 Ferrule; Sleeve for 0.5 mm ² / AWG 22; uninsulated; electro-tin plated; silver-colored	 Item No.: 216-222 Ferrule; Sleeve for 0.75 mm ² / 18 AWG; insulated; electro-tin plated; gray	 Item No.: 216-122 Ferrule; Sleeve for 0.75 mm ² / AWG 20; uninsulated; electro-tin plated; silver-colored
 Item No.: 216-223 Ferrule; Sleeve for 1 mm ² / AWG 18; insulated; electro-tin plated; red	 Item No.: 216-123 Ferrule; Sleeve for 1 mm ² / AWG 18; uninsulated; electro-tin plated; silver-colored	 Item No.: 216-224 Ferrule; Sleeve for 1.5 mm ² / AWG 16; insulated; electro-tin plated; black	 Item No.: 216-124 Ferrule; Sleeve for 1.5 mm ² / AWG 16; uninsulated; electro-tin plated

1.1.2 Marking

1.1.2.1 Marking strip



Item No.: 210-833

Marking strips; 25 m on roll; 6 mm wide; plain; Self-adhesive; white



Item No.: 210-332/500-202

Marking strips; as a DIN A4 sheet; MARKED; 1-16 (160x); Height of marker strip: 3 mm; Strip length 182 mm; Horizontal marking; Self-adhesive; white



Item No.: 210-332/508-202

Marking strips; as a DIN A4 sheet; MARKED; 1-16 (160x); Height of marker strip: 3 mm; Strip length 182 mm; Horizontal marking; Self-adhesive; white



Item No.: 210-332/500-205

Marking strips; as a DIN A4 sheet; MARKED; 1-32 (80x); Height of marker strip: 3 mm; Strip length 182 mm; Horizontal marking; Self-adhesive; white



Item No.: 210-332/508-205

Marking strips; as a DIN A4 sheet; MARKED; 1-32 (80x); Height of marker strip: 3 mm; Strip length 182 mm; Horizontal marking; Self-adhesive; white



Item No.: 210-332/500-204

Marking strips; as a DIN A4 sheet; MARKED; 17-32 (160x); Height of marker strip: 3 mm; Strip length 182 mm; Horizontal marking; Self-adhesive; white



Item No.: 210-332/508-204

Marking strips; as a DIN A4 sheet; MARKED; 17-32 (160x); Height of marker strip: 3 mm; Strip length 182 mm; Horizontal marking; Self-adhesive; white



Item No.: 210-332/500-206

Marking strips; as a DIN A4 sheet; MARKED; 33-48 (160x); Height of marker strip: 3 mm; Strip length 182 mm; Horizontal marking; Self-adhesive; white



Item No.: 210-332/508-206

Marking strips; as a DIN A4 sheet; MARKED; 33-48 (160x); Height of marker strip: 3 mm; Strip length 182 mm; Horizontal marking; Self-adhesive; white

1.1.3 Test and measurement

1.1.3.1 Testing accessories



Item No.: 249-110

Test plug adapter; suitable for 255, 256, 257 Series PCB terminal blocks; 1-pole; Pin spacing 5 mm / 0.197 in; gray



Item No.: 249-111

Test plug adapter; suitable for 255, 256, 257 Series PCB terminal blocks; 1-pole; Pin spacing 5.08 mm / 0.2 in; orange

1.1.4 Tool

1.1.4.1 Operating tool



Item No.: 210-658

Operating tool; Blade: 3.5 x 0.5 mm; with a partially insulated shaft; angled; short; multicoloured



Item No.: 210-720

Operating tool; Blade: 3.5 x 0.5 mm; with a partially insulated shaft; multicoloured

Installation Notes

Conductor termination



Inserting/removing a conductor – 256 Series.

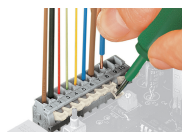

Inserting/removing a conductor (255 Series)

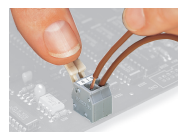

Inserting/removing a conductor via finger-operated lever – 255 Series.

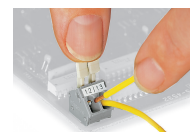

Inserting/removing a conductor via finger-operated lever – 256 Series.

Installation

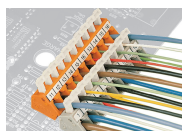

Possible conductor arrangement with terminal strips staggered (for 256 Series only).

Marking



Formation of groups using housings of different colors

Testing

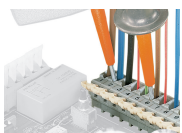

Testing with test probes.



Testing with test plug modules.