

NPN Silicon Phototransistor

OP508FA, OP509A, OP509B



Features:

- Flat lensed for wide acceptance angle (OP508FA)
- Lensed for high sensitivity (OP509)
- Easily stackable on 0.100" (2.54 mm) hole centers
- Inexpensive plastic package
- Mechanically and spectrally matched to OP168F and OP268F series of infrared emitting diodes

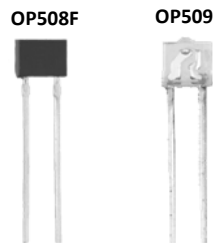

Description:

The **OP508FA** consists of an NPN silicon phototransistor mounted in a flat, black plastic “end-looking” package. The flat sensing surface allows an acceptance half-angle of 60° when measured from the optical axis to the half power point.

Each device in the **OP509** series consists of an NPN silicon phototransistor mounted in a lensed, clear plastic “end-looking” package. The lensing effect of the package allows an acceptance half-angle of 25° when measured from the optical axis to the half power point.

OP508FA and **OP509** series devices can be mounted on 0.100" (2.54 mm) hole centers, which makes them an ideal low-cost alternate to hermetic OP600 sensors. *OP508FA and OP509 series devices are mechanically and spectrally matched to the OP168F and OP268F series of infrared emitting diodes.*

Please refer to Application Bulletin 210 for additional thermal design information.

For custom versions of the **OP508FA** and **OP509** series devices please contact your OPTEK representative.

Applications:

- Applications requiring a wide acceptance angle
- Applications requiring high sensitivity
- Space-limited applications

Ordering Information			
Part Number	Sensor	Viewing Angle	Lead Length
OP508FA	Phototransistor	120°	0.50"
OP509A			
OP509B			



RoHS

General Note

TT Electronics reserves the right to make changes in product specification without notice or liability. All information is subject to TT Electronics' own data and is considered accurate at time of going to print.

© TT electronics plc

TT Electronics | OPTEK Technology
2900 E. Plano Pkwy, Plano, TX 75074 | Ph: +1 972 323 2200
www.ttelectronics.com | sensors@ttelectronics.com

Rev D 08/2025 Page 1

NPN Silicon Phototransistor

OP508FA, OP509A, OP509B



OP508F (A) (Black Plastic Package)

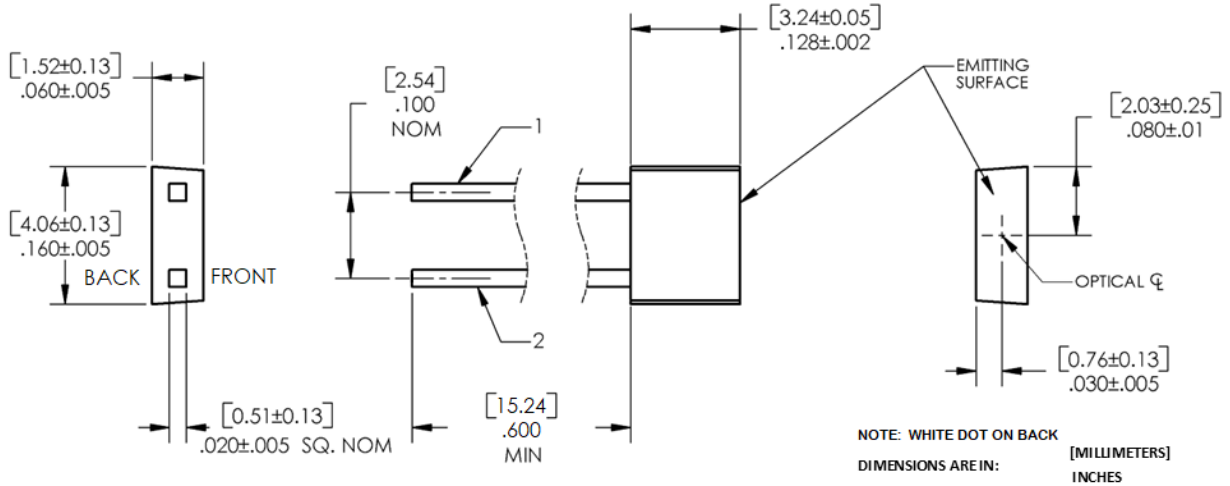

OP509 (A, B) (Lensed Clear Plastic Package)

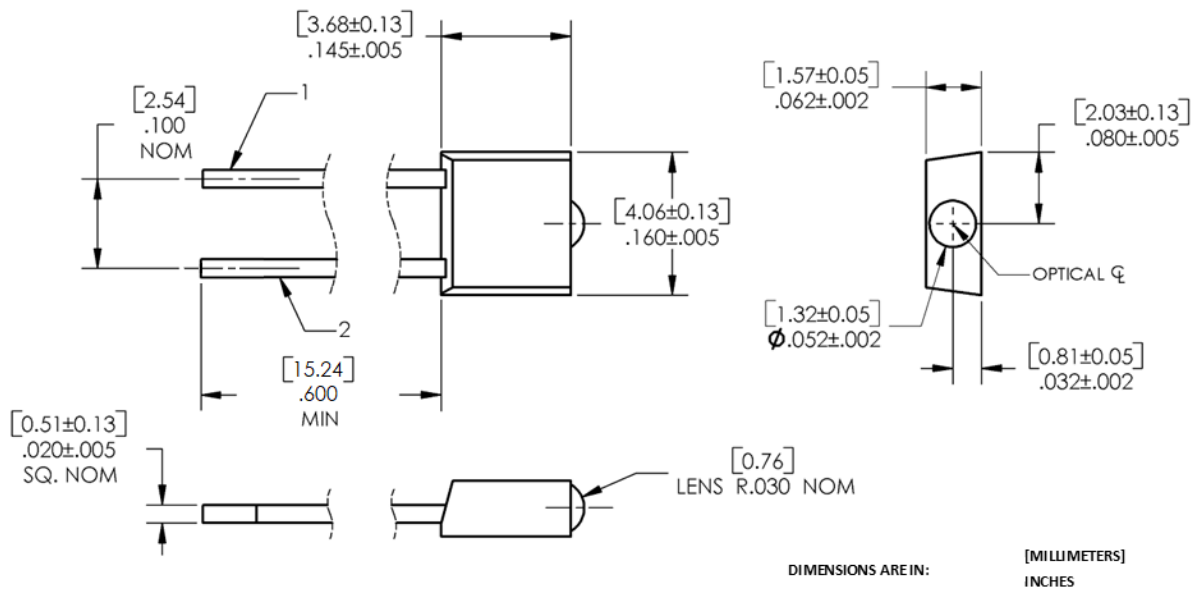

OP508FA & OP509



Pin #	Transistor
1	Collector
2	Emitter

General Note

TT Electronics reserves the right to make changes in product specification without notice or liability. All information is subject to TT Electronics' own data and is considered accurate at time of going to print.

TT Electronics | OPTEK Technology
2900 E. Plano Pkwy, Plano, TX 75074 | Ph: +1 972 323 2200
www.ttelectronics.com | sensors@ttelectronics.com

NPN Silicon Phototransistor

OP508FA, OP509A, OP509B



Electrical Specifications

Absolute Maximum Ratings ($T_A = 25^\circ\text{C}$ unless otherwise noted)

Storage and Operating Temperature Range	-40° C to +100° C
Collector-Emitter Voltage	30 V
Emitter-Collector Voltage	5 V
Lead Soldering Temperature [1/16 inch (1.6 mm) from case for 5 seconds with soldering iron] ⁽¹⁾	260° C
Power Dissipation ⁽²⁾	100 mW

Electrical Characteristics ($T_A = 25^\circ\text{C}$ unless otherwise noted)

SYMBOL	PARAMETER	MIN	TYP	MAX	UNITS	TEST CONDITIONS
$I_{C(ON)}$ ⁽³⁾	On-State Collector Current					
	OP509A (Dome Lens)	5.70	-	20.00	mA	$V_{CE} = 5.0\text{ V}$, $E_E = 5\text{ mW/cm}^2$
	OP508FA (Flat Lens)	2.70	-	-		
	OP509B (Dome Lens)	1.40	-	10.60		
$I_C/\Delta T$ ⁽³⁾	Relative I_C Charge with Temperature	-	1.00	-	%/° C	$V_{CE} = 5.0\text{ V}$, $E_E = 1.0\text{ mW/cm}^2$ $\lambda = 890\text{ nm}$
I_{CEO} ⁽⁴⁾	Collector-Dark Current	-	-	100	nA	$V_{CE} = 10.0\text{ V}$, $E_E = 0$
$V_{(BR)CEO}$	Collector-Emitter Breakdown Voltage	30	-	-	V	$I_C = 1.00\text{ mA}$, $E_E = 0$
$V_{(BR)ECO}$	Emitter-Collector Breakdown Voltage	5	-	-	V	$I_E = 100\ \mu\text{A}$
$V_{CE(SAT)}$	Collector-Emitter Saturation Voltage					
	OP508FA	-	-	0.4	V	$I_C = 300\ \mu\text{A}$, $E_E = 5\text{ mW/cm}^2$
	OP509A & B	-	-	0.4	V	$I_C = 250\ \mu\text{A}$, $E_E = 5\text{ mW/cm}^2$

Notes:

1. RMA flux is recommended. Duration can be extended to 10 seconds maximum when flow soldering. A maximum 20 grams force may be applied to the leads when soldering.
2. Derate linearly 1.07 mW/° C above 25° C.
3. Light source is an unfiltered GaAs or GaAlAs LED with a peak emission wavelength of 935 or 890 nm and a radiometric intensity level which varies less than 10% over the entire lens surface of the phototransistor being tested.
4. To calculate typical collector dark current in μA , use the formula $I_{CEO} = 10^{(0.040 T_A - 3.4)}$, where T_A is ambient temperature in ° C.

General Note

TT Electronics reserves the right to make changes in product specification without notice or liability. All information is subject to TT Electronics' own data and is considered accurate at time of going to print.

TT Electronics | OPTEK Technology
2900 E. Plano Pkwy, Plano, TX 75074 | Ph: +1 972 323 2200
www.ttelectronics.com | sensors@ttelectronics.com

NPN Silicon Phototransistor

OP508FA, OP509A, OP509B



Typical Performance

OP508FA

Typical Spectral Response

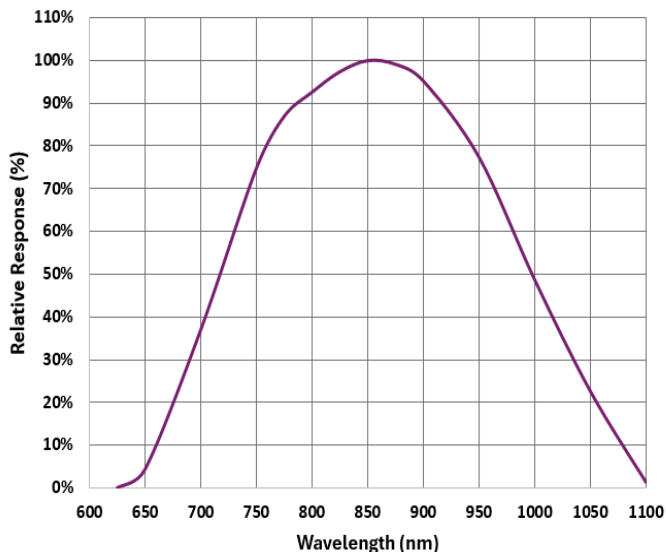

Normalized Collector Current vs Angular Response

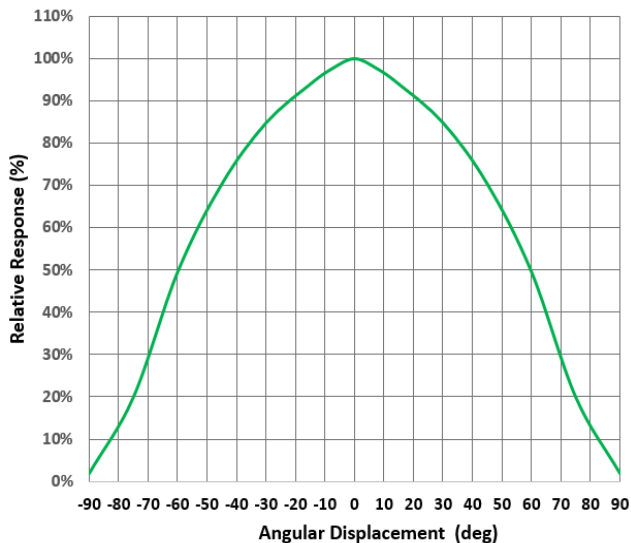

Rise and Fall Times vs Load Resistance

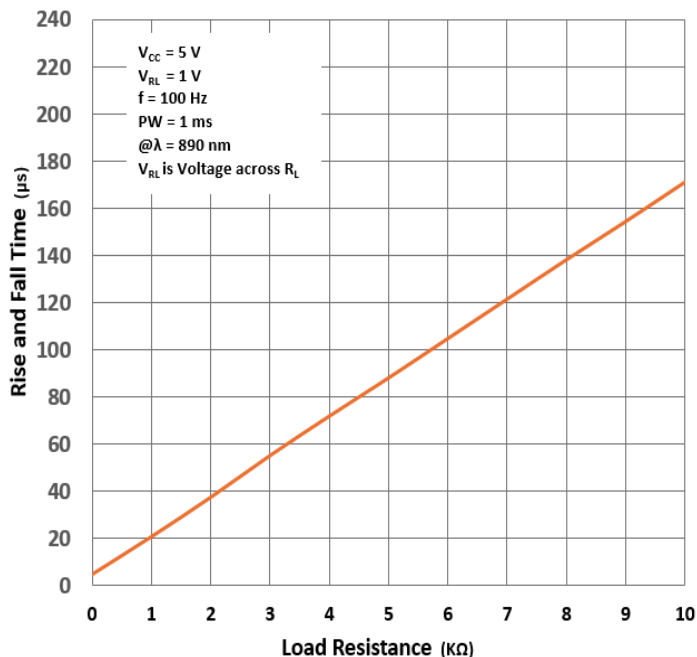

On-State Collector Current vs Irradiance

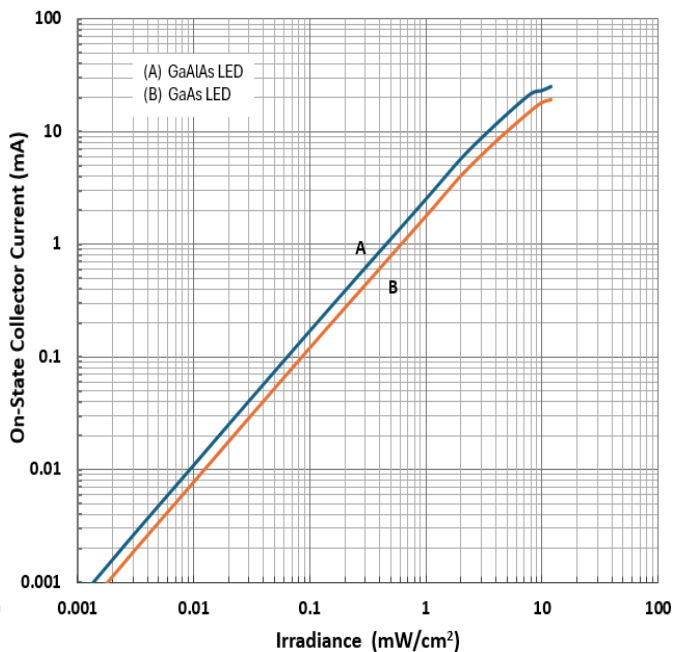

General Note

TT Electronics reserves the right to make changes in product specification without notice or liability. All information is subject to TT Electronics' own data and is considered accurate at time of going to print.

TT Electronics | OPTEK Technology
 2900 E. Plano Pkwy, Plano, TX 75074 | Ph: +1 972 323 2200
www.ttelectronics.com | sensors@ttelectronics.com

Typical Performance

OP509A, OP509B

Typical Spectral Response

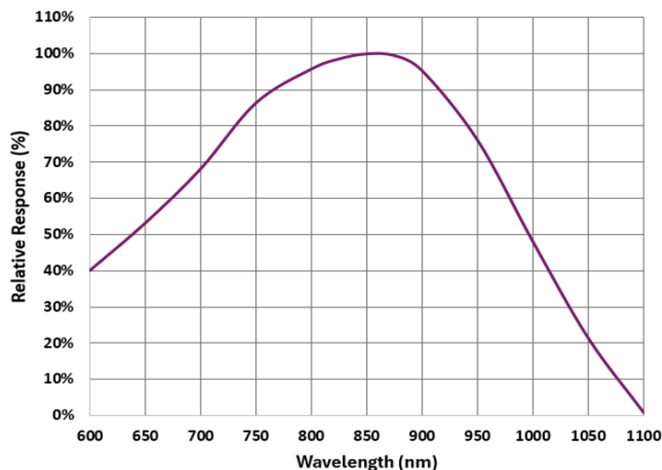

Normalized Collector Current vs Angular Displacement

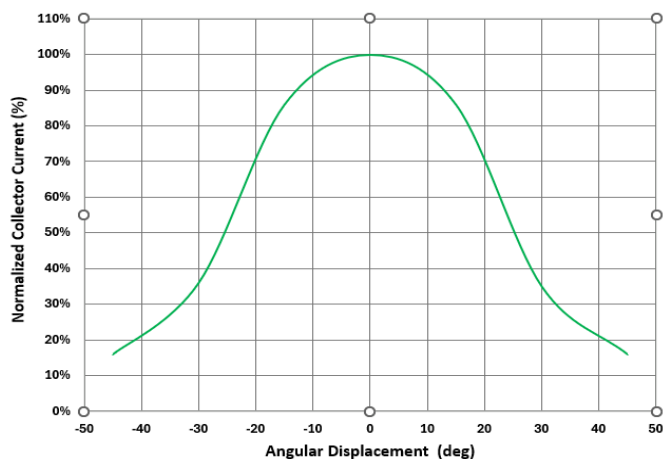

Rise and Fall Times vs Load Resistance

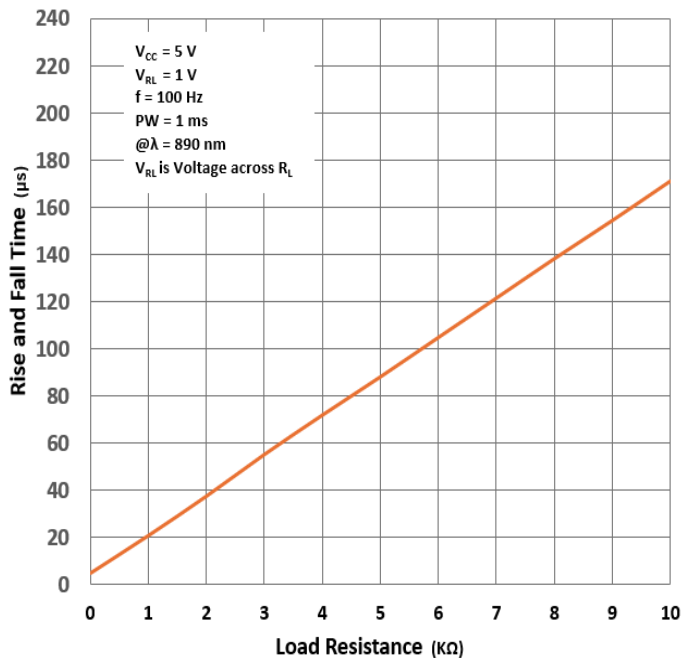

On-State Collector Current vs Irradiance

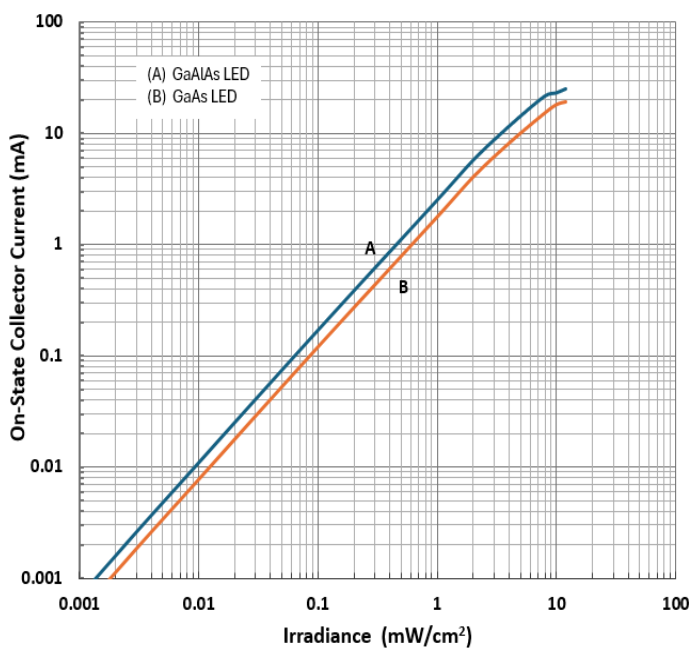

General Note

TT Electronics reserves the right to make changes in product specification without notice or liability. All information is subject to TT Electronics' own data and is considered accurate at time of going to print.