

Data Sheet | Item Number: 733-332

THT male header; 0.8 x 0.8 mm solder pin; straight; 100% protected against mismatching; Pin spacing 2.5 mm; 2-pole; light gray

<https://www.wago.com/733-332>

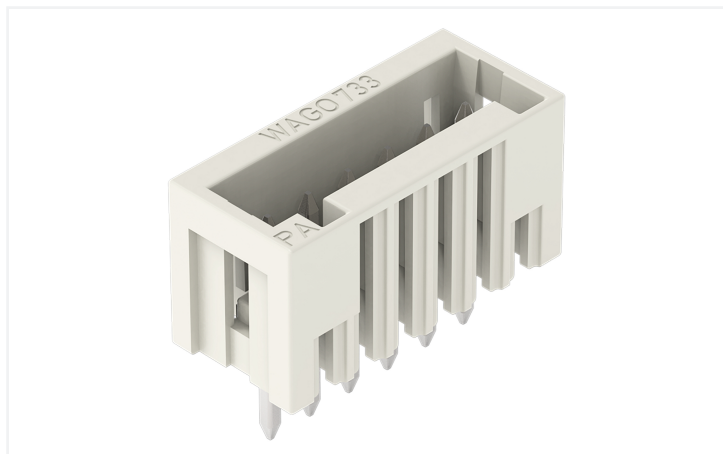

Color: ■ light gray

Similar to illustration

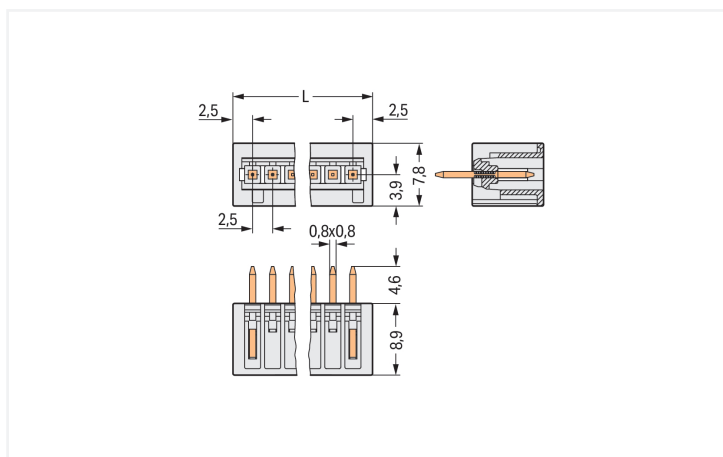
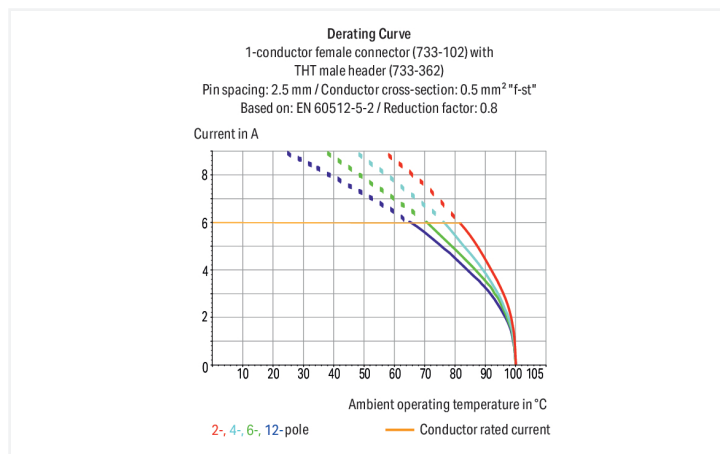

Dimensions in mm

L = (pole no. + 1) x pin spacing

Male connector, 733 Series, with 2.5 mm pin spacing

Enjoy effortless electrical installations with this male connector (item number 733-332). The item's dimensions are (7.5 x 13.5 x 7.8) mm (width x height x depth).

The contact surface is coated with tin. The pcb connector is designed for THT soldering.

Notes

Safety Information

The MCS – MULTI CONNECTION SYSTEM includes connectors without breaking capacity in accordance with DIN EN 61984. When used as intended, these connectors must not be connected/disconnected when live or under load. When used as intended, these connectors must not be connected/disconnected when live or under load. The circuit design should ensure header pins, which can be touched, are not live when unmated.

Variants:

Other pole numbers
3.8 mm pin projection for male headers with straight solder pins
Gold-plated or partially gold-plated contact surfaces
Other versions (or variants) can be requested from WAGO Sales or configured at <https://configurator.wago.com/>.

Electrical data

Ratings per	IEC/EN 60664-1		
Overvoltage category	III	III	II
Pollution degree	3	2	2
Nominal voltage	80 V	160 V	320 V
Rated impulse withstand voltage	2.5 kV	2.5 kV	2.5 kV
Rated current	6 A	6 A	6 A

Approvals per	UL 1059		
Use group	B	C	D
Rated voltage	150 V	-	-
Rated current	4 A	-	-

Approvals per	CSA		
Use group	B	C	D
Rated voltage	150 V	-	-
Rated current	4 A	-	-

Connection Data

Total number of potentials	2
Number of connection types	1
Number of levels	1

Connection 1

Pole number	2
-------------	---

Physical data

Pin spacing	2.5 mm / 0.098 inches
Width	7.5 mm / 0.295 inches
Height	13.5 mm / 0.531 inches
Height from the surface	8.9 mm / 0.35 inches
Depth	7.8 mm / 0.307 inches
Solder pin length	4.6 mm
Solder pin dimensions	0.8 x 0.8 mm
Drilled hole diameter	1.1 (+0.1) mm

Mechanical data

Variable coding	Yes
Anti-rotation protection	Yes

Plug-in connection

Contact type (pluggable connector)	Male connector/plug
Connector (connection type)	for PCB
Mismating protection	Yes
Mating direction to the PCB	90 °

PCB contact

PCB contact	THT
Solder pin arrangement	over the entire male connector (in-line)
Number of solder pins per potential	1

Material data

Note (material data)	Information on material specifications can be found here
Color	light gray
Material group	I
Insulation material (main housing)	Polyamide (PA66)
Flammability class per UL94	V0
Contact material	Electrolytic copper (E _{Cu})
Contact Plating	Tin
Fire load	0.007 MJ
Weight	0.4 g

Environmental requirements

Limit temperature range	-60 ... +100 °C	Environmental Testing
Processing temperature	-35 ... +60 °C	
		Test specification: Railway applications – Rolling stock – Electronic equipment
		DIN EN 50155 (VDE 0115-200):2022-06
		Test procedure: Railway applications – Rolling stock equipment – Vibration and shock tests
		DIN EN 61373 (VDE 0115-0106):2011-04
		Spectrum/Mounting location
		Service life test, Category 1, Class A/B
		Functional test with noise-like oscillations
		Test passed according to Section 8 of the standard
		Frequency
		f ₁ = 5 Hz to f ₂ = 150 Hz
		Acceleration
		0.101g (highest test level used for all axes)
		Test duration per axis
		10 min.
		Test directions
		X, Y and Z axes
		Monitoring of contact faults and interruptions
		Passed
		Voltage drop measurement before and after each axis
		Passed
		Simulated service life test through increased levels of noise-like oscillations
		Test passed according to Section 9 of the standard
		Frequency
		f ₁ = 5 Hz to f ₂ = 150 Hz
		Acceleration
		0.572g (highest test level used for all axes)
		Test duration per axis
		5 h
		Test directions
		X, Y and Z axes
		Extended testing: Monitoring of contact faults and interruptions
		Passed
		Extended testing: Voltage drop measurement before and after each axis
		Passed
		Shock test
		Test passed according to Section 10 of the standard
		Shock pulse form
		Half sine



Environmental Testing	
Acceleration	5g (highest test level used for all axes)
Shock duration	30 ms
Number of shocks (per axis)	3 pos. und 3 neg.
Test directions	X, Y and Z axes
Extended testing: Monitoring of contact faults and interruptions	Passed
Extended testing: Voltage drop measurement before and after each axis	Passed
Vibration and shock stress for rolling stock equipment	Passed

Commercial data	
Product Group	3 (Multi Conn. System)
PU (SPU)	200 pcs
Packaging type	Box
Country of origin	PL
GTIN	4050821035596
Customs tariff number	85366930000

Product Classification	
UNSPSC	39121409
eCl@ss 10.0	27-44-04-02
eCl@ss 9.0	27-44-04-02
ETIM 9.0	EC002637
ETIM 10.0	EC002637
ECCN	NO US CLASSIFICATION

Environmental Product Compliance	
RoHS Compliance Status	Compliant, No Exemption

Approvals / Certificates

General approvals		
  		
Approval	Standard	Certificate Name
CCA DEKRA Certification B.V.	EN 61984	2169534.01
CCA DEKRA Certification B.V.	IEC 61984	NL-31141
CSA DEKRA Certification B.V.	C22.2	1465035
UL UL International Germany GmbH	UL 1977	E45171

Declarations of conformity and manufacturer's declarations		
		
Approval	Standard	Certificate Name
Railway WAGO GmbH & Co. KG	-	Railway Ready

Approvals for marine applications



Approval	Standard	Certificate Name
ABS American Bureau of Ship- ping	-	24-0095975-PDA
DNV DNV GL SE	-	TAE000016Z
LR Lloyds Register	IEC 61984	96/20035 (E5)
PRS Polski Rejestr Statków	-	TE/1095/880590/23

Downloads

Environmental Product Compliance

Compliance Search
Environmental Product Compliance 733-332 ↓

Documentation

Additional Information			
Technical Section	03.04.2019	pdf 2027.26 KB	↓

CAD/CAE-Data

CAD data
2D/3D Models 733-332 ↓

CAE data
EPLAN Data Portal 733-332 ↓
ZUKEN Portal 733-332 ↓

PCB Design

Symbol and Footprint via SamacSys 733-332 ↓
Symbol and Footprint via Ultra Librarian 733-332 ↓

1 Compatible Products

1.1 System counterpart

1.1.1 Female connector/socket



Item No.: [733-102/037-000](#)

1-conductor female connector; CAGE CLAMP®; 0.5 mm²; Pin spacing 2.5 mm; 2-pole; 100% protected against mismatching; Lateral locking levers; 0,50 mm²; light gray



Item No.: [733-102/037-004](#)

1-conductor female connector; CAGE CLAMP®; 0.5 mm²; Pin spacing 2.5 mm; 2-pole; 100% protected against mismatching; Lateral locking levers; black



Item No.: [733-102/037-000/032-000](#)

1-conductor female connector; CAGE CLAMP®; 0.5 mm²; Pin spacing 2.5 mm; 2-pole; 100% protected against mismatching; Lateral locking levers; Strain relief plate; 0,50 mm²; light gray



Item No.: [733-102](#)

1-conductor female connector; CAGE CLAMP®; 0.5 mm²; Pin spacing 2.5 mm; 2-pole; 100% protected against mismatching; light gray

1.2 Optional Accessories

1.2.1 Coding

1.2.1.1 Coding



Item No.: [733-331](#)

Coding key; snap-on type; black



Item No.: [733-330](#)

Coding key; snap-on type; white

Installation Notes

Mismatching protection

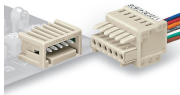

Male headers and female connectors are 100% protected against mismatching. Only mating halves with the same pole number can be connected.

Coding



Coding a male header – fitting coding key (s).