

STRADA-2X2-ME-WIDE2

Beam with excellent longitudinal luminance uniformity for staggered pole setups fulfilling EN13201 M-class requirements where road width is equal to or less than the pole height

SPECIFICATION:

Dimensions	50.0 x 50.0
Height	7 mm
Fastening	pin, screw
ROHS compliant	yes ⓘ



MATERIALS:

Component	Type	Material	Colour	Finish	Length (mm)
STRADA-2X2-ME-WIDE2	Multi-lens	PMMA	clear		

ORDERING INFORMATION:

Component	Qty in box	MOQ	MPQ	Box weight (kg)
C14165_STRADA-2X2-ME-WIDE2 » Box size: 480 x 280 x 300 mm	800	160	160	7.6

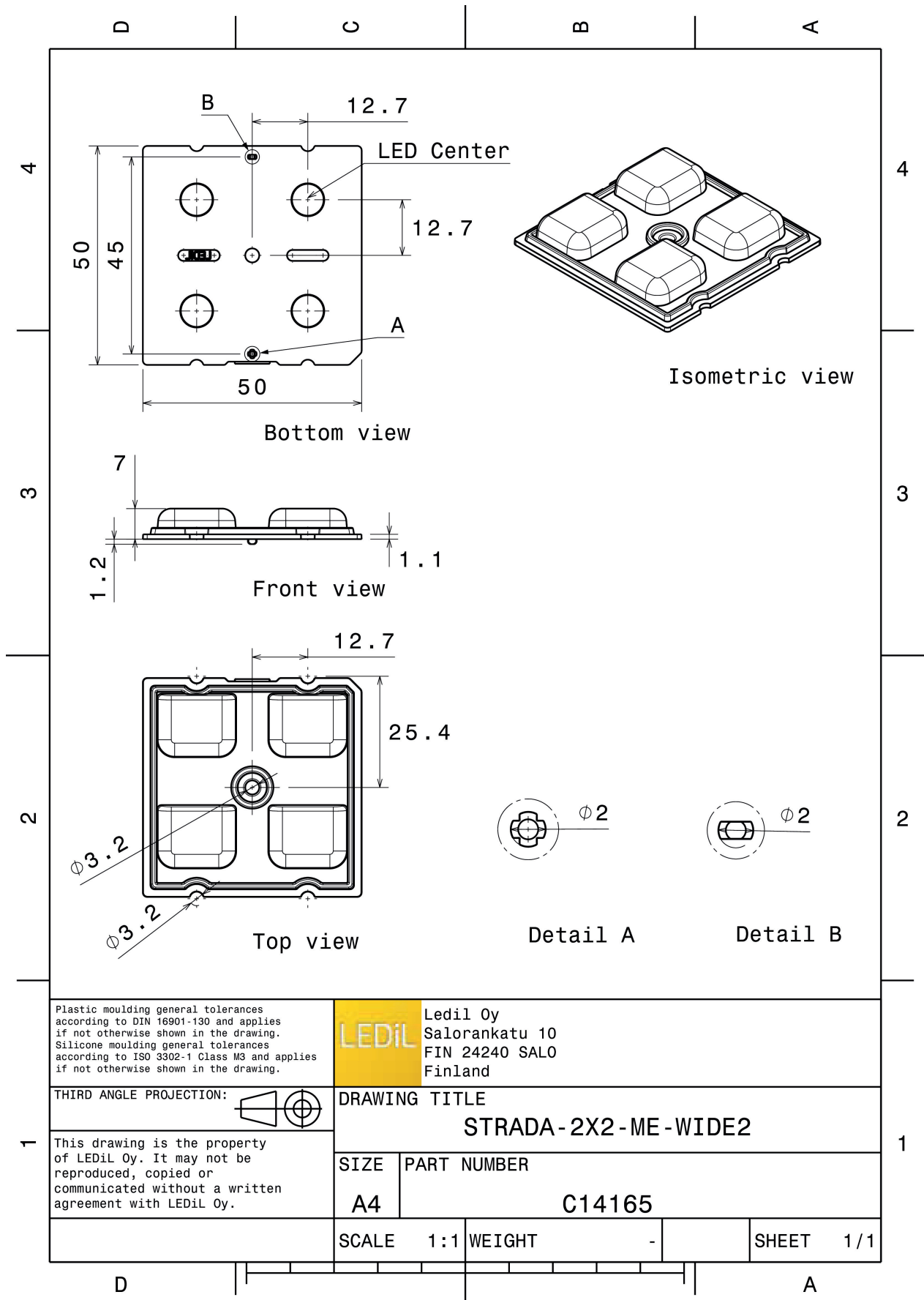

Plastic moulding general tolerances according to DIN 16901-130 and applies if not otherwise shown in the drawing. Silicone moulding general tolerances according to ISO 3302-1 Class M3 and applies if not otherwise shown in the drawing.

LEDiL Ledit Oy
Salorankatu 10
FIN 24240 SALO
Finland

THIRD ANGLE PROJECTION:

DRAWING TITLE
STRADA-2X2-ME-WIDE2

This drawing is the property of LEDiL Oy. It may not be reproduced, copied or communicated without a written agreement with LEDiL Oy.

SIZE	PART NUMBER
A4	C14165

SCALE	1:1	WEIGHT	-	SHEET	1/1
-------	-----	--------	---	-------	-----

See also our general installation guide: www.ledil.com/installation_guide

OPTICAL RESULTS (MEASURED):



LED XD16
 FWHM / FWTM Asymmetric
 Efficiency 94 %
 Peak intensity 1.4 cd/lm
 LEDs/each optic 1
 Light colour/type White
 Required components:

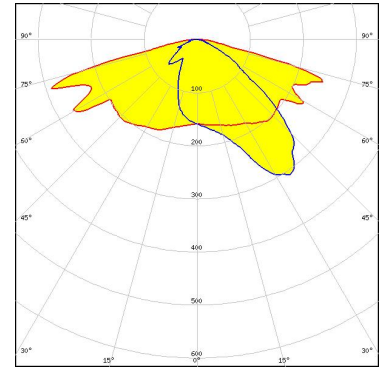

Light distribution files



LED XD16
 FWHM / FWTM Asymmetric
 Efficiency 94 %
 Peak intensity 0.6 cd/lm
 LEDs/each optic 4
 Light colour/type White
 Required components:

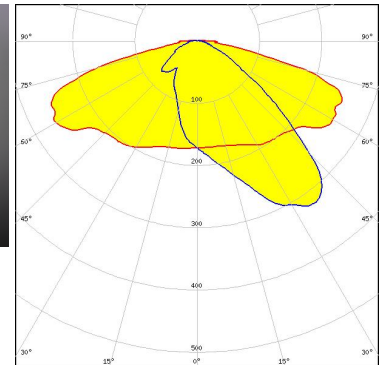
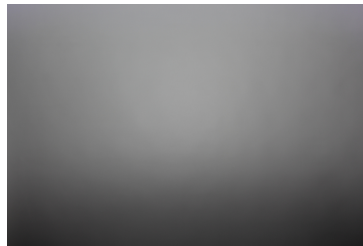

Light distribution files



LED XP-G2
 FWHM / FWTM Asymmetric
 Efficiency 79 %
 Peak intensity 0.8 cd/lm
 LEDs/each optic 1
 Light colour/type White
 Required components:

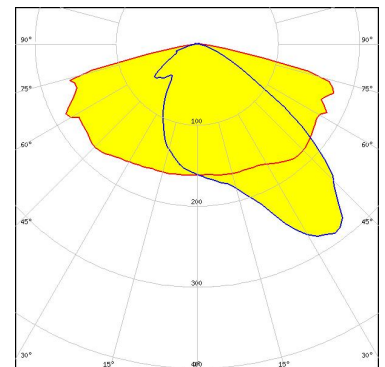

Protective plate, glass

Light distribution files

OPTICAL RESULTS (MEASURED):



LED XP-G3
 FWHM / FWTM Asymmetric
 Efficiency 84 %
 Peak intensity 0.7 cd/lm
 LEDs/each optic 1
 Light colour/type White
 Required components:

Protective plate, glass

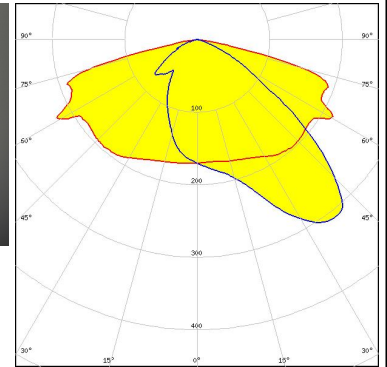

Light distribution files



LED XP-G3
 FWHM / FWTM Asymmetric
 Efficiency 87 %
 Peak intensity 0.9 cd/lm
 LEDs/each optic 1
 Light colour/type White
 Required components:
 C17580_STRADA-2X2-SHD-WHT

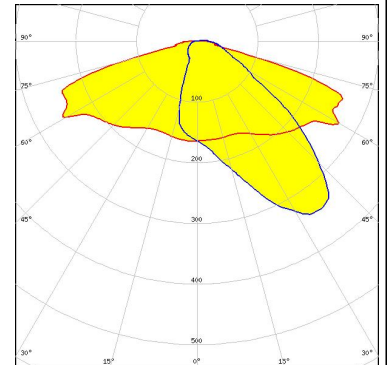

Light distribution files



LED XP-G3
 FWHM / FWTM Asymmetric
 Efficiency 72 %
 Peak intensity 0.8 cd/lm
 LEDs/each optic 1
 Light colour/type White
 Required components:
 C17677_STRADA-2X2-SHD-BLK

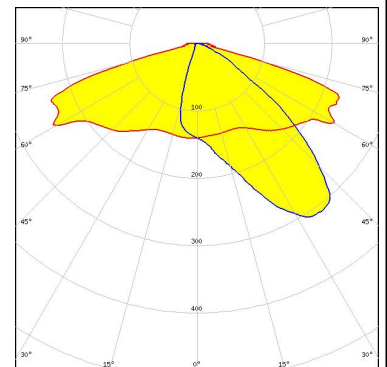

Light distribution files

OPTICAL RESULTS (MEASURED):



LED XP-L2
FWHM / FWTM Asymmetric
Efficiency 83 %
Peak intensity 0.5 cd/lm
LEDs/each optic 1
Light colour/type White
Required components:

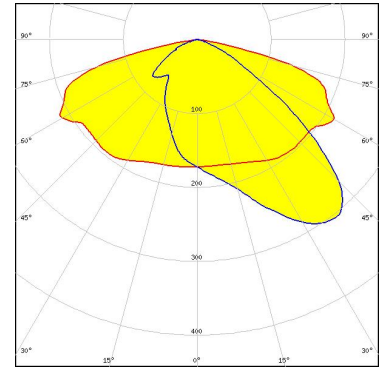

Light distribution files



LED LUXEON V
FWHM / FWTM Asymmetric
Efficiency 94 %
Peak intensity 0.6 cd/lm
LEDs/each optic 1
Light colour/type White
Required components:

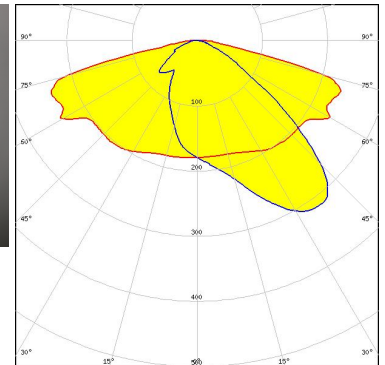
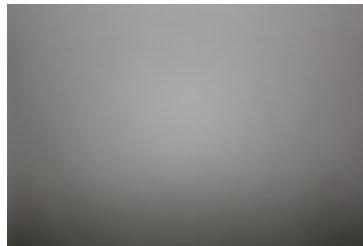

Light distribution files



LED RecLED 122x50mm 1900lm 730 2x4 Opt G1
FWHM / FWTM Asymmetric
Efficiency 95 %
Peak intensity 1.1 cd/lm
LEDs/each optic 1
Light colour/type White
Required components:

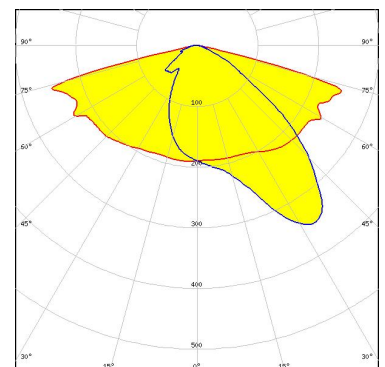

Light distribution files

OPTICAL RESULTS (MEASURED):



LED NVSW219F-V2
FWHM / FWTM Asymmetric
Efficiency 94 %
Peak intensity 0.9 cd/lm
LEDs/each optic 1
Light colour/type White
Required components:

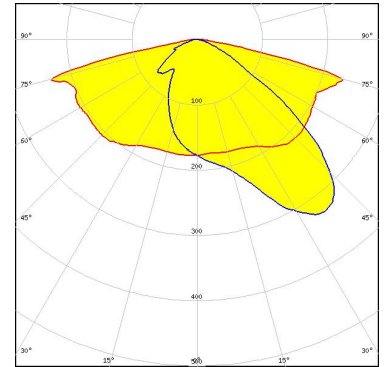

Light distribution files



LED NVSW319B
FWHM / FWTM Asymmetric
Efficiency 94 %
Peak intensity 0.9 cd/lm
LEDs/each optic 1
Light colour/type White
Required components:

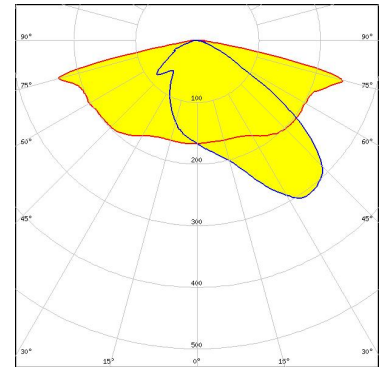

Light distribution files



LED NVSW3x9A
FWHM / FWTM Asymmetric
Efficiency 85 %
Peak intensity 0.7 cd/lm
LEDs/each optic 1
Light colour/type White
Required components:

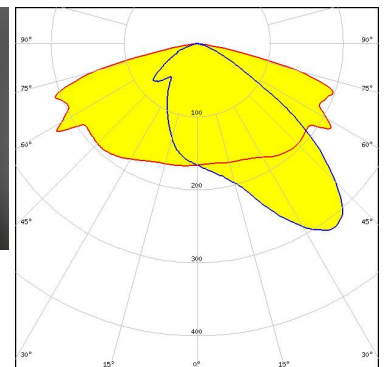
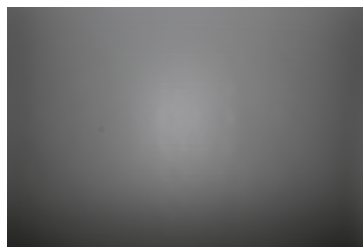

Light distribution files

OPTICAL RESULTS (MEASURED):

PHILIPS

LED Fortimo FastFlex LED 2x8 DA G4
FWHM / FWTM Asymmetric
Efficiency 86 %
Peak intensity 0.9 cd/lm
LEDs/each optic 1
Light colour/type White
Required components:

Protective plate, glass

Light distribution files

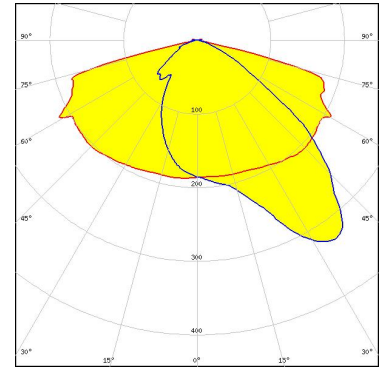

PHILIPS

LED Fortimo FastFlex LED 2x8 DA G4+
FWHM / FWTM Asymmetric
Efficiency 94 %
Peak intensity 0.8 cd/lm
LEDs/each optic 1
Light colour/type White
Required components:

Light distribution files

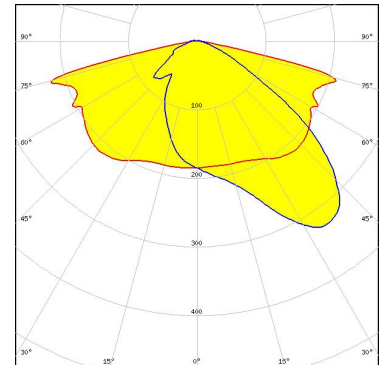

PHILIPS

LED Fortimo FastFlex LED 2x8 DA G5
FWHM / FWTM Asymmetric
Efficiency 97 %
Peak intensity 1 cd/lm
LEDs/each optic 1
Light colour/type White
Required components:

Light distribution files

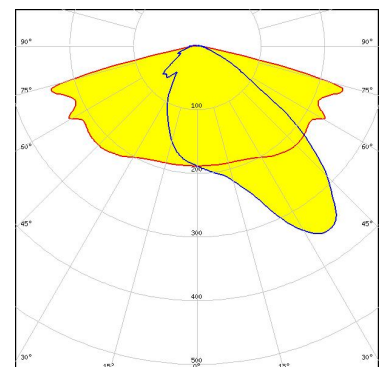

OPTICAL RESULTS (MEASURED):

PHILIPS

LED Fortimo FastFlex LED 2x8 DAX G4
FWHM / FWTM Asymmetric
Efficiency 84 %
Peak intensity 0.7 cd/lm
LEDs/each optic 1
Light colour/type White
Required components:

Protective plate, glass

Light distribution files

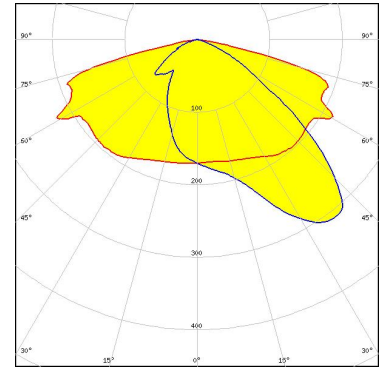

SAMSUNG

LED HiLOM RC12 Z (LH181B)
FWHM / FWTM Asymmetric
Efficiency 99 %
Peak intensity 1.2 cd/lm
LEDs/each optic 1
Light colour/type White
Required components:

Light distribution files

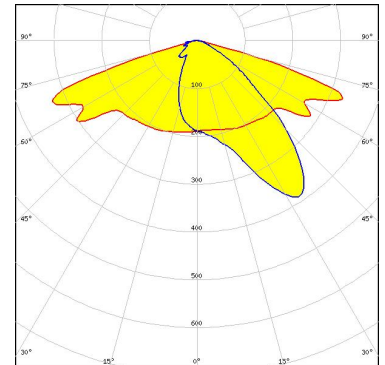

SAMSUNG

LED HiLOM RH12 Z (LH351C)
FWHM / FWTM Asymmetric
Efficiency 97 %
Peak intensity 0.9 cd/lm
LEDs/each optic 1
Light colour/type White
Required components:

Light distribution files

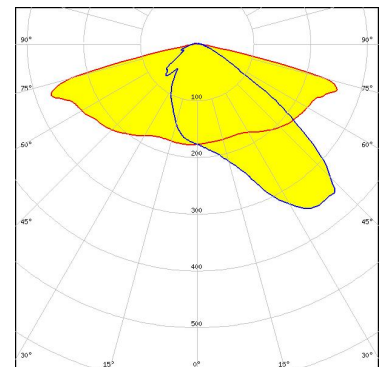

OPTICAL RESULTS (MEASURED):

SAMSUNG

LED HiLOM RH16 (LH351C)
FWHM / FWTM Asymmetric
Efficiency 94 %
Peak intensity 0.8 cd/lm
LEDs/each optic 1
Light colour/type White
Required components:

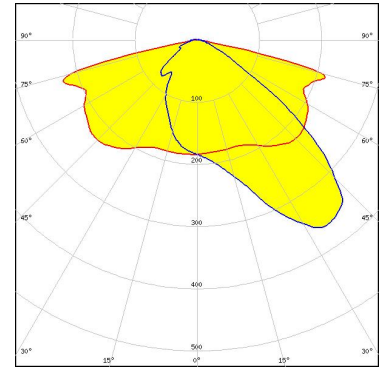

Light distribution files

SAMSUNG

LED LH351B
FWHM / FWTM Asymmetric
Efficiency 94 %
Peak intensity 0.9 cd/lm
LEDs/each optic 1
Light colour/type White
Required components:

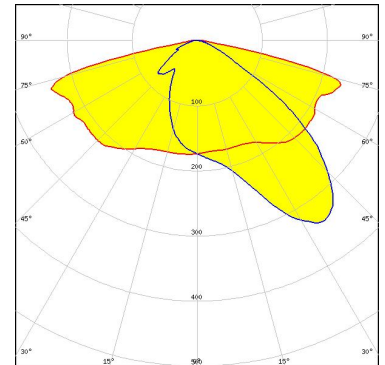

Light distribution files



LED LED-Pa-L15c2W11c2-xxx-C050-01
FWHM / FWTM Asymmetric
Efficiency 97 %
Peak intensity 1.1 cd/lm
LEDs/each optic 1
Light colour/type White
Required components:

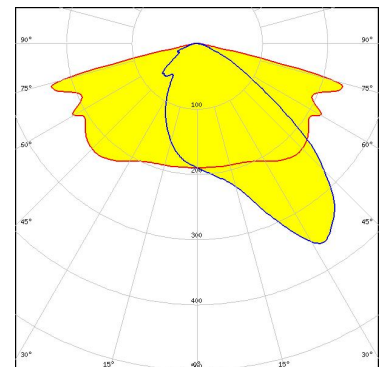

Light distribution files

OPTICAL RESULTS (MEASURED):

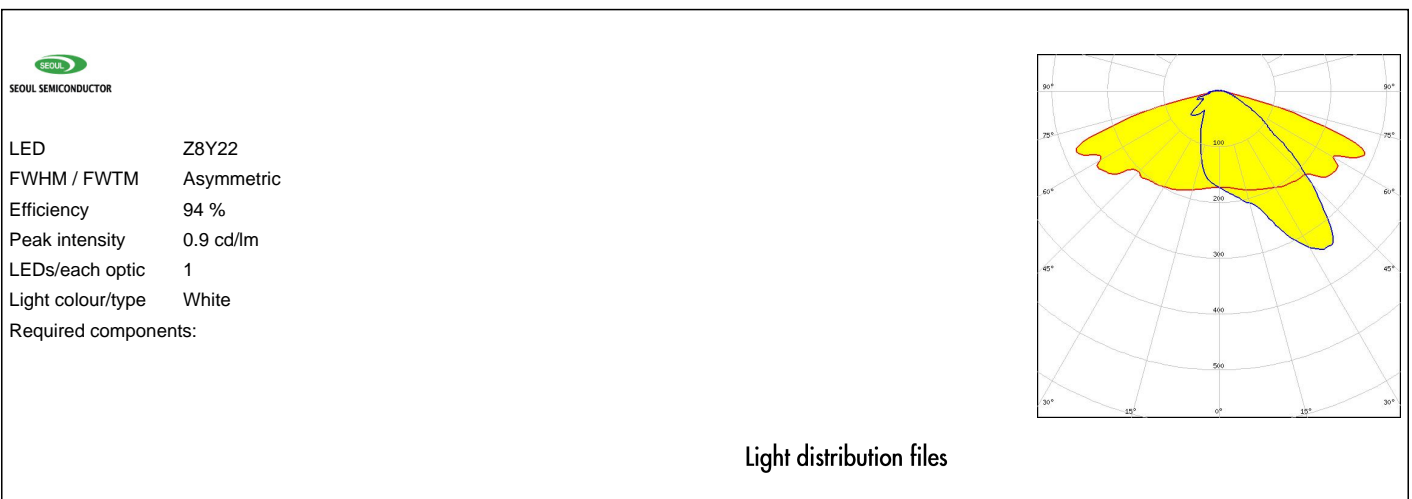
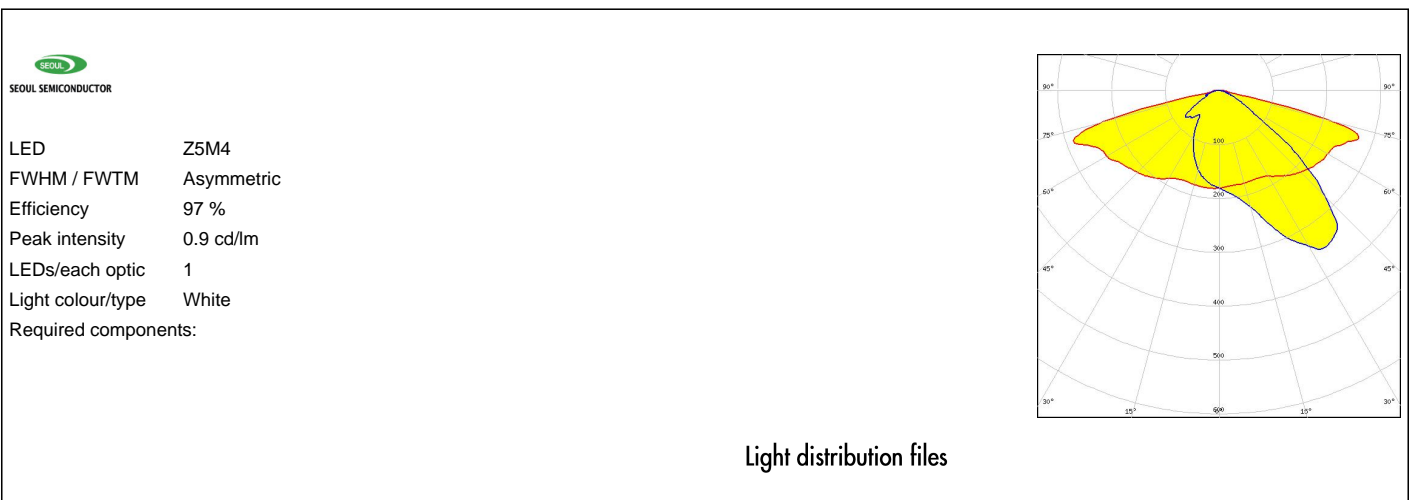
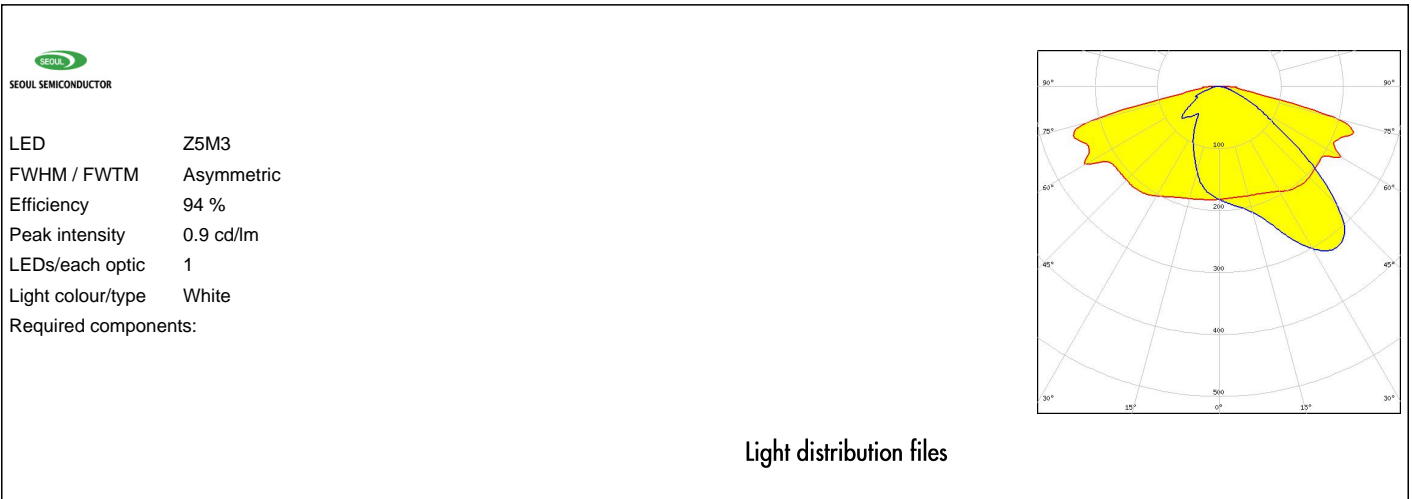

OPTICAL RESULTS (MEASURED):

TOSHIBA

Leading Innovation >>>

LED TL1L4
FWHM / FWTM Asymmetric
Efficiency 81 %
Peak intensity 0.8 cd/lm
LEDs/each optic 1
Light colour/type White
Required components:

Protective plate, glass

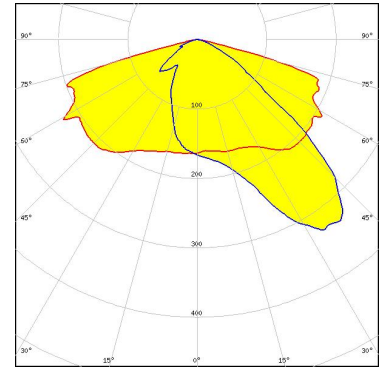

Light distribution files

TRIDONIC

LED RLE 2x4 2000lm HP EXC2 OTD
FWHM / FWTM Asymmetric
Efficiency 94 %
Peak intensity 1.3 cd/lm
LEDs/each optic 1
Light colour/type White
Required components:

Light distribution files

TRIDONIC

LED RLE 2x8 4000lm HP EXC2 OTD
FWHM / FWTM Asymmetric
Efficiency 94 %
Peak intensity 1.3 cd/lm
LEDs/each optic 1
Light colour/type White
Required components:

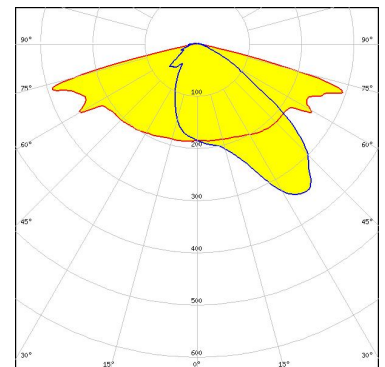

Light distribution files

OPTICAL RESULTS (MEASURED):

TRIDONIC

LED RLE G1 49x121mm 2000lm xxx EXC OTD
FWHM / FWTM Asymmetric
Efficiency 94 %
Peak intensity 1.3 cd/lm
LEDs/each optic 1
Light colour/type White
Required components:

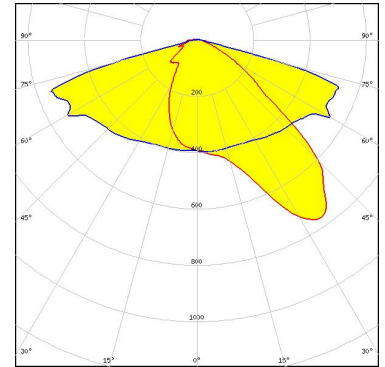

Light distribution files

TRIDONIC

LED RLE G1 49x133mm 2000lm xxx EXC OTD
FWHM / FWTM Asymmetric
Efficiency 94 %
Peak intensity 1.3 cd/lm
LEDs/each optic 1
Light colour/type White
Required components:

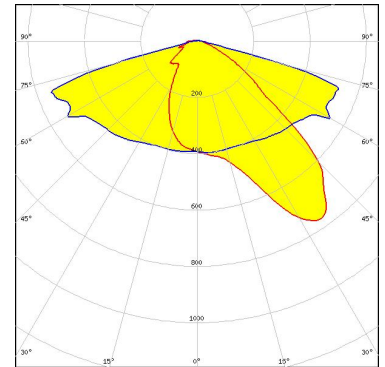

Light distribution files

TRIDONIC

LED RLE G1 49x223mm 4000lm xxx EXC OTD
FWHM / FWTM Asymmetric
Efficiency 94 %
Peak intensity 1.3 cd/lm
LEDs/each optic 1
Light colour/type White
Required components:

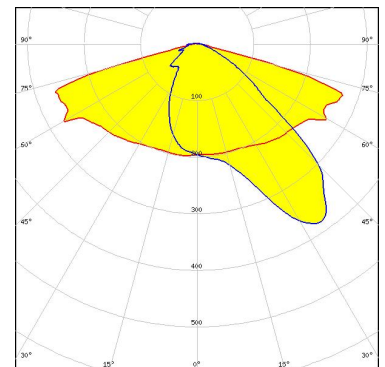

Light distribution files

OPTICAL RESULTS (MEASURED):

TRIDONIC

LED RLE G1 49x245mm 4000lm xxx EXC OTD
FWHM / FWTM Asymmetric
Efficiency 94 %
Peak intensity 1.3 cd/lm
LEDs/each optic 1
Light colour/type White
Required components:

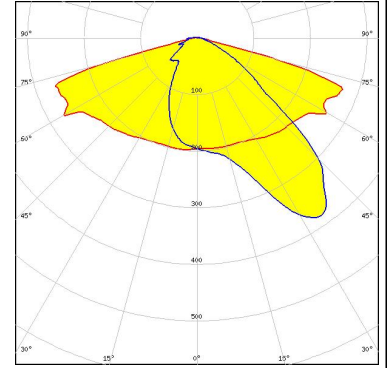

Light distribution files

OPTICAL RESULTS (SIMULATED):



LED Bridgelux SMD 3535 (3B1)
FWHM / FWTM Asymmetric
Efficiency 80 %
Peak intensity 0.5 cd/lm
LEDs/each optic 1
Light colour/type White
Required components:

Protective plate, glass

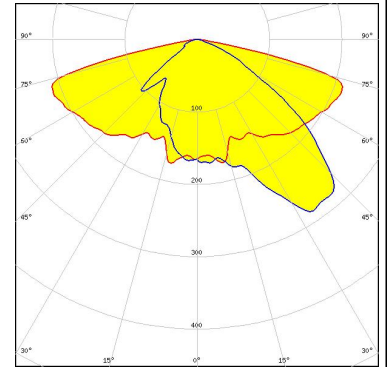

Light distribution files



LED Bridgelux SMD 3535 (3B1)
FWHM / FWTM Asymmetric
Efficiency 96 %
Peak intensity 0.9 cd/lm
LEDs/each optic 1
Light colour/type White
Required components:

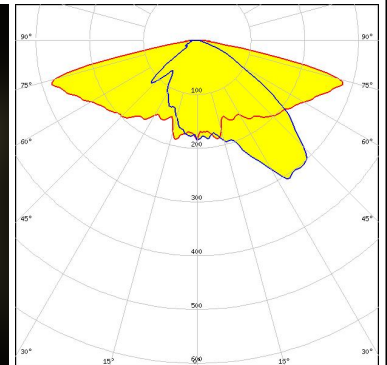
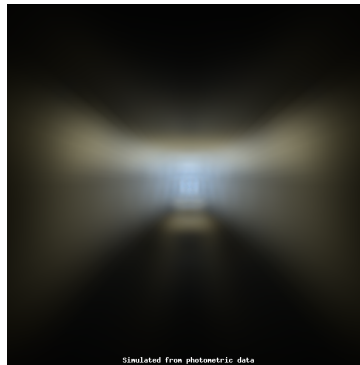

Light distribution files



LED XHP35 HD
FWHM / FWTM Asymmetric
Efficiency 94 %
Peak intensity 0.5 cd/lm
LEDs/each optic 1
Light colour/type White
Required components:

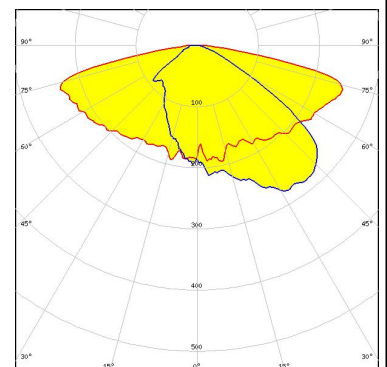

Light distribution files

OPTICAL RESULTS (SIMULATED):



LED XP-E2
 FWHM / FWTM Asymmetric
 Efficiency 81 %
 Peak intensity 0.6 cd/lm
 LEDs/each optic 1
 Light colour/type White
 Required components:

Protective plate, glass

Light distribution files

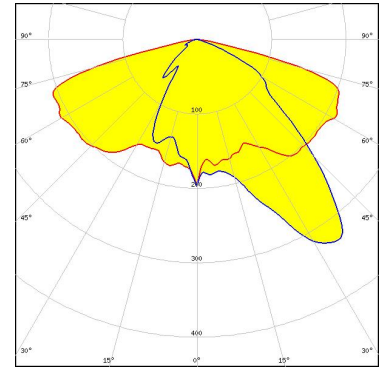

LED XP-G2
 FWHM / FWTM Asymmetric
 Efficiency 95 %
 Peak intensity 0.7 cd/lm
 LEDs/each optic 1
 Light colour/type White
 Required components:

Light distribution files

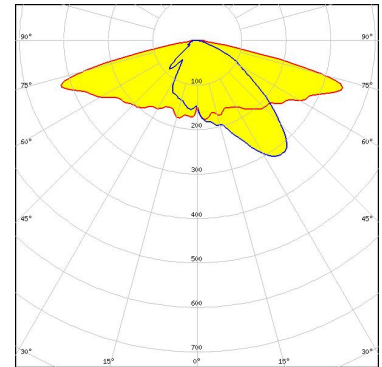

LED XP-G2
 FWHM / FWTM Asymmetric
 Efficiency 81 %
 Peak intensity 0.6 cd/lm
 LEDs/each optic 1
 Light colour/type White
 Required components:

Protective plate, glass

Light distribution files

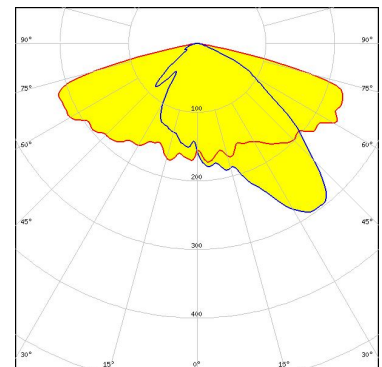

OPTICAL RESULTS (SIMULATED):



LED XP-G2 HE
 FWHM / FWTM Asymmetric
 Efficiency 92 %
 Peak intensity 0.7 cd/lm
 LEDs/each optic 1
 Light colour/type White
 Required components:

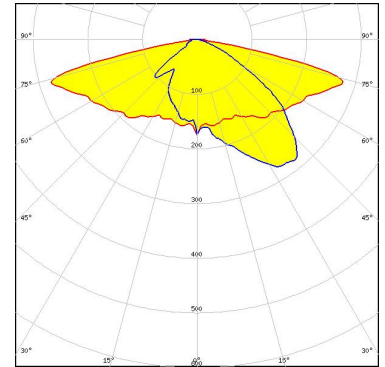

Light distribution files



LED XP-G3
 FWHM / FWTM Asymmetric
 Efficiency 62 %
 Peak intensity 0.5 cd/lm
 LEDs/each optic 1
 Light colour/type White
 Required components:
 C17677_STRADA-2X2-SHD-BLK

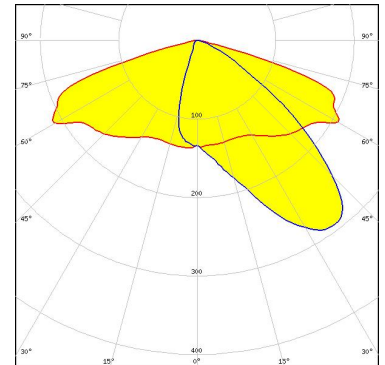

Light distribution files

Protective plate, glass



LED XP-G3
 FWHM / FWTM Asymmetric
 Efficiency 73 %
 Peak intensity 0.6 cd/lm
 LEDs/each optic 1
 Light colour/type White
 Required components:
 C17580_STRADA-2X2-SHD-WHT

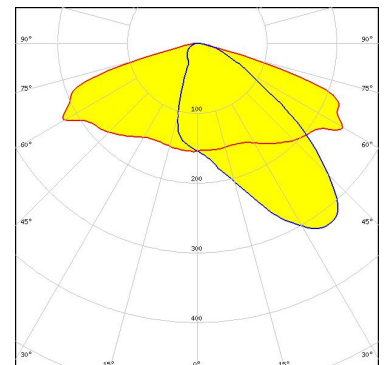

Light distribution files

Protective plate, glass

OPTICAL RESULTS (SIMULATED):



LED XP-G3
 FWHM / FWTM Asymmetric
 Efficiency 77 %
 Peak intensity 0.5 cd/lm
 LEDs/each optic 1
 Light colour/type White
 Required components:

Protective plate, glass

Light distribution files

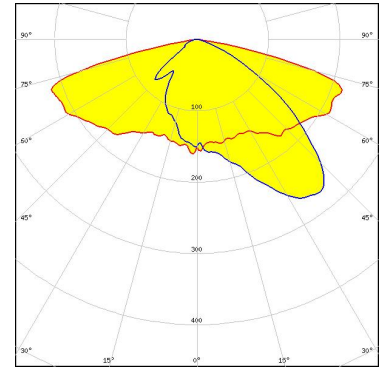

LED XP-G3
 FWHM / FWTM Asymmetric
 Efficiency 93 %
 Peak intensity 0.7 cd/lm
 LEDs/each optic 1
 Light colour/type White
 Required components:

Light distribution files

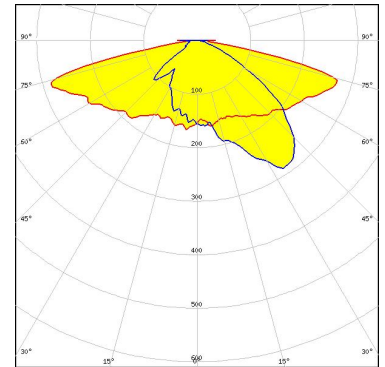

LED XP-G4
 FWHM / FWTM Asymmetric
 Efficiency 94 %
 Peak intensity 0.8 cd/lm
 LEDs/each optic 1
 Light colour/type White
 Required components:

Light distribution files

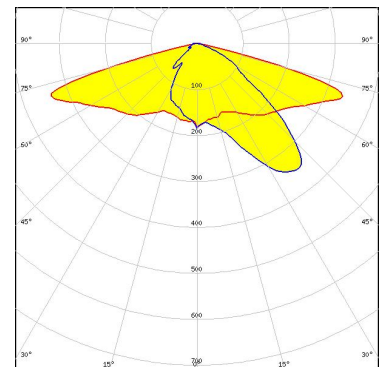

OPTICAL RESULTS (SIMULATED):



LED XP-G4
 FWHM / FWTM Asymmetric
 Efficiency 81 %
 Peak intensity 0.6 cd/lm
 LEDs/each optic 1
 Light colour/type White
 Required components:

Protective plate, glass

Light distribution files

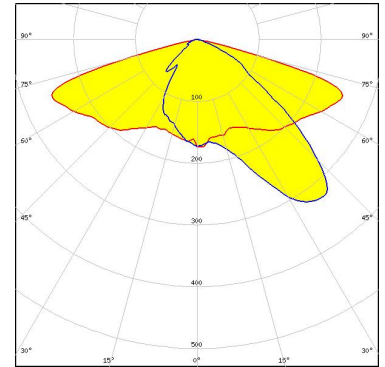

LED XP-L HD
 FWHM / FWTM Asymmetric
 Efficiency 90 %
 Peak intensity 0.7 cd/lm
 LEDs/each optic 1
 Light colour/type White
 Required components:

Light distribution files

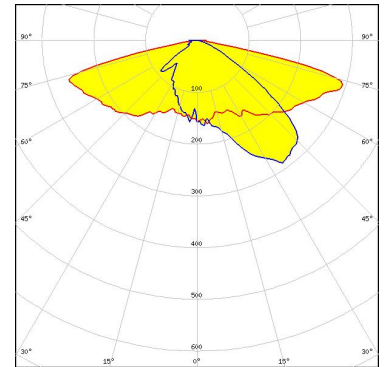

LED XP-L2
 FWHM / FWTM Asymmetric
 Efficiency 80 %
 Peak intensity 0.4 cd/lm
 LEDs/each optic 1
 Light colour/type White
 Required components:

Protective plate, glass

Light distribution files

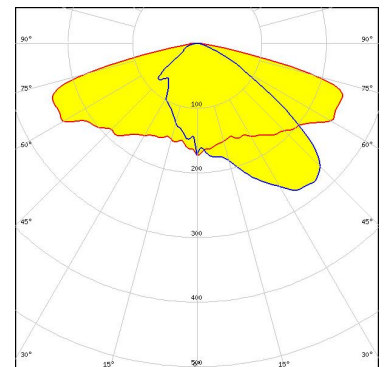

OPTICAL RESULTS (SIMULATED):



LED XT-E
 FWHM / FWTM Asymmetric
 Efficiency 80 %
 Peak intensity 0.7 cd/lm
 LEDs/each optic 1
 Light colour/type White
 Required components:

Protective plate, glass

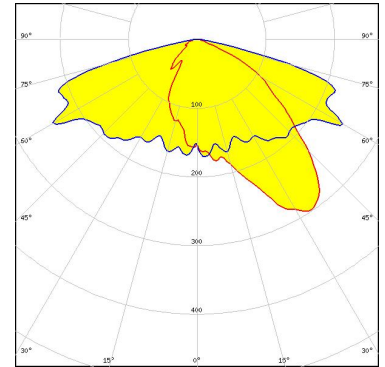

Light distribution files



LED PrevaLED Brick HP 2x8
 FWHM / FWTM Asymmetric
 Efficiency 92 %
 Peak intensity 0.9 cd/lm
 LEDs/each optic 1
 Light colour/type White
 Required components:

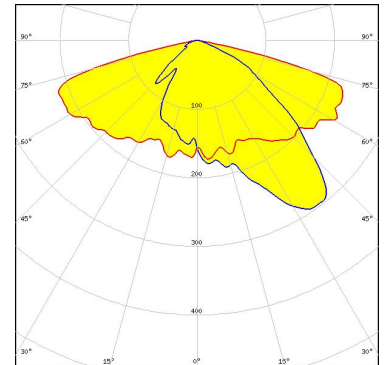

Light distribution files



LED LUXEON 3030 2D (Round LES)
 FWHM / FWTM Asymmetric
 Efficiency 82 %
 Peak intensity 0.7 cd/lm
 LEDs/each optic 1
 Light colour/type White
 Required components:

Protective plate, glass

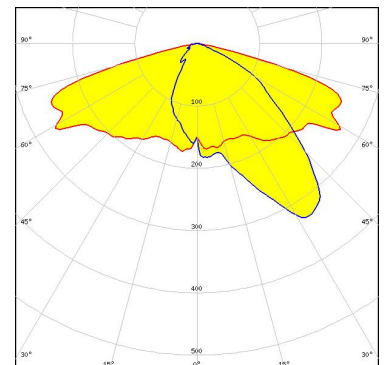

Light distribution files

OPTICAL RESULTS (SIMULATED):



LED LUXEON HL2X
 FWHM / FWTM Asymmetric
 Efficiency 80 %
 Peak intensity 0.5 cd/lm
 LEDs/each optic 1
 Light colour/type White
 Required components:

Protective plate, glass

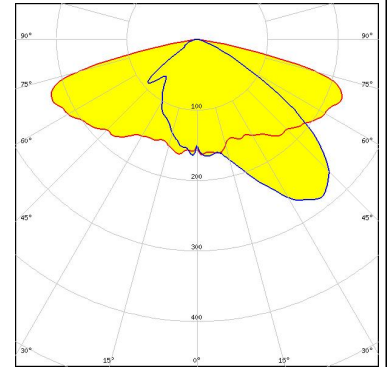

Light distribution files



LED LUXEON HL2X-V
 FWHM / FWTM Asymmetric
 Efficiency 81 %
 Peak intensity 0.5 cd/lm
 LEDs/each optic 1
 Light colour/type White
 Required components:

Protective plate, glass

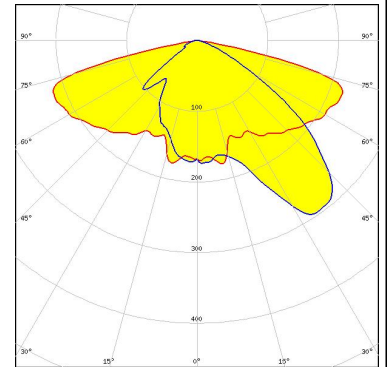

Light distribution files



LED LUXEON HL2X-V
 FWHM / FWTM Asymmetric
 Efficiency 96 %
 Peak intensity 0.8 cd/lm
 LEDs/each optic 1
 Light colour/type White
 Required components:

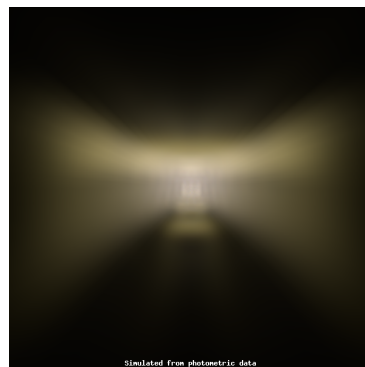

Simulated from photometric data

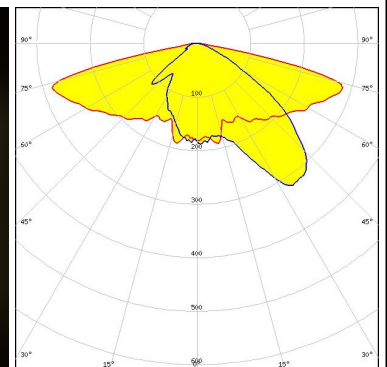

Light distribution files

OPTICAL RESULTS (SIMULATED):



LED LUXEON HL4X
 FWHM / FWTM Asymmetric
 Efficiency 96 %
 Peak intensity 0.7 cd/lm
 LEDs/each optic 1
 Light colour/type White
 Required components:

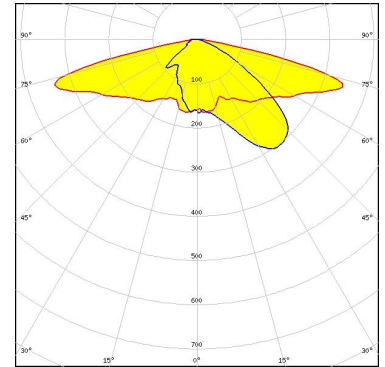

Light distribution files



LED LUXEON HL4X
 FWHM / FWTM Asymmetric
 Efficiency 80 %
 Peak intensity 0.5 cd/lm
 LEDs/each optic 1
 Light colour/type White
 Required components:

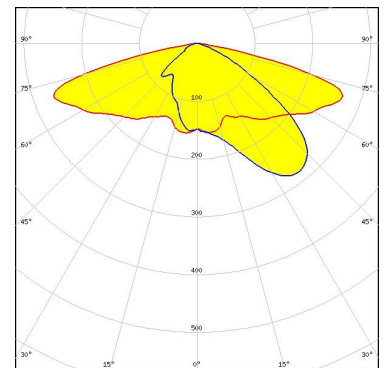

Protective plate, glass

Light distribution files



LED LUXEON XR-HL2X (L2H2-xxxxxxxMLU010)
 FWHM / FWTM Asymmetric
 Efficiency 81 %
 Peak intensity 0.4 cd/lm
 LEDs/each optic 1
 Light colour/type White
 Required components:

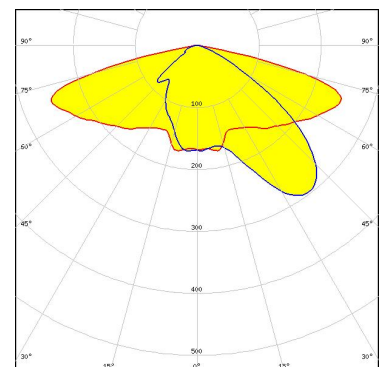

Protective plate, glass

Light distribution files

OPTICAL RESULTS (SIMULATED):



LED LUXEON XR-HL2X (L2H2-xxxxxxxMLU010)
FWHM / FWTM Asymmetric
Efficiency 96 %
Peak intensity 0.7 cd/lm
LEDs/each optic 1
Light colour/type White
Required components:

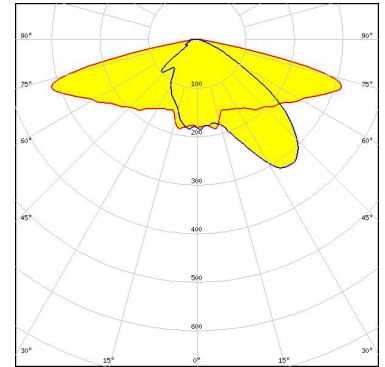

Light distribution files



LED NF2x757G
FWHM / FWTM Asymmetric
Efficiency 83 %
Peak intensity 0.6 cd/lm
LEDs/each optic 1
Light colour/type White
Required components:

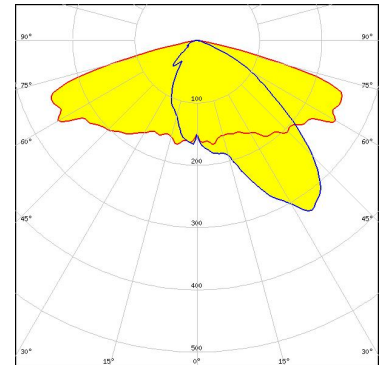

Protective plate, glass

Light distribution files



LED NV4WB35AM
FWHM / FWTM Asymmetric
Efficiency 95 %
Peak intensity 0.6 cd/lm
LEDs/each optic 1
Light colour/type White
Required components:

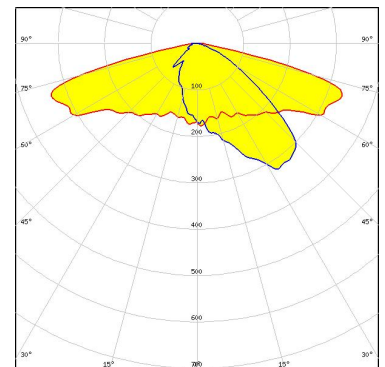

Light distribution files

OPTICAL RESULTS (SIMULATED):



LED NVSW219F-V2
FWHM / FWTM Asymmetric
Efficiency 80 %
Peak intensity 0.5 cd/lm
LEDs/each optic 1
Light colour/type White
Required components:

Protective plate, glass

Light distribution files

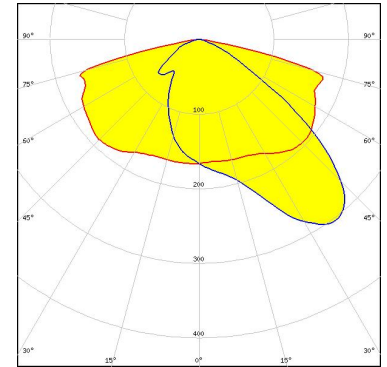

LED NVSW219F-V2
FWHM / FWTM Asymmetric
Efficiency 92 %
Peak intensity 0.7 cd/lm
LEDs/each optic 1
Light colour/type White
Required components:

Light distribution files

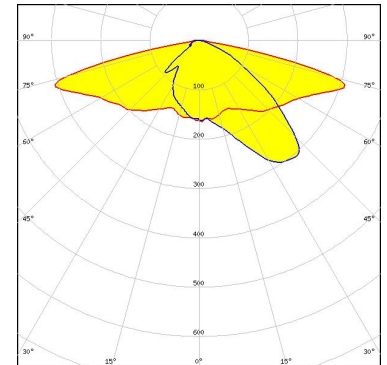

LED NVSW219GL
FWHM / FWTM Asymmetric
Efficiency 93 %
Peak intensity 0.8 cd/lm
LEDs/each optic 1
Light colour/type White
Required components:

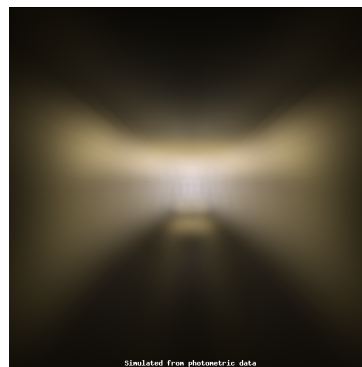

Light distribution files

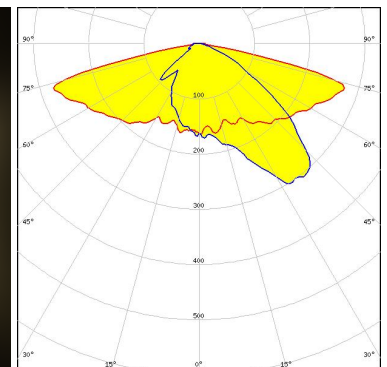

OPTICAL RESULTS (SIMULATED):



LED NVSW219GL
FWHM / FWTM Asymmetric
Efficiency 78 %
Peak intensity 0.5 cd/lm
LEDs/each optic 1
Light colour/type White
Required components:

Protective plate, glass

Light distribution files

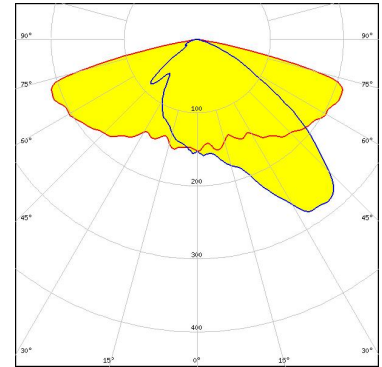

LED NVSW519A
FWHM / FWTM Asymmetric
Efficiency 82 %
Peak intensity 0.4 cd/lm
LEDs/each optic 1
Light colour/type White
Required components:

Protective plate, glass

Light distribution files

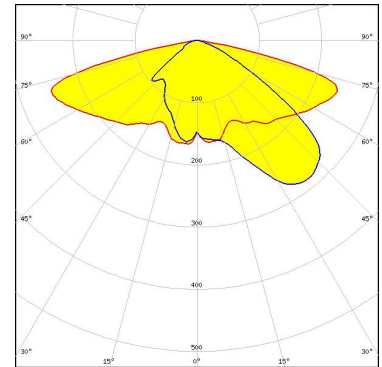

LED NVSW519A
FWHM / FWTM Asymmetric
Efficiency 92 %
Peak intensity 0.6 cd/lm
LEDs/each optic 1
Light colour/type White
Required components:

Light distribution files

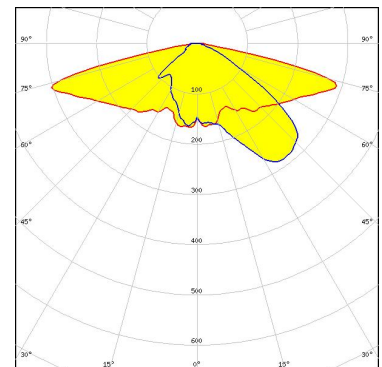

OPTICAL RESULTS (SIMULATED):



LED NVSxE21A
 FWHM / FWTM Asymmetric
 Efficiency 93 %
 Peak intensity 0.9 cd/lm
 LEDs/each optic 1
 Light colour/type White
 Required components:

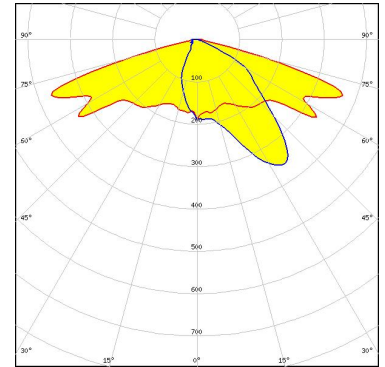

Light distribution files



LED NVSxE21A
 FWHM / FWTM Asymmetric
 Efficiency 82 %
 Peak intensity 0.7 cd/lm
 LEDs/each optic 1
 Light colour/type White
 Required components:

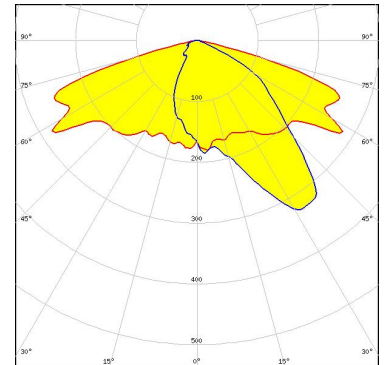

Protective plate, glass

Light distribution files



LED NVSxx19B/NVSxx19C
 FWHM / FWTM Asymmetric
 Efficiency 94 %
 Peak intensity 0.9 cd/lm
 LEDs/each optic 1
 Light colour/type White
 Required components:

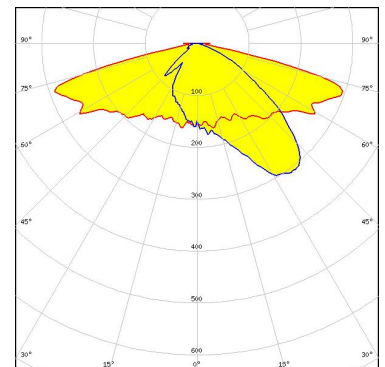

Light distribution files

OPTICAL RESULTS (SIMULATED):

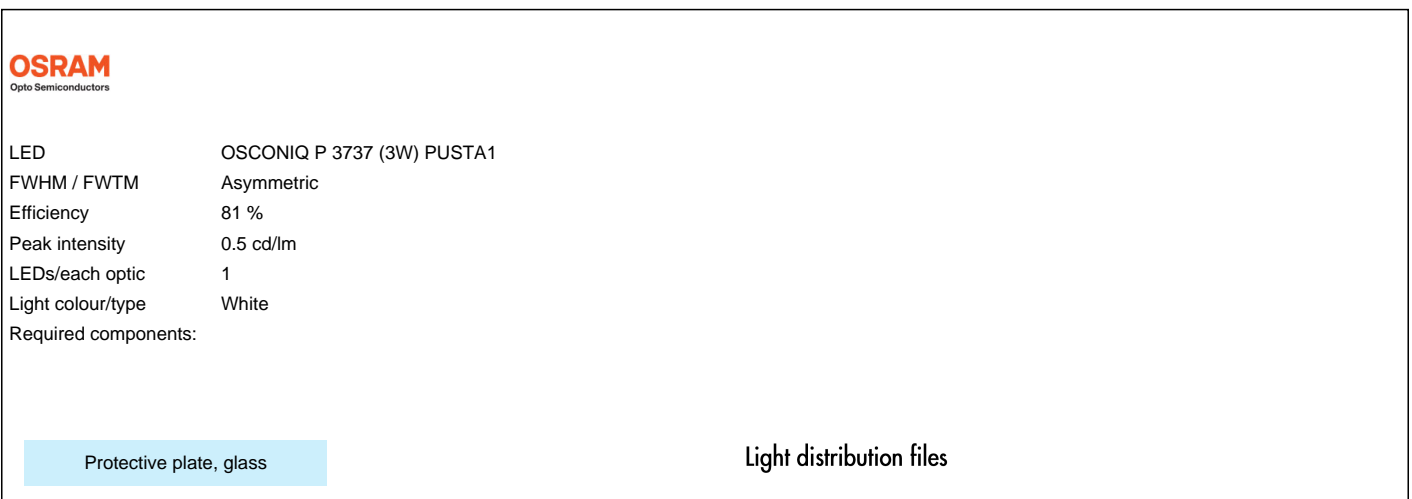
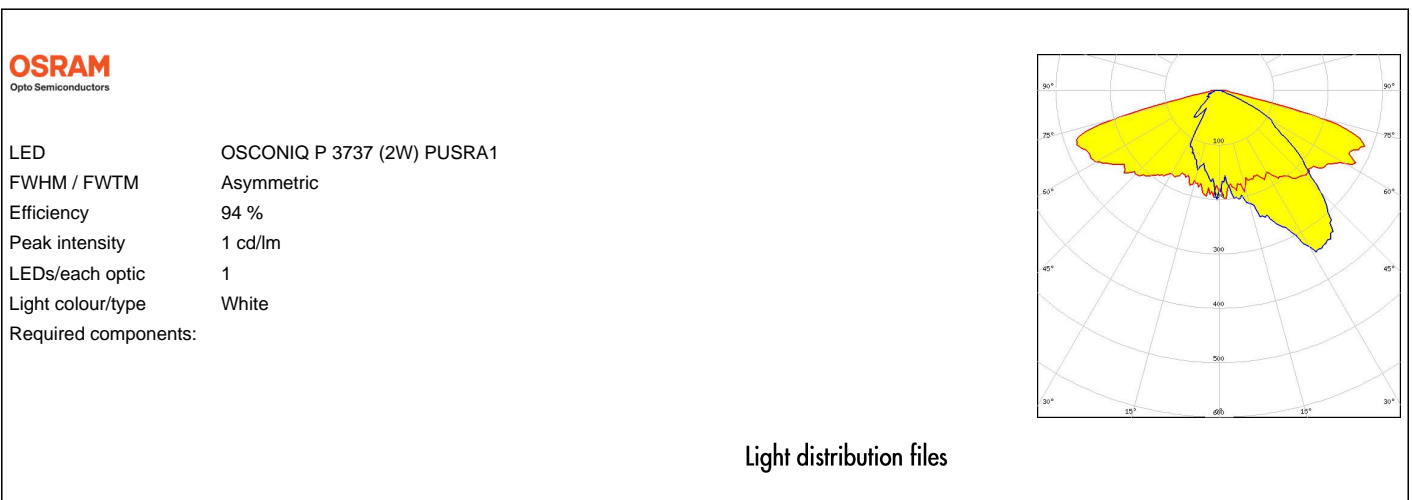
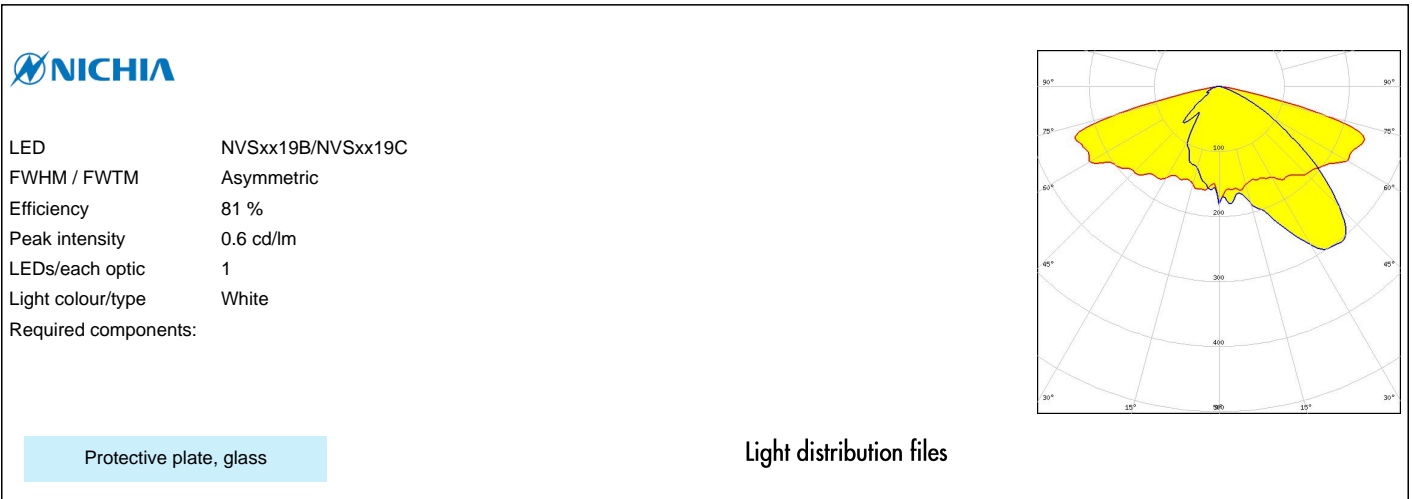

OPTICAL RESULTS (SIMULATED):

OSRAM
Opto Semiconductors

LED OSCONIQ P 3737 (3W) PUSTA1
 FWHM / FWTM Asymmetric
 Efficiency 94 %
 Peak intensity 0.6 cd/lm
 LEDs/each optic 1
 Light colour/type White
 Required components:

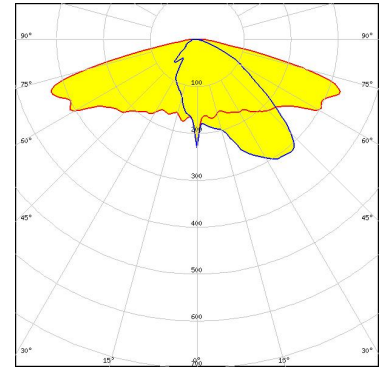

Light distribution files

OSRAM
Opto Semiconductors

LED OSOLON Square CSSRM2/CSSRM3
 FWHM / FWTM Asymmetric
 Efficiency 73 %
 Peak intensity 0.8 cd/lm
 LEDs/each optic 1
 Light colour/type White
 Required components:
 C17677_STRADA-2X2-SHD-BLK

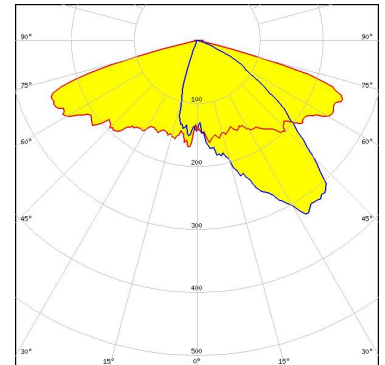

Light distribution files

OSRAM
Opto Semiconductors

LED OSOLON Square CSSRM2/CSSRM3
 FWHM / FWTM Asymmetric
 Efficiency 79 %
 Peak intensity 0.5 cd/lm
 LEDs/each optic 1
 Light colour/type White
 Required components:

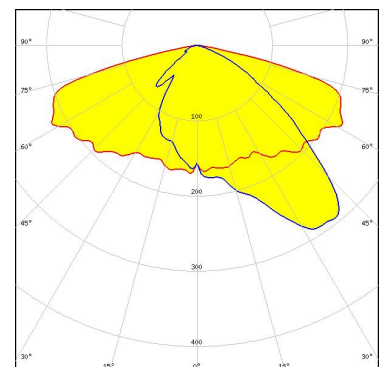

Protective plate, glass

Light distribution files

OPTICAL RESULTS (SIMULATED):

OSRAM
Opto Semiconductors

LED OSLO[®]N Square CSSRM2/CSSRM3
 FWHM / FWTM Asymmetric
 Efficiency 92 %
 Peak intensity 0.9 cd/lm
 LEDs/each optic 1
 Light colour/type White
 Required components:

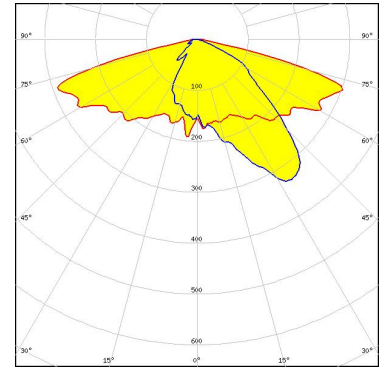

Light distribution files

OSRAM
Opto Semiconductors

LED OSLO[®]N Square CSSRM2/CSSRM3
 FWHM / FWTM Asymmetric
 Efficiency 64 %
 Peak intensity 0.5 cd/lm
 LEDs/each optic 1
 Light colour/type White
 Required components:
 C17677_STRADA-2X2-SHD-BLK

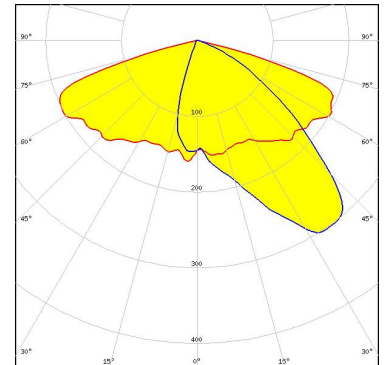

Light distribution files

Protective plate, glass

OSRAM
Opto Semiconductors

LED OSLO[®]N Square CSSRM2/CSSRM3
 FWHM / FWTM Asymmetric
 Efficiency 79 %
 Peak intensity 0.8 cd/lm
 LEDs/each optic 1
 Light colour/type White
 Required components:
 C17580_STRADA-2X2-SHD-WHT

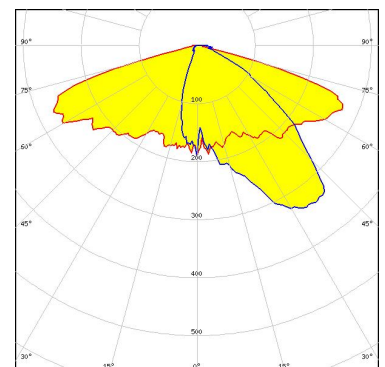

Light distribution files

OPTICAL RESULTS (SIMULATED):

OSRAM
Opto Semiconductors

LED OSLON Square CSSRM2/CSSRM3
 FWHM / FWTM Asymmetric
 Efficiency 69 %
 Peak intensity 0.5 cd/lm
 LEDs/each optic 1
 Light colour/type White
 Required components:
 C17580_STRADA-2X2-SHD-WHT

Protective plate, glass

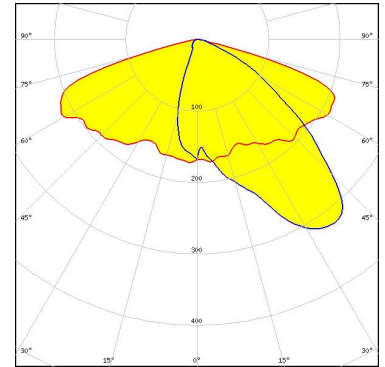

Light distribution files

OSRAM
Opto Semiconductors

LED OSLON Square CSSRM2/CSSRM3
 FWHM / FWTM Asymmetric
 Efficiency 82 %
 Peak intensity 0.6 cd/lm
 LEDs/each optic 1
 Light colour/type White
 Required components:

Protective plate, glass

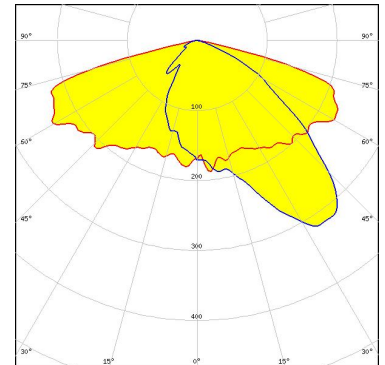

Light distribution files

PHILIPS

LED Fortimo FastFlex LED 2x8 DA (U)HE
 FWHM / FWTM Asymmetric
 Efficiency 83 %
 Peak intensity 0.4 cd/lm
 LEDs/each optic 1
 Light colour/type White
 Required components:

Protective plate, glass

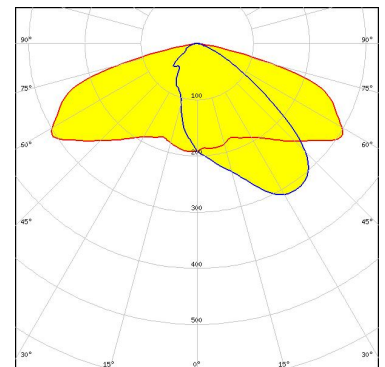

Light distribution files

OPTICAL RESULTS (SIMULATED):

PHILIPS

LED	Fortimo FastFlex LED 2x8 DA (U)HE
FWHM / FWTM	Asymmetric
Efficiency	97 %
Peak intensity	0.5 cd/lm
LEDs/each optic	1
Light colour/type	White
Required components:	

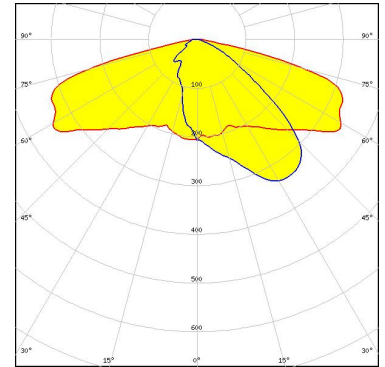

Light distribution files

PHILIPS

LED	Fortimo FastFlex LED 2x8 DA G5
FWHM / FWTM	Asymmetric
Efficiency	83 %
Peak intensity	0.5 cd/lm
LEDs/each optic	1
Light colour/type	White
Required components:	

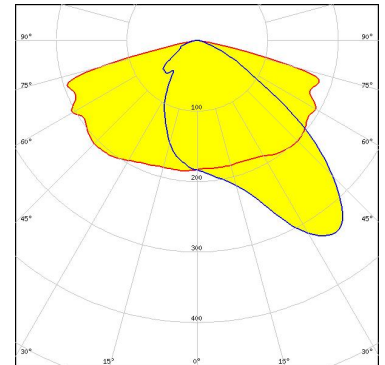

Light distribution files

Protective plate, glass

SAMSUNG

LED	HiLOM RH12 Z (LH351C)
FWHM / FWTM	Asymmetric
Efficiency	82 %
Peak intensity	0.6 cd/lm
LEDs/each optic	1
Light colour/type	White
Required components:	

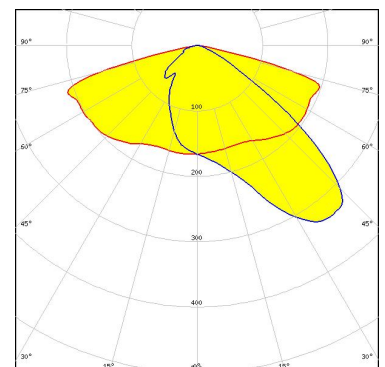

Light distribution files

Protective plate, glass

OPTICAL RESULTS (SIMULATED):

SAMSUNG

LED LH231B
 FWHM / FWTM Asymmetric
 Efficiency 94 %
 Peak intensity 0.8 cd/lm
 LEDs/each optic 1
 Light colour/type White
 Required components:

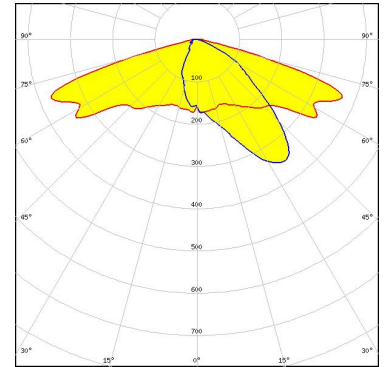

Light distribution files

SAMSUNG

LED LH351C
 FWHM / FWTM Asymmetric
 Efficiency 71 %
 Peak intensity 0.5 cd/lm
 LEDs/each optic 1
 Light colour/type White
 Required components:
 C17580_STRADA-2X2-SHD-WHT

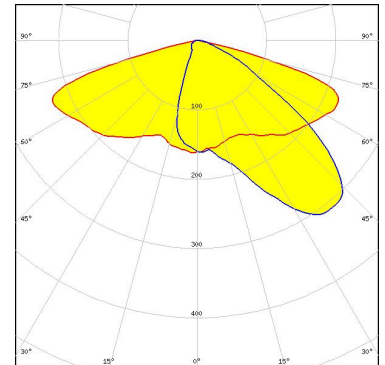

Light distribution files

Protective plate, glass

SAMSUNG

LED LH351C
 FWHM / FWTM Asymmetric
 Efficiency 64 %
 Peak intensity 0.5 cd/lm
 LEDs/each optic 1
 Light colour/type White
 Required components:
 C17677_STRADA-2X2-SHD-BLK

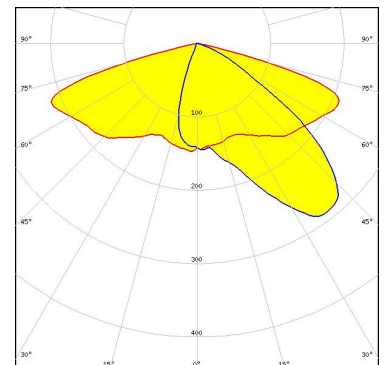

Light distribution files

Protective plate, glass

OPTICAL RESULTS (SIMULATED):

SAMSUNG

LED LH351D
FWHM / FWTM Asymmetric
Efficiency 75 %
Peak intensity 0.4 cd/lm
LEDs/each optic 1
Light colour/type White
Required components:

Protective plate, glass

Light distribution files

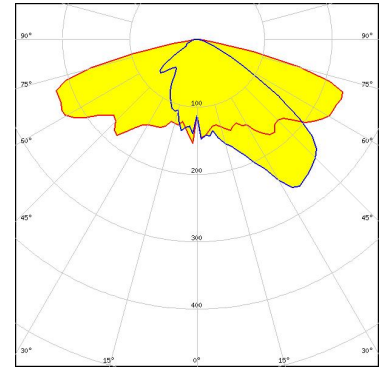

LED Z5M3
FWHM / FWTM Asymmetric
Efficiency 80 %
Peak intensity 0.5 cd/lm
LEDs/each optic 1
Light colour/type White
Required components:

Protective plate, glass

Light distribution files

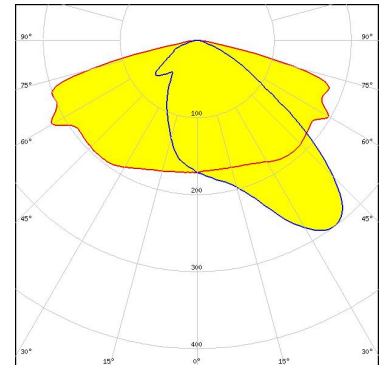

LED Z5M3-E1
FWHM / FWTM Asymmetric
Efficiency 83 %
Peak intensity 0.5 cd/lm
LEDs/each optic 1
Light colour/type White
Required components:

Protective plate, glass

Light distribution files

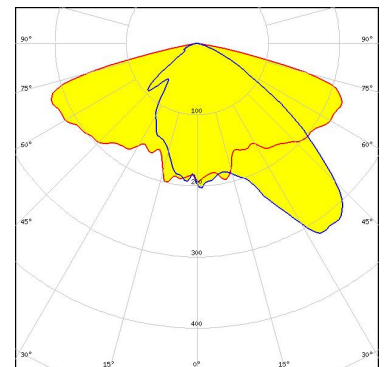

OPTICAL RESULTS (SIMULATED):

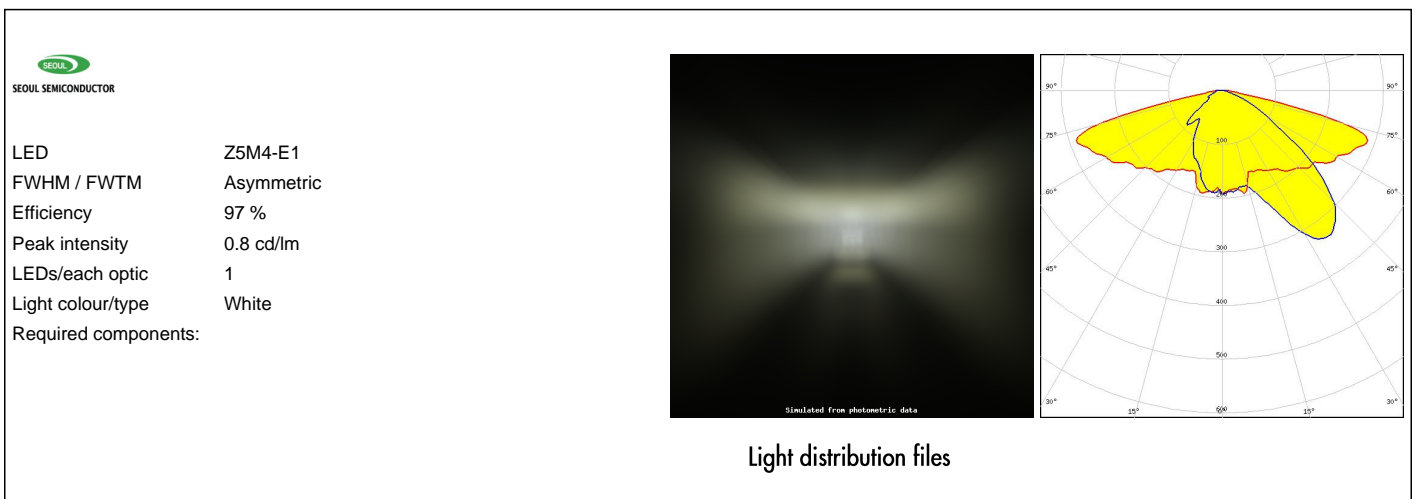
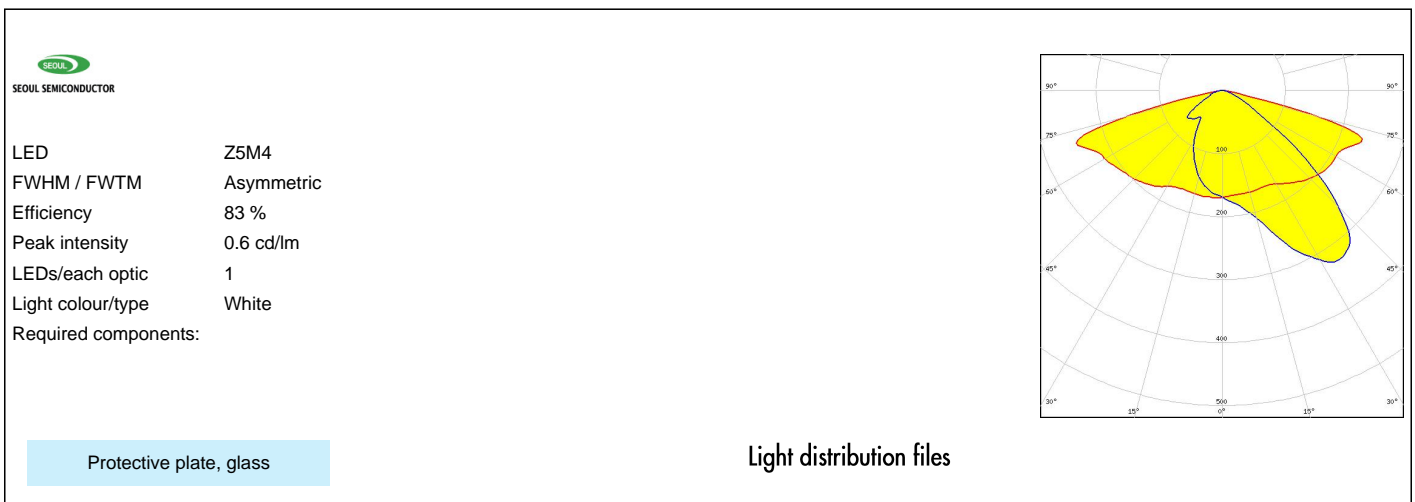
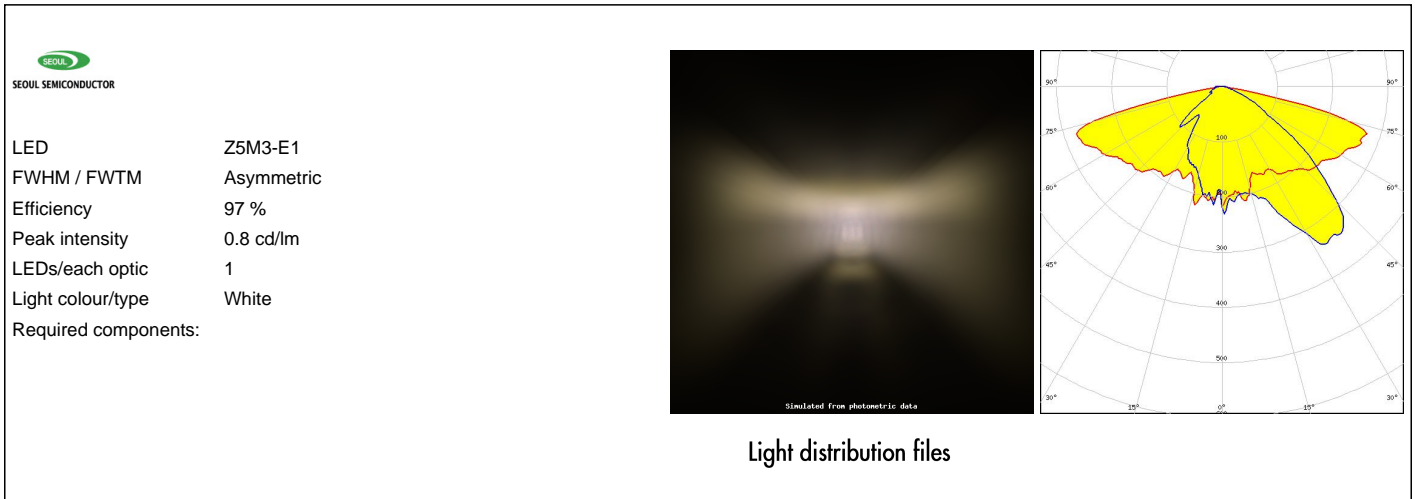

OPTICAL RESULTS (SIMULATED):

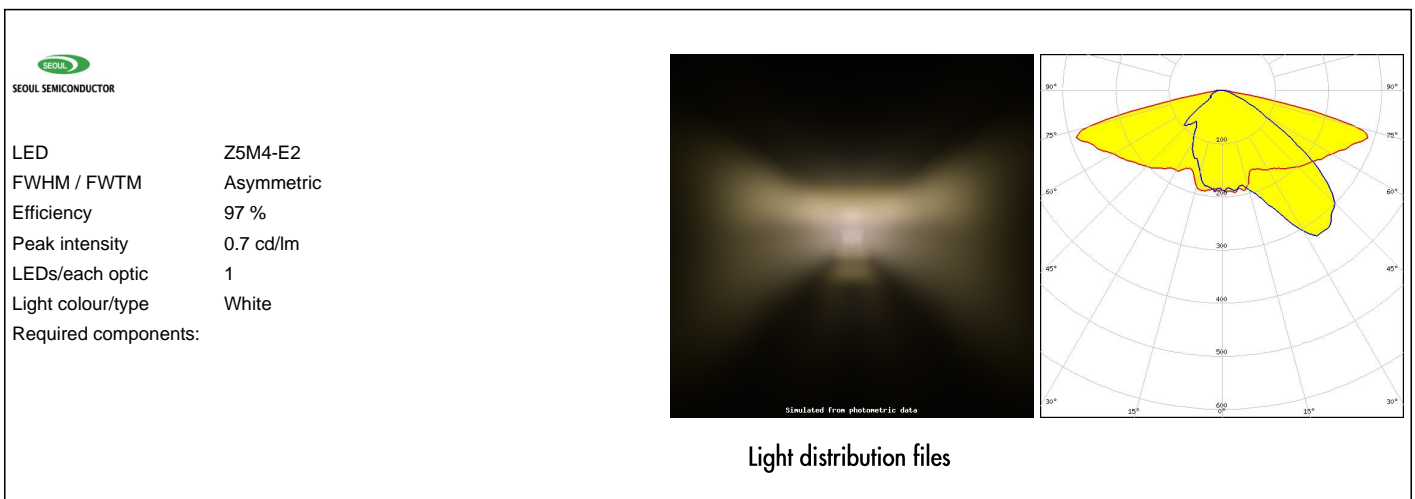
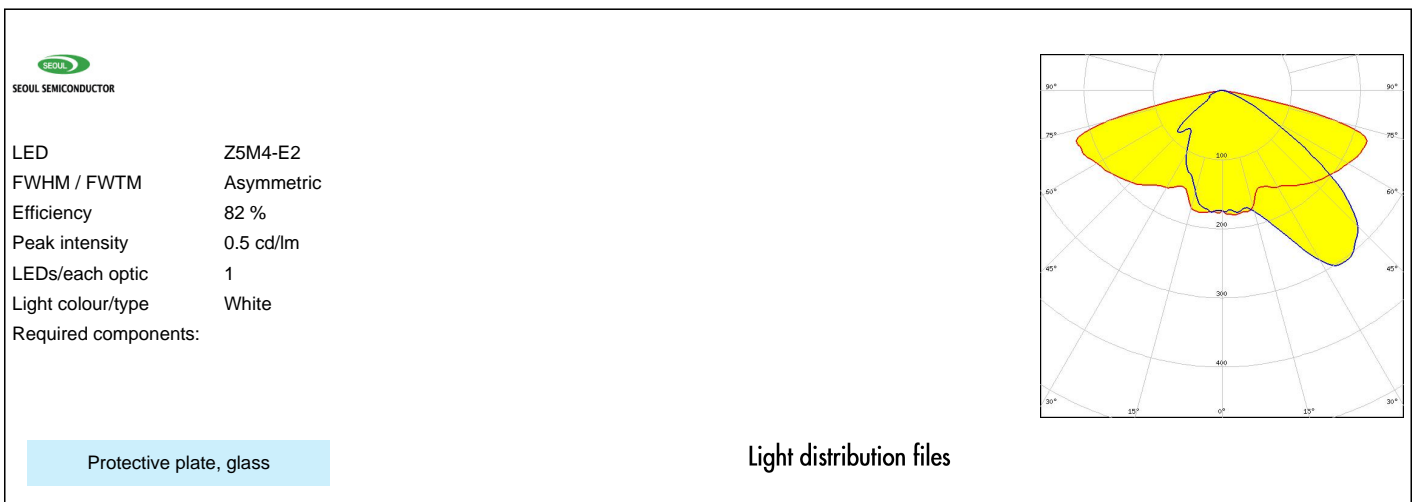
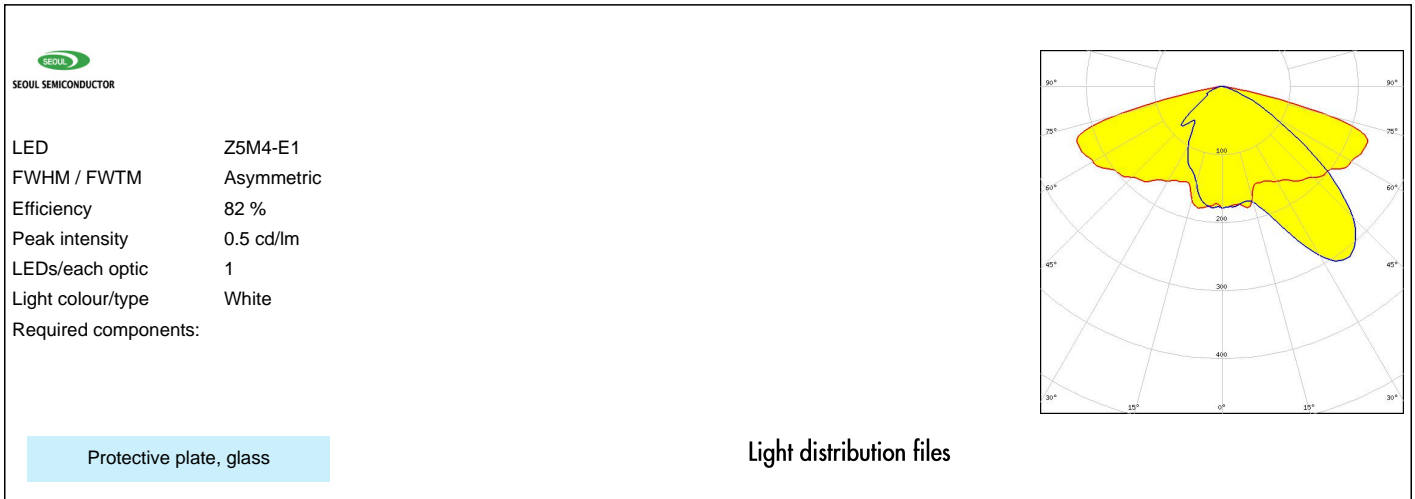

OPTICAL RESULTS (SIMULATED):

TRIDONIC

LED RLE 2x8 4000lm HP EXC2 OTD
FWHM / FWTM Asymmetric
Efficiency 76 %
Peak intensity 0.6 cd/lm
LEDs/each optic 1
Light colour/type White
Required components:
C17677_STRADA-2X2-SHD-BLK

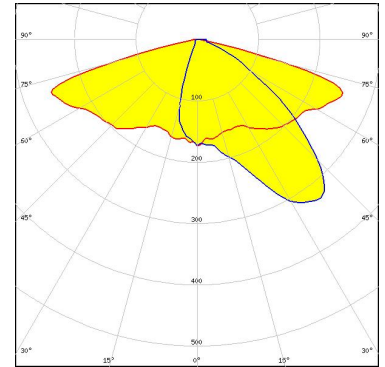

Light distribution files

TRIDONIC

LED RLE 2x8 4000lm HP EXC2 OTD
FWHM / FWTM Asymmetric
Efficiency 84 %
Peak intensity 0.6 cd/lm
LEDs/each optic 1
Light colour/type White
Required components:

Protective plate, glass

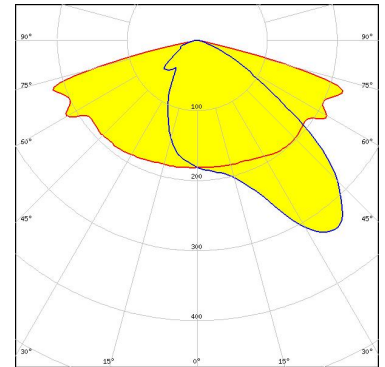

Light distribution files

GENERAL INFORMATION:

NOTE: The typical beam angle will be changed by different color, chip size and chip position tolerance. The typical total beam angle is the full angle measured where the luminous intensity is half of the peak value.

MATERIALS:

As part of our continuous research and improvement processes, and to ensure the best possible quality and availability of our products, LEDiL reserves the right to change material grades without notice.

PRODUCT DATA USER AGREEMENT AND DISCLAIMER:

The measured data in the provided downloadable LEDiL Product Datasheets and Mechanical 2D-Drawings is rounded and provided as reference for planning. LEDiL Oy's optical specifications have been verified by conducting performance testing of the products in accordance with the company's quality system. The reported data are averaged results of multiple measurements with typical variation. LEDiL Oy reserves the right to without prior notification make changes and improvements to its products.

LEDiL Oy assumes neither warranty, nor guarantee nor any other liability of any kind for the contents and correctness of the provided data. The provided data has been generated with highest diligence but the provided data may in reality not represent the complete possible variation range of all intrinsic parameters. Therefore, in certain cases a deviation from the provided data could occur.

LEDiL Oy reserves the right to undertake technical changes of its products without further notification which could lead to changes in the provided data. LEDiL Oy assumes no liability of any kind for the possible deviation from any provided data or any other damage resulting from the usage of the provided data.

The user agrees to this disclaimer and user agreement with the download or usage of the provided files.

LEDiL Oy

Joensuunkatu 7
FI-24100 SALO
Finland

LEDiL Inc.

228 West Page Street
Suite D
Sycamore IL 60178
USA

Ledil Optics Technology (Shenzhen) Co., Ltd.

405 , Block B
Casic Motor Building
Shenzhen 518057
P.R.CHINA

Local sales and technical support

[www.ledil.com/
where_to_buy](http://www.ledil.com/where_to_buy)

Shipping locations

Poznan, Poland
Hong Kong, China

Distribution Partners

[www.ledil.com/
where_to_buy](http://www.ledil.com/where_to_buy)