

Diode Module

50A Avg 800 Volts

PT50SN8

■回路図 CIRCUIT

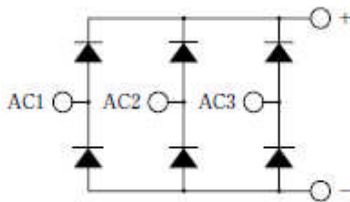

■外形寸法図 OUTLINE DRAWING

Dimension: [mm]

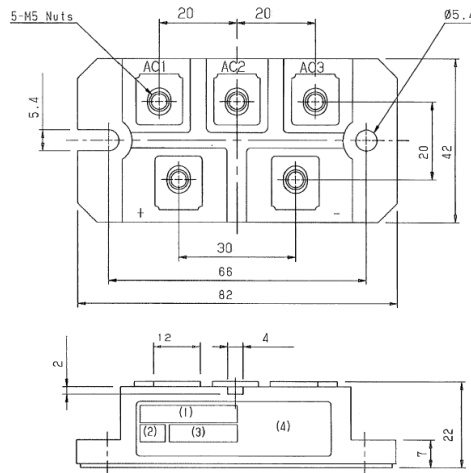

■最大定格 Maximum Ratings

項目 Parameter	記号 Symbol	耐圧クラス Grade		単位 Unit
		PT50SN8		
くり返しピーク逆電圧 Repetitive Peak Reverse Voltage	*1 V _{RRM}	800		V
非くり返しピーク逆電圧 Non Repetitive Peak Reverse Voltage	*1 V _{RSM}	900		V

項目 Parameter	記号 Symbol	条件 Conditions	定格値 Max. Rated Value	単位 Unit		
平均出力電流 Average Rectified Output Current	I _{O(AV)}	三相全波整流 3-Phase Full Wave, Rectified T _c =T _t =125°C (t: Terminal)	50	A		
サージ順電流 Surge Forward Current	*1 I _{FSM}	50Hz 正弦半波, 1サージ, 非くり返し Half Sine Wave, 1Pulse, Non-Repetitive	450	A		
電流二乗時間積 I Squared t	*1 I ² t	2~10ms	1000	A ² s		
動作接合温度範囲 Operating Junction Temperature Range	T _{jw}		-40 ~ +150	°C		
保存温度範囲 Storage Temperature Range	T _{stg}		-40 ~ +125	°C		
絶縁耐圧 Isolation Voltage	V _{iso}	端子-ベース間, AC 1分間 Terminal to Base, AC 1min.	2500	V		
締付トルク Mounting Torque	ベース部 Mounting	F	サマロンパウト [®] 塗布 Greased	M5	2.4 ~ 2.8	N・m
	主端子部 Terminal		M5	2.4 ~ 2.8	N・m	

■電気的特性 Electrical Characteristics

項目 Parameter	記号 Symbol	条件 Conditions	特性値 (最大) Maximum Value	単位 Unit
ピーク逆電流 Peak Reverse Current	*1 I _{RM}	T _j =150°C, V _{RM} =V _{RRM}	1	mA
ピーク順電圧 Peak Forward Voltage	*1 V _{FM}	T _j =25°C, I _{FM} =50A	1.19	V
熱抵抗 Thermal Resistance	R _{th(j-c)}	接合部-ケース間 (トータル) Junction to Case, (Total)	0.11	°CW
接触熱抵抗 Thermal Resistance	R _{th(c-f)}	ケースフィン間 (トータル), サマロンパウト [®] 塗布 Case to Fin (Total), Greased	0.06	°CW

質量 --- 約 180g
Approximate Weight

*1: 1アーム当りの値 Value Per 1 Arm

順電压特性
FORWARD CURRENT VS. VOLTAGE

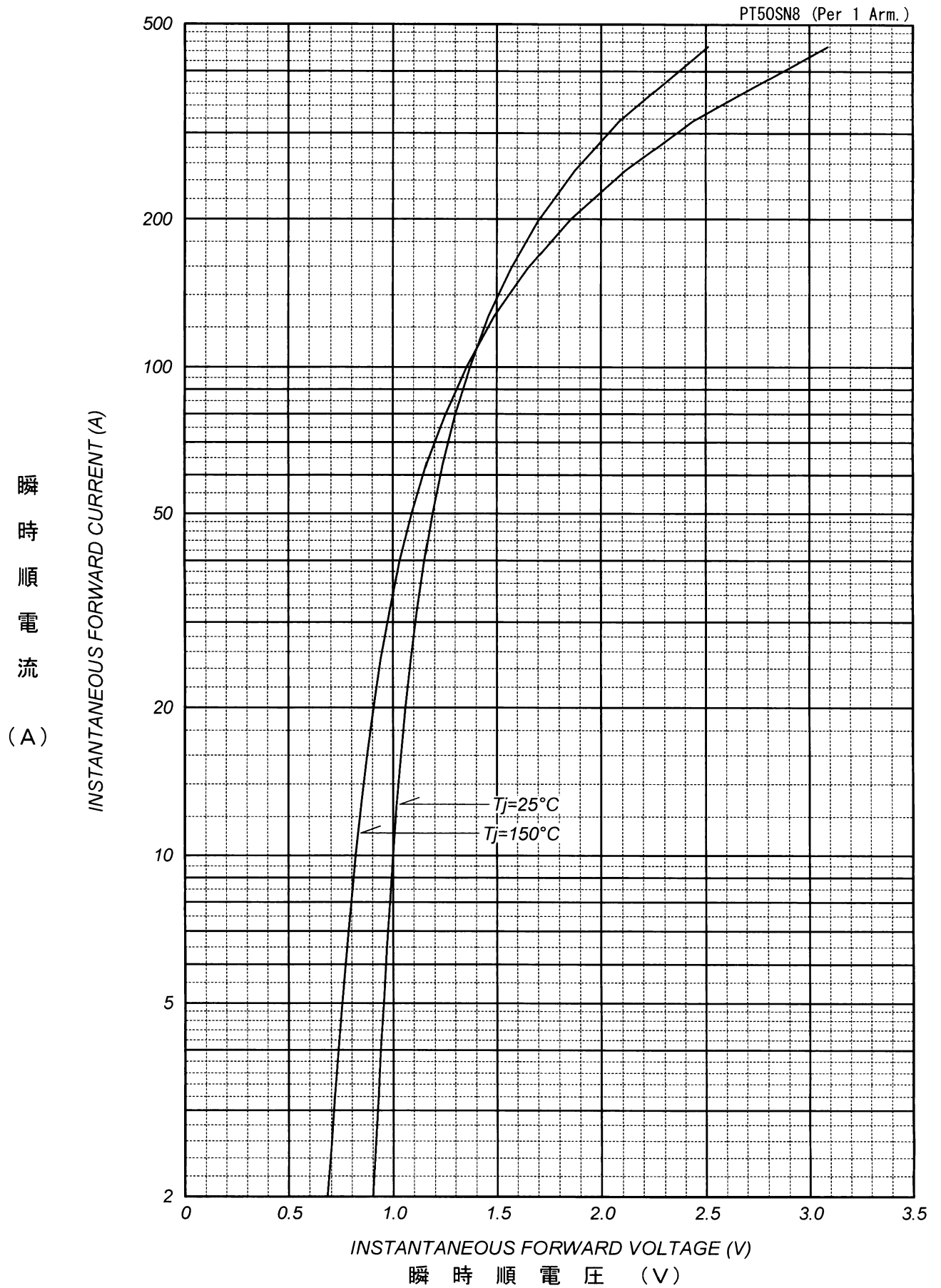

平均順電力損失特性
AVERAGE FORWARD POWER DISSIPATION

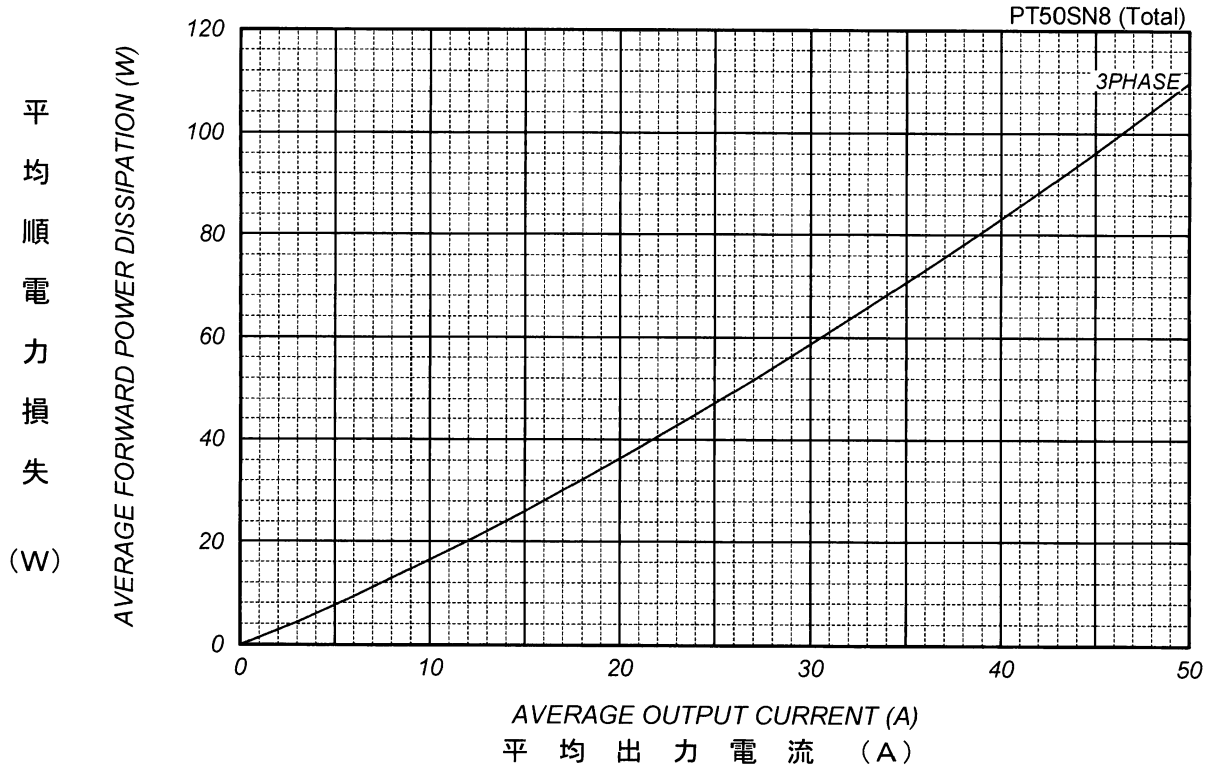

平均出力電流 - ケース温度定格
AVERAGE OUTPUT CURRENT VS. CASE TEMPERATURE

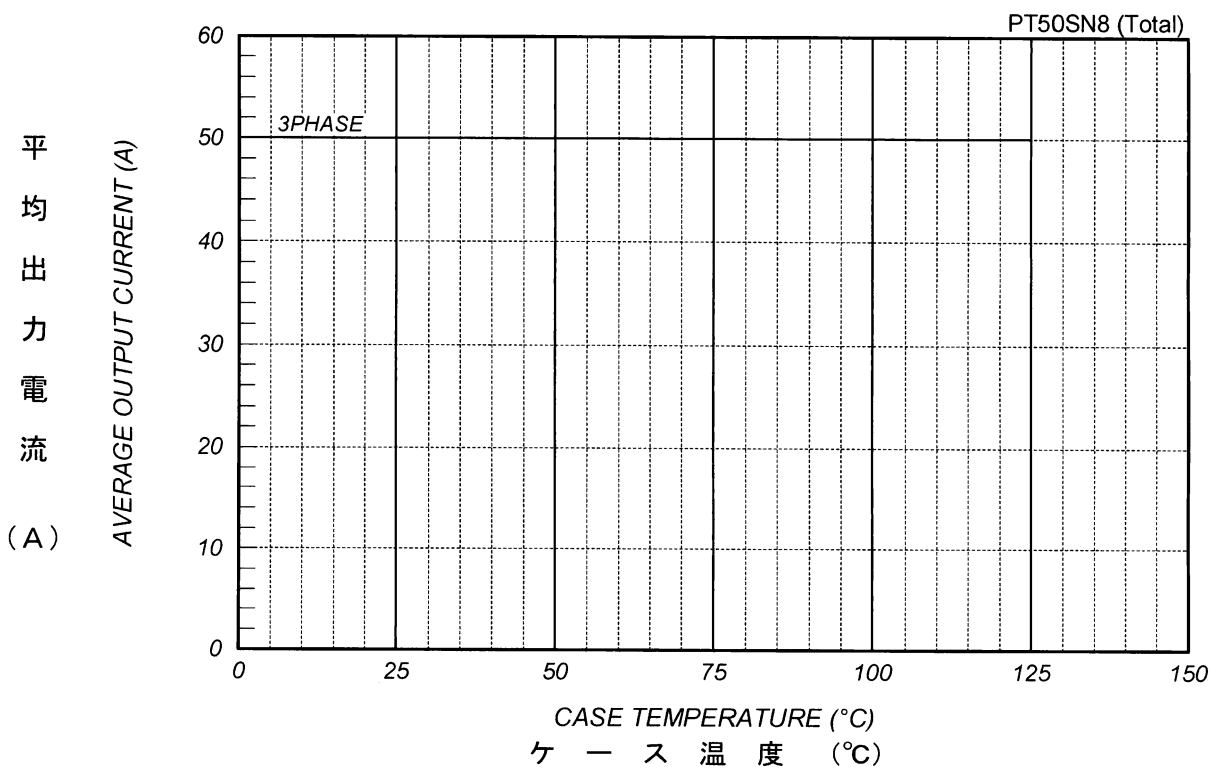

サージ順電流定格
SURGE CURRENT RATINGS

f=50Hz, Half Sine Wave, Non-Repetitive, Tj=150°C

PT50SN8 (Per 1 Arm.)

サージ順電流 (A)

SURGE FORWARD CURRENT (A)

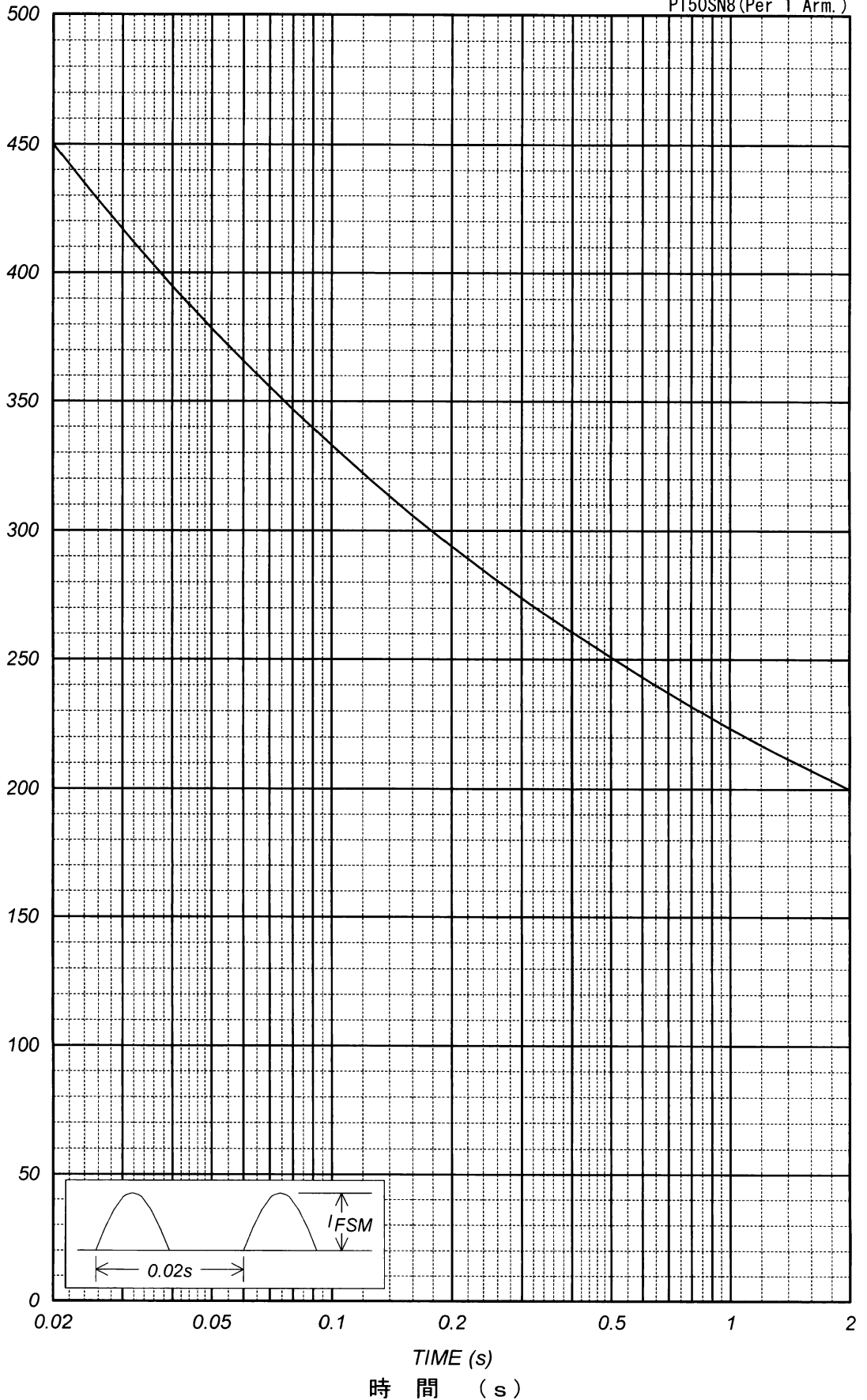

過渡熱抵抗特性
Transient Thermal Impedance

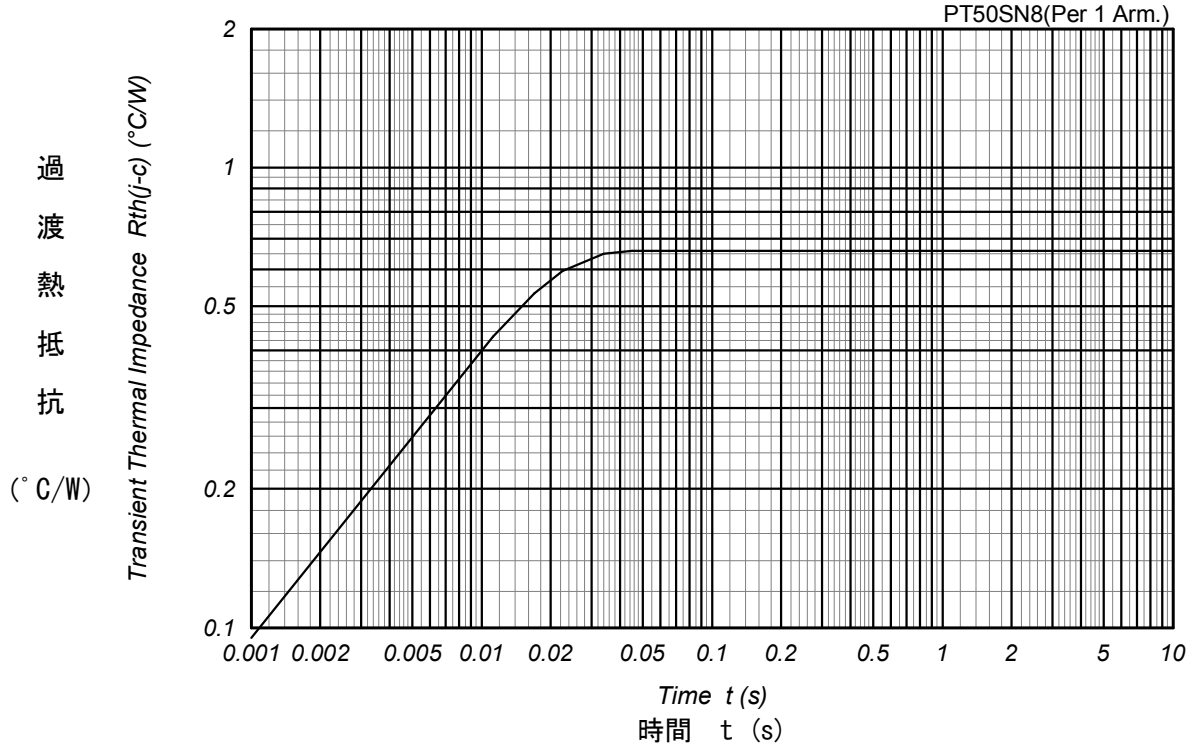

1. ご採用に際しては、別途仕様書をご請求の上、ご確認をお願いいたします。
If you wish to use any such product, please be sure to refer to the specifications issued by Shindengen.
2. 本資料に記載されている当社製品の品質水準は、一般的な信頼度が要求される標準用途を意図しています。その製品の故障や誤動作が直接生命や人体に影響を及ぼすような極めて高い品質、信頼度を要求される特別、特定用途の機器、装置にご使用の場合には必ず事前に当社へご連絡の上、確認を得てください。当社の製品の品質水準は以下のように分類しております。
All products described or contained herein are designed with a quality level intended for use in standard applications requiring an ordinary level of reliability. If these products are to be used in equipment or devices for special or specific applications requiring an extremely high grade of quality or reliability in which failures or malfunctions of products may directly affect human life or health, a local Shindengen office must be contacted in advance to confirm that the intended use of the product is appropriate. Shindengen products are grouped into the following three applications according to the quality grade.
【標準用途】
コンピュータ、OA等の事務機器、通信用端末機器、計測器、AV機器、アミューズメント機器、家電、工作機器、パーソナル機器、産業用機器等
【Standard applications】
Computers, office automation and other office equipment, communication terminals, test and measurement equipment, audio/visual equipment, amusement equipment, consumer electronics, machine tools, personal electronic equipment, industrial equipment, etc.
【特別用途】
輸送機器(車載、船舶等)、基幹用通信機器、交通信号機器、防災/防犯機器、各種安全機器、医療機器等
【Special applications】
Transportation equipment (vehicles, ships, etc.), trunk-line communication equipment, traffic signal control systems, anti-disaster/crime systems, safety equipment, medical equipment, etc.
【特定用途】
原子力制御システム、航空機器、航空宇宙機器、海中継ぎ機器、生命維持のための装置、システム等
【Specific applications】
Nuclear reactor control systems, aircraft, aerospace equipment, submarine repeaters, life support equipment and systems, etc.
3. 当社は品質と信頼性の向上に絶えず努めていますが、必要に応じ、安全性を考慮した冗長設計、延焼防止設計、誤動作防止設計等の手段により結果として人身事故、火災事故、社会的な損害等が防止できるようご検討下さい。
Although Shindengen continuously endeavors to enhance the quality and reliability of its products, customers are advised to consider and take safety measures in their design, such as redundancy, fire containment and anti-failure, so that personal injury, fires, or societal damages can be prevented.
4. 本資料に記載されている内容は、製品改良などのためお断りなしに変更することがありますのでご了承下さい。製品のご購入に際しましては事前に当社または特約店へ最新の情報をご確認下さい。
Please note that all information described or contained herein is subject to change without notice due to product upgrades and other reasons. When buying Shindengen products, please contact the Company's offices or distributors to obtain the latest information.
5. 本資料の使用によって起因する損害または特許権その他権利の侵害に関しては、当社は一切その責任を負いません。
Shindengen shall not bear any responsibility with regards to damages or infringement of any third-party patent rights and other intellectual property rights incurred due to the use of information on this website.
6. 本資料によって第三者または当社の特許権その他権利の実施に対する保証または実施権の許諾を行うものではありません。
The information and materials on this website neither warrant the use of Shindengen's or any third party's patent rights and other intellectual property rights, nor grant license to such rights.
7. 本資料に記載されている製品が、外国為替及び外国貿易管理法に基づき規制されている場合、輸出には同法に基づく日本国政府の輸出許可が必要です。
In the event that any product described or contained herein falls under the category of strategic products controlled under the Foreign Exchange and Foreign Trade Control Law of Japan, exporting of such products shall require an export license from the Japanese government in accordance with the above law.
8. 本資料の一部または全部を当社に無断で転載または複製することを堅くお断りいたします。
No reprinting or reproduction of the materials on this website, either in whole or in part, is permitted without proper authorization from Shindengen.