



Reset IC

PST853/PST854 Series

Overview

This IC is a system reset IC that detect turn-off or the power flicker in power supply of CPU or logic systems. The IC has the delay time pin by an external capacitor and separated sense pin. The output don't occur to turn over without minimum operating limit voltage by separated sense and power supply pin. Therefore the IC is suitable for low voltage detection applications.

Features

- Low current consumption
- Separated sense pin

Main specifications

- Absolute maximum rating : -0.3V ~ 6.5V
- Operating voltage : 0.7V ~ 6.0V
- Operating ambient temperature : -40°C ~ 85°C
- Detection voltage : 0.8V ~ 5.2V (0.1V step)
- Detection voltage accuracy : ±1%
- Hysteresis voltage : Typ. $V_{TH} \times 0.05$
- Consumption current : Typ. 0.35uA
- Output type : PST853A: CMOS
PST854A: Open drain
- Output Logic : Active L
- Delay Resistance : Typ. 1MΩ

Packages

- SOT-25A
- SSON-6J

Application

- Reset circuits for microcomputers, CPUs and MPUs
- Reset circuits for logic circuits
- Battery voltage check circuits
- Back-up power supply switching circuits
- Level detection circuits





Model Name

Series name
(A)
(B)
(C)
(D)
(E)

(A)	Output type	3	CMOS
		4	Open drain
(B)	Delay circuit type	A	Resistance 1MΩ
(C)	Reset detection voltage	080	Specify the detection voltage with a three-digit number. Detection voltage is 0.80V to 5.20V (0.10V steps.)
		∟	
		520	
(D)	Package	N	SOT-25A
		R	SSON-6J
(E)	Packing specifications	R	R housing (SOT-25A)
		L	L housing (SSON-6J) / Halogen free

Block Diagram

- PST853A (CMOS output)

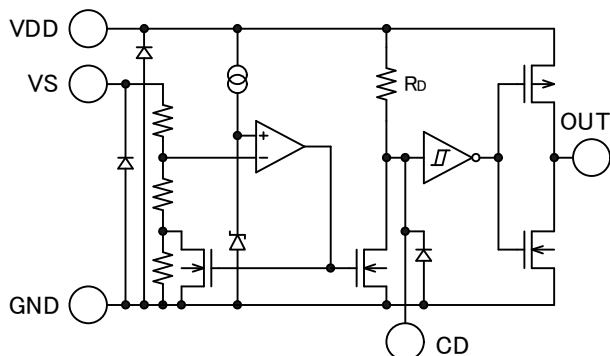

- PST854A (Open drain output)

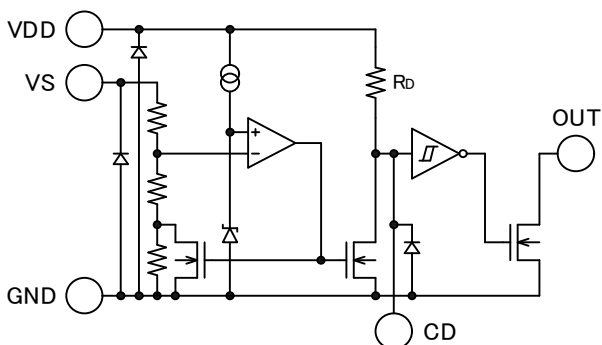



Pin Configuration

■ SOT-25A

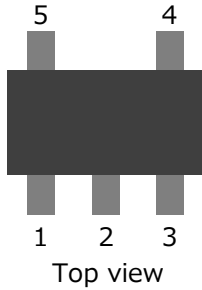

Pin No.	Pin name	Function
1	OUT	Output pin
2	VDD	Power supply input pin
3	GND	Ground pin
4	VS	Sence pin
5	CD	Delay pin with external capacitor

■ SSON-6J

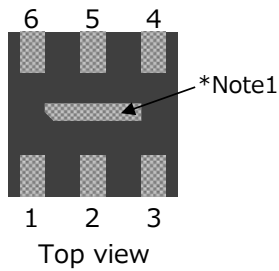

Pin No.	Pin name	Function
1	CD	Delay pin with external capacitor
2	VDD	Power supply input pin
3	VS	Sence pin
4	GND	Ground pin
5	NC	No Connection
6	OUT	Output pin

*Note1: Heat Spreader Bottom with VDD or open.



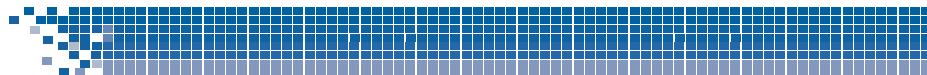

Absolute Maximum Ratings

Item	Symbol	Min.	Max.	Unit	
Supply voltage	VDD	-0.3	6.5	V	
VS pin voltage	VS	-0.3	6.5	V	
CD pin voltage	VCD	-0.3	VDD+0.3	V	
Output voltage	PST853	VOUT	-0.3	VDD+0.3	V
	PST854		-0.3	6.5	V
Output current	IOUT	0	20	mA	
Storage temperature	Tstg	-55	125	°C	

Recommended Operating Conditions

Item	Symbol	Min.	Max.	Unit
Operating Ambient temperature	Topr	-40	85	°C
Operating voltage (VDD)	Vop	0.7	6.0	V



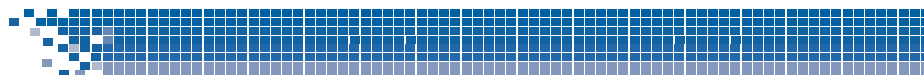

Electrical Characteristics

(Ta=25°C, unless otherwise specified) *Note2

Item	Symbol	Conditions	Min.	Typ.	Max.	Unit	Test circuit	
Reset voltage *Note2	VTH	VDD=VTH+1V VS=H→L Upper line Ta=25°C Lower line Ta=-40°C~85°C	0.8V	0.780 0.776	0.800 -	0.820 0.824	V	①
			0.9V	0.880 0.873	0.900 -	0.920 0.927		
			1.0V	0.980 0.970	1.000 -	1.020 1.030		
			1.1V	1.080 1.067	1.100 -	1.120 1.133		
			1.2V	1.180 1.164	1.200 -	1.220 1.236		
			1.3V	1.280 1.261	1.300 -	1.320 1.339		
			1.4V	1.380 1.358	1.400 -	1.420 1.442		
			1.5V	1.480 1.455	1.500 -	1.520 1.545		
			1.6V	1.580 1.552	1.600 -	1.620 1.648		
			1.7V	1.680 1.649	1.700 -	1.720 1.751		
			1.8V	1.780 1.746	1.800 -	1.820 1.854		
			1.9V	1.880 1.843	1.900 -	1.920 1.957		
			2.0V	1.980 1.940	2.000 -	2.020 2.060		
			2.1V	2.079 2.037	2.100 -	2.121 2.163		
			2.2V	2.178 2.134	2.200 -	2.222 2.266		
			2.3V	2.277 2.231	2.300 -	2.323 2.369		
			2.4V	2.376 2.328	2.400 -	2.424 2.472		
			2.5V	2.475 2.425	2.500 -	2.525 2.575		
			2.6V	2.574 2.522	2.600 -	2.626 2.678		
			2.7V	2.673 2.619	2.700 -	2.727 2.781		
2.8V	2.772 2.716	2.800 -	2.828 2.884					
2.9V	2.871 2.813	2.900 -	2.929 2.987					
3.0V	2.970 2.910	3.000 -	3.030 3.090					





Electrical Characteristics

(Ta=25°C, unless otherwise specified) *Note2

Item	Symbol	Conditions	Min.	Typ.	Max.	Unit	Test circuit	
Reset voltage *Note2	VTH	VDD=VTH+1V VS=H→L Upper line Ta=25°C Lower line Ta=-40°C~85°C	3.1V	3.069 3.007	3.100 -	3.131 3.193	V	①
			3.2V	3.168 3.104	3.200 -	3.232 3.296		
			3.3V	3.267 3.201	3.300 -	3.333 3.399		
			3.4V	3.366 3.298	3.400 -	3.434 3.502		
			3.5V	3.465 3.395	3.500 -	3.535 3.605		
			3.6V	3.564 3.492	3.600 -	3.636 3.708		
			3.7V	3.663 3.589	3.700 -	3.737 3.811		
			3.8V	3.762 3.686	3.800 -	3.838 3.914		
			3.9V	3.861 3.783	3.900 -	3.939 4.017		
			4.0V	3.960 3.880	4.000 -	4.040 4.120		
			4.1V	4.059 3.977	4.100 -	4.141 4.223		
			4.2V	4.158 4.074	4.200 -	4.242 4.326		
			4.3V	4.257 4.171	4.300 -	4.343 4.429		
			4.4V	4.356 4.268	4.400 -	4.444 4.532		
			4.5V	4.455 4.365	4.500 -	4.545 4.635		
			4.6V	4.554 4.462	4.600 -	4.646 4.738		
			4.7V	4.653 4.559	4.700 -	4.747 4.841		
			4.8V	4.752 4.656	4.800 -	4.848 4.944		
			4.9V	4.851 4.753	4.900 -	4.949 5.047		
			5.0V	4.950 4.850	5.000 -	5.050 5.150		
5.1V	5.049 4.947	5.100 -	5.151 5.253					
5.2V	5.148 5.044	5.200 -	5.252 5.356					





Electrical Characteristics

(Ta=25°C, unless otherwise specified) *Note2

Item	Symbol	Conditions	Min.	Typ.	Max.	Unit	Test circuit	
Hysteresis voltage	ΔV_{TH}	VDD=VTH+1V VS=0V→VTH+1V→0V	0.8V	0.024	0.040	0.064	V	①
			0.9V	0.027	0.045	0.072		
			1.0V	0.030	0.050	0.080		
			1.1V	0.033	0.055	0.088		
			1.2V	0.360	0.600	0.960		
			1.3V	0.039	0.065	0.104		
			1.4V	0.042	0.070	0.112		
			1.5V	0.045	0.075	0.120		
			1.6V	0.048	0.080	0.128		
			1.7V	0.051	0.085	0.136		
			1.8V	0.054	0.090	0.144		
			1.9V	0.057	0.095	0.152		
			2.0V	0.060	0.100	0.160		
			2.1V	0.063	0.105	0.168		
			2.2V	0.066	0.110	0.176		
			2.3V	0.069	0.115	0.184		
			2.4V	0.072	0.120	0.192		
			2.5V	0.075	0.125	0.200		
			2.6V	0.078	0.130	0.208		
			2.7V	0.081	0.135	0.216		
			2.8V	0.084	0.140	0.224		
			2.9V	0.087	0.145	0.232		
			3.0V	0.090	0.150	0.240		
			3.1V	0.093	0.155	0.248		
			3.2V	0.096	0.160	0.256		
			3.3V	0.099	0.165	0.264		
3.4V	0.102	0.170	0.272					
3.5V	0.105	0.175	0.280					
3.6V	0.108	0.180	0.288					
3.7V	0.111	0.185	0.296					
3.8V	0.114	0.190	0.304					
3.9V	0.117	0.195	0.312					
4.0V	0.120	0.200	0.320					
4.1V	0.123	0.205	0.328					
4.2V	0.126	0.210	0.336					
4.3V	0.129	0.215	0.344					
4.4V	0.132	0.220	0.352					
4.5V	0.135	0.225	0.360					
4.6V	0.138	0.230	0.368					
4.7V	0.141	0.235	0.376					
4.8V	0.144	0.240	0.384					
4.9V	0.147	0.245	0.392					
5.0V	0.150	0.250	0.400					
5.1V	0.153	0.255	0.408					
5.2V	0.156	0.260	0.416					



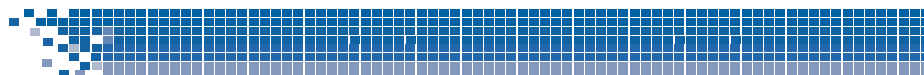

Electrical Characteristics

(Ta=25°C, unless otherwise specified) *Note2

Item	Symbol	Conditions	Min.	Typ.	Max.	Unit	Test circuit
Consumption current	IDD	VDD=VTH+1V VS=VTH+1V	0.8V~ 5.2V	-	0.35	1.0	uA ②
Reset threshold temperature coefficient *Note3	ΔVTH/°C	Ta=-40°C~+85°C	0.8V~ 5.2V	-	±100	-	ppm/°C ①
"L" Transfer delay time *Note3	tPHL	VDD=VTH+0.4V VS=VTH+0.4V→VTH-0.4V	1.2V~ 5.2V	2	15	100	us ③
"H" Transfer delay time *Note3	tPLH	VDD=VTH+0.4V VS=VTH-0.4V→VTH+0.4V	1.2V~ 5.2V	2	15	100	us ③
"L" Output current	IOL1	VDD=VS=0.7V, VDS=0.05V	0.8V~ 5.2V	0.01	0.10	-	mA ④
	IOL2	VDD=VS=1.2V, VDS=0.5V	1.3V~ 5.2V	0.23	2.00	-	
	IOL3	VDD=VS=2.4V, VDS=0.5V	2.5V~ 5.2V	1.60	8.00	-	
	IOL4	VDD=VS=3.6V, VDS=0.5V	3.7V~ 5.2V	3.20	12.0	-	
"H" Output current	IOH1	VDD=VS=4.8V, VDS=0.5V PST853 only	0.8V~ 4.7V	0.36	0.62	-	mA ④
	IOH2	VDD=VS=6.0V, VDS=0.5V PST853 only	0.8V~ 5.2V	0.46	0.75	-	
Output leakage current	Ileak	VDD=6V, VOUT=6V PST854 only	0.8V~ 5.2V	-	-	0.1	uA ④
Delay resistance	RCD	VDD=VS=VTH+1V VCD=0V	0.8V~ 5.2V	0.5	1.0	2.0	MΩ ⑤
CD pin threshold voltage	VTCD	VDD=VS=VTH×1.1 VCD=0V→VDD	0.8V~ 5.2V	VDD×0.3	VDD×0.5	VDD×0.7	V ⑥
CD pin output current 1	ICD1	VDD=VS=0.7V VCD=0.1V	0.8V~ 5.2V	2	30	-	uA ⑤
CD pin output current 2	ICD2	VDD=VS=0.8V VCD=0.5V	0.8V~ 1.0V	20	80	-	uA ⑤
		VDD=VS=1.0V VCD=0.5V	1.1V~ 1.5V	50	150	-	uA ⑤
		VDD=VS=1.5V VCD=0.5V	1.6V~ 5.2V	200	400	-	uA ⑤
VS Input current	RVS	VDD=VTH+1V VS=VHT+1V	0.8V~ 5.2V	-	15	-	MΩ ②

*Note2: The IC is only tested at Ta=25°C in final test. It is guaranteed by design except Ta=25°C.

*Note3: The parameter is guaranteed by design.





Test Circuit

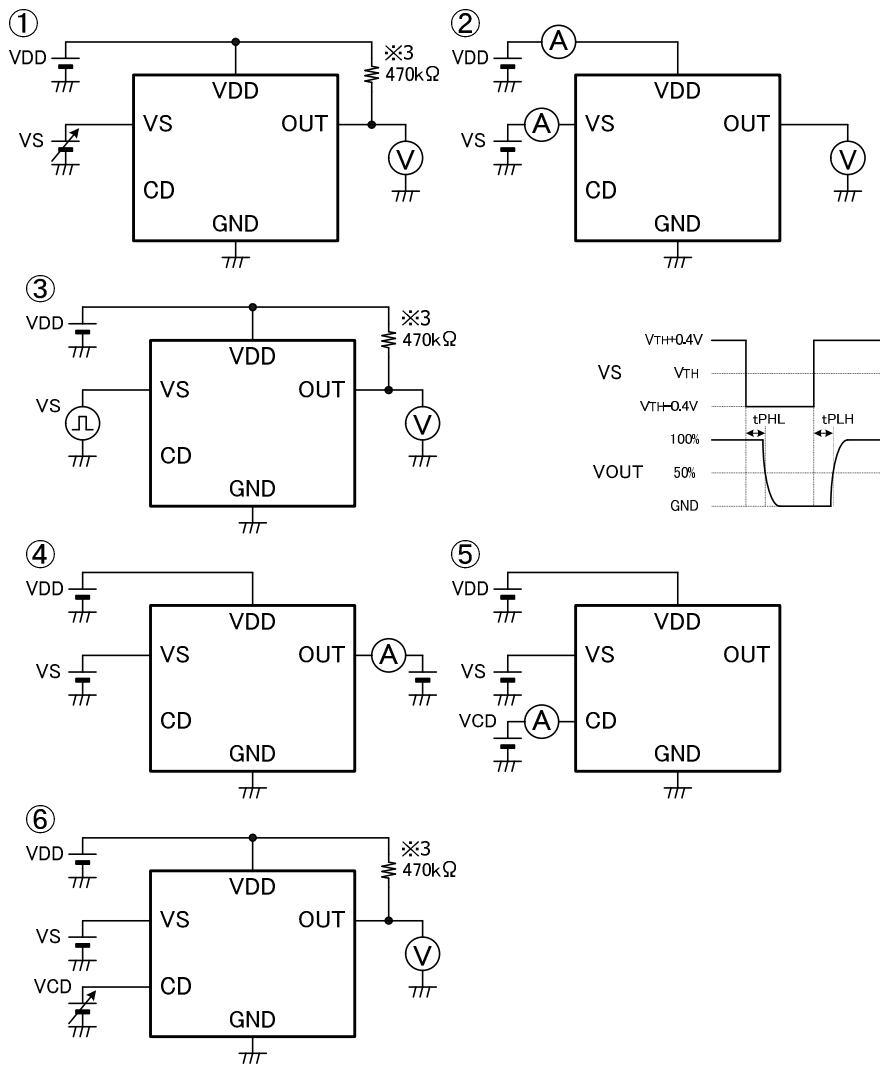

*3 PST854 only





Timing Chart

- PST854A (Open drain output)

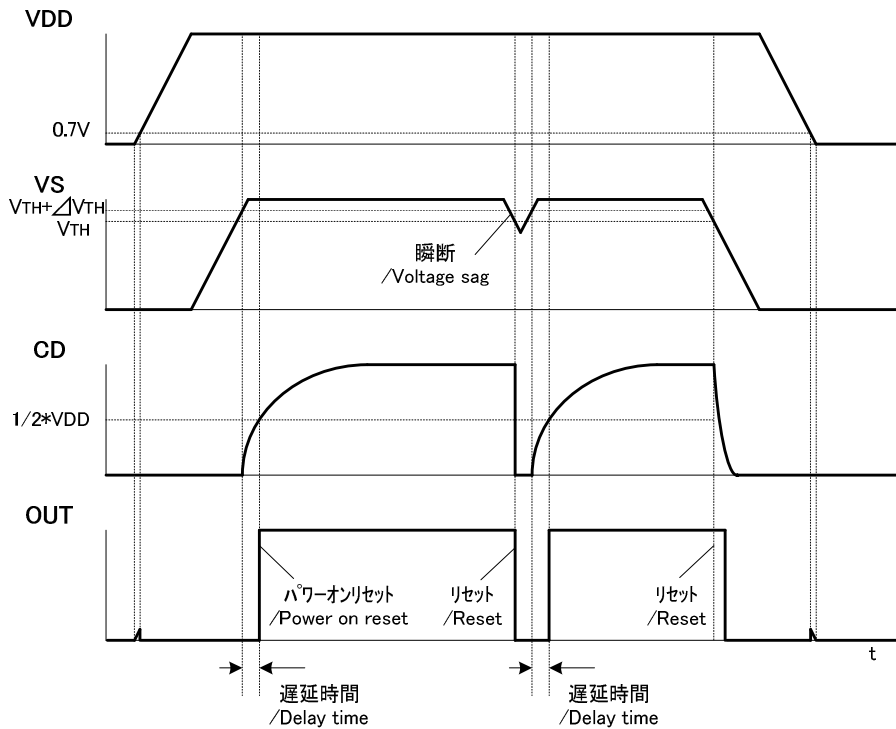

Application Circuit

- PST853

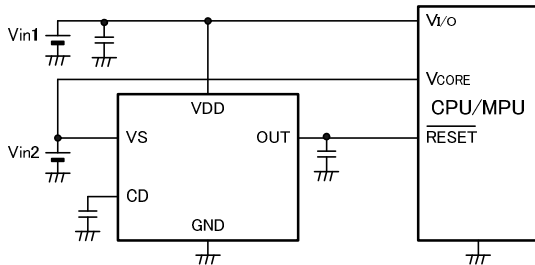

- PST854

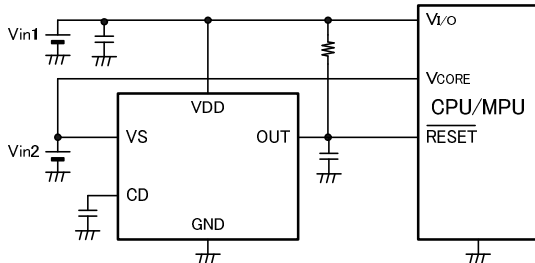

- The typical application circuit is not guaranteed for a set applications. It has to test sufficiently in a set applications.
- In the event a problem which may affect industrial property or any other rights of us or a third party is encountered during the use of information described in these circuit, Mitsumi shall not be liable for any such problem, nor grant a license therefore.





Application notes

- Reset voltage**
 In case of $V_S=H \rightarrow L$, the reset voltage is the detected voltage at $OUT=H \rightarrow L$.
- Release voltage**
 In case of $V_S=L \rightarrow H$, the release voltage is the detected voltage at $OUT=L \rightarrow H$.
 (Release voltage = Reset voltage + Hysteresis voltage)
- Hysteresis voltage**
 The hysteresis voltage prevents a malfunction from power supply noise.
 (Hysteresis voltage = Release voltage - Reset voltage)

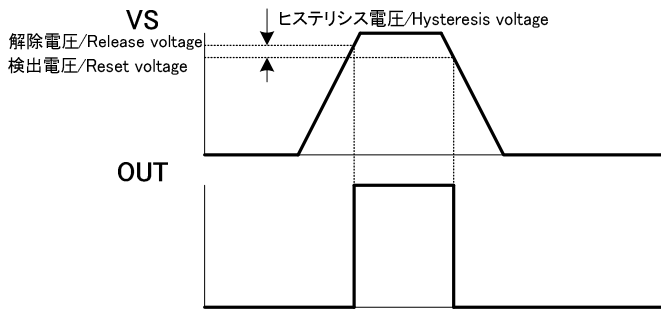

- VS pin**
 The VS pin is sense pin is separated from VDD. It does not have the minimum operating voltage, because VDD is supplied by another bias. Therefore the function is suitable to low voltage reset applications.

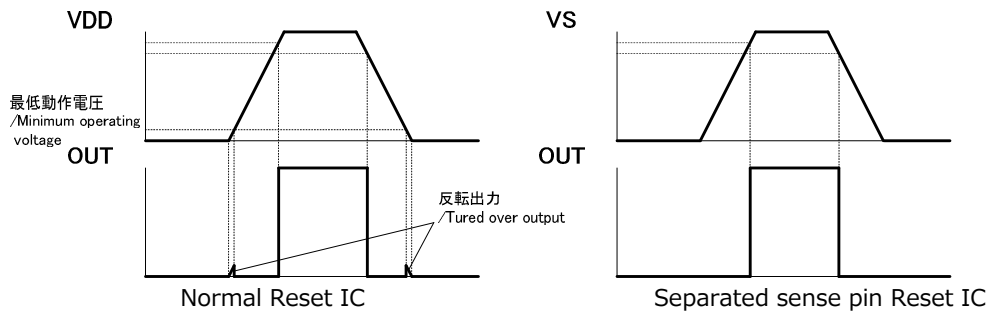

- VDD pin**
 VDD pin is bias of internal circuit. When VDD is sharp fluctuated, a malfunction may occur in the IC. It is recommended to use for VDD a stable power supply.
- Supply voltage sequence**
 The turning on supply voltage sequence is $VDD \rightarrow VS$, the turning off sequence is $VS \rightarrow VDD$.
- VDD to VS short circuit**
 VS pin can use to connect with VDD pin. But an input resistance can not be inserted on an input line as below. (It is possible to oscillate by through-current of VDD.)
 And then OUT pin is occurred to turn over less than the minimum operating voltage of VDD.

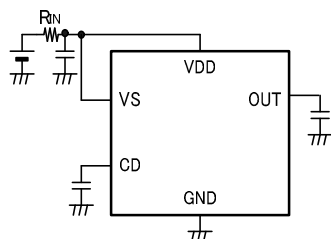



Application notes

Reset voltage of external setting

Reset voltage can be set by external resistances. Reset voltage VS' is as below.

RA and RB is set to consider an error of IVS.

$$VS' = (1 + (RA/RB)) \times VS + RA \times IVS$$

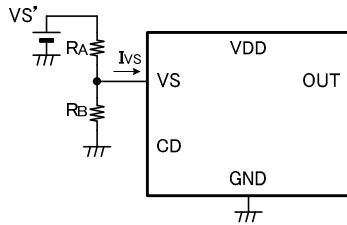

Delay time

The delay circuit is connected with an external capacitor to CD pin.

The delay time is decided on time constant by an internal resistance and an external capacitor.

Power-on-reset (VS=L→H) is released, after an input voltage turned on stable voltage.

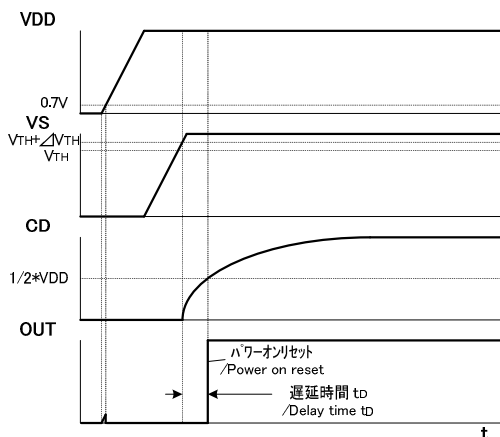

Delay Time

$$tD = 0.69 \times CD \times RD \text{ [s]}$$

CD: External capacitor [F]

RD: Delay resistance [Ω]

The charging time formula of the CR time constant, is a case of " $V_{CD} = 0.5 \times VDD$ ".

$$tD = -CD \times RD \times \ln(1 - V_{CD}/VDD)$$

V_{CD}: CD threshold voltage [V]

Delay circuit type

Delay circuit type are an internal resistance.

The resistance type is compatible with PST83/84xx and PST893/894A.

CD pin

CD pin is high impedance for a delay resistance or constant current circuit.

It is necessary to take care for dew condensation or PCB or capacitor leakage.

Long delay time

When a high delay capacitor is used, the release delay time can be long.

But a delay time occurs in reset operation by discharge time of capacitor.

A set is recommended to design considering the delay time.





Application notes

- CMOS output
CMOS output is inverter output between VDD and GND. It is not necessary to connect a pull-up resistance.
- Open drain output
Open drain output is certainly connected with an external pull-up resistance.
The pull-up resistance can be supplied for any voltage and more than VDD voltage.
At high temperature, please pay attention to the leak current for open drain NMOS, it happens output voltage is up to leak current.

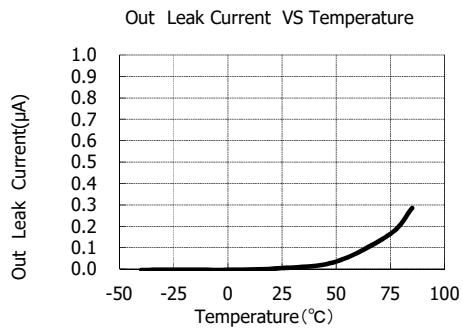

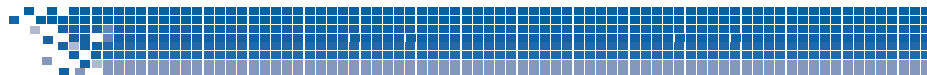

Typical Performance Characteristics (PST854A270)

(Ta=25°C, unless otherwise specified)

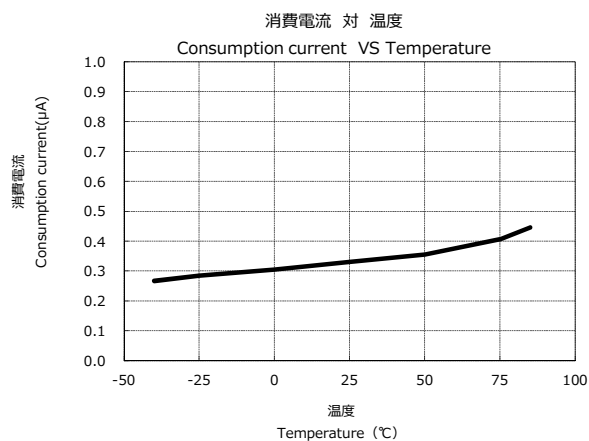
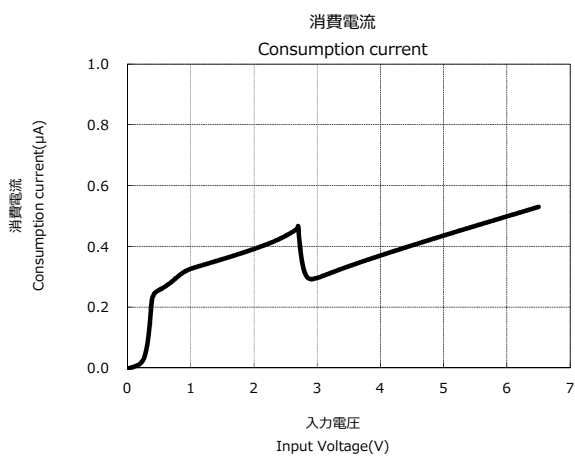
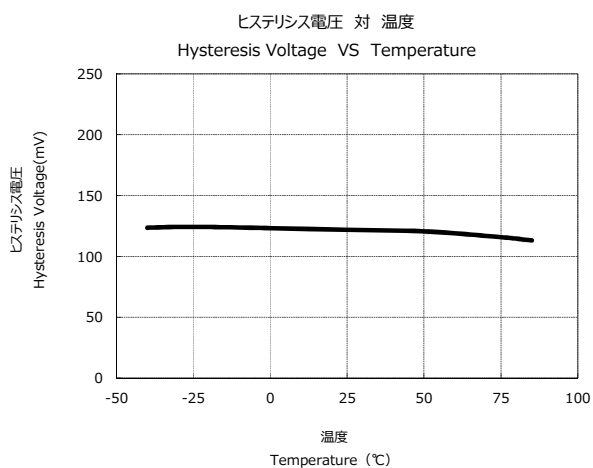
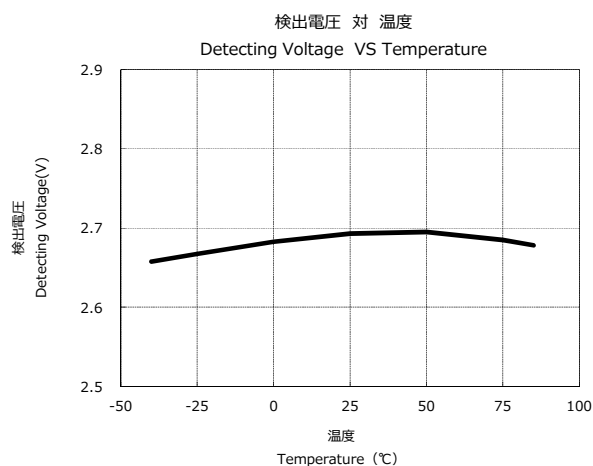
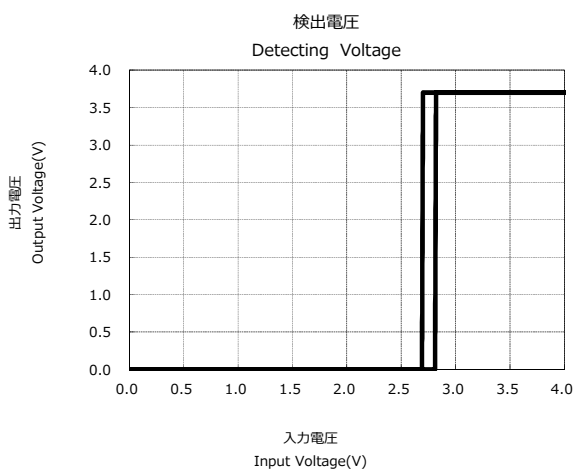



Typical Performance Characteristics (PST854A270)

(Ta=25°C, unless otherwise specified)

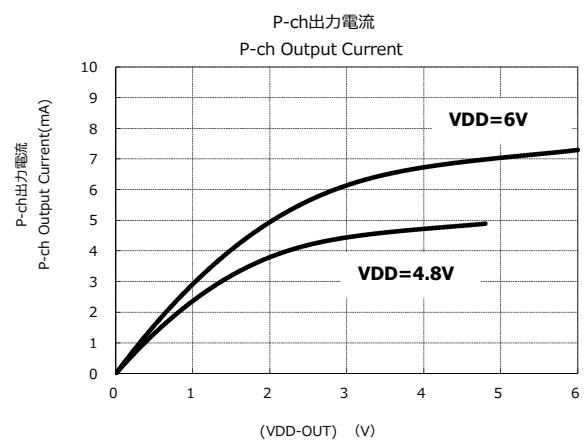
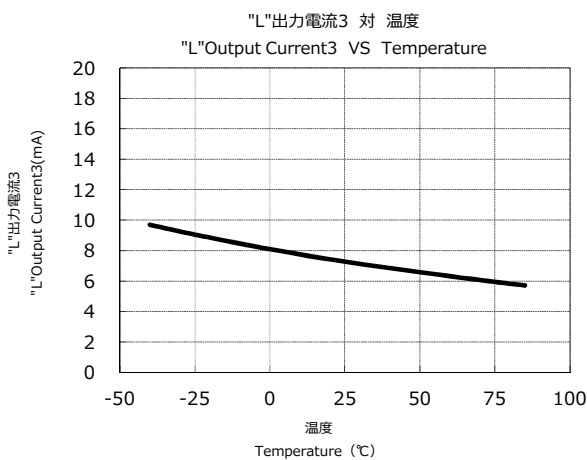
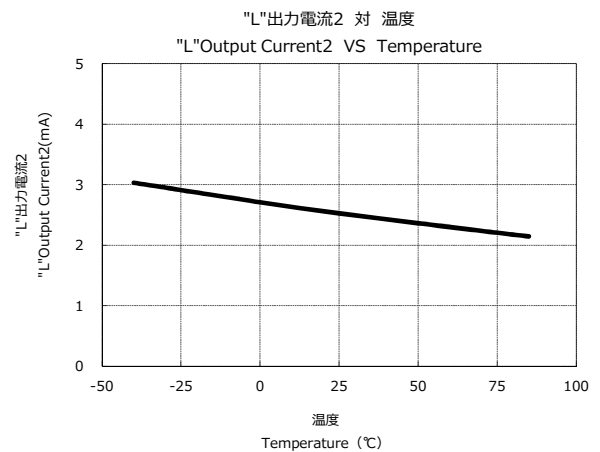
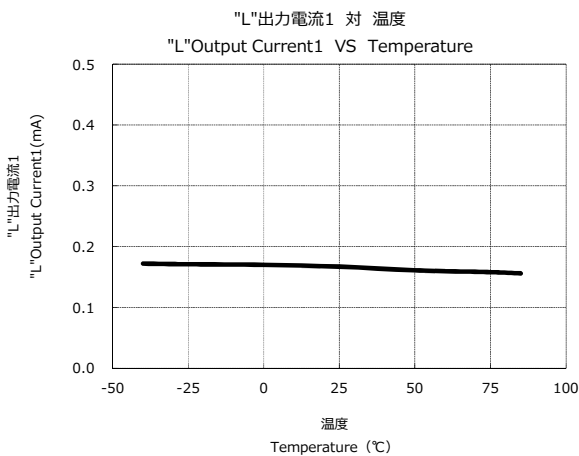
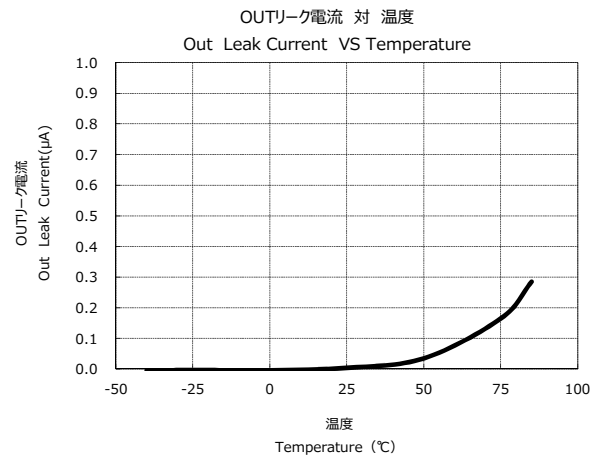
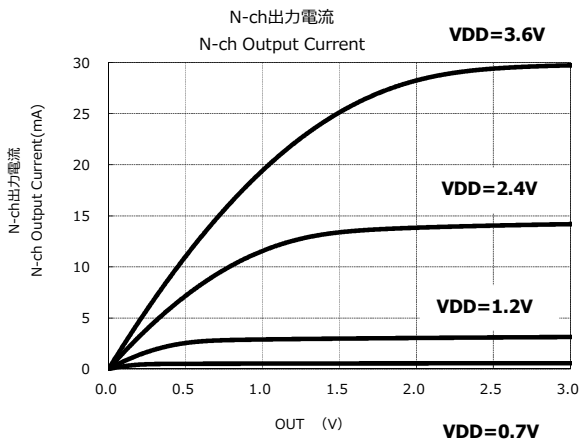



Typical Performance Characteristics (PST854A270)

(Ta=25°C, unless otherwise specified)

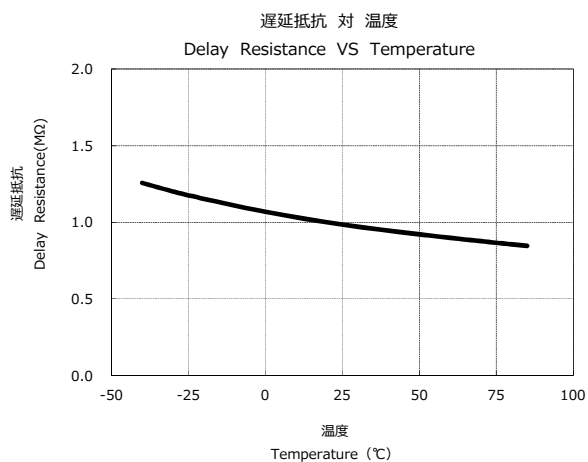
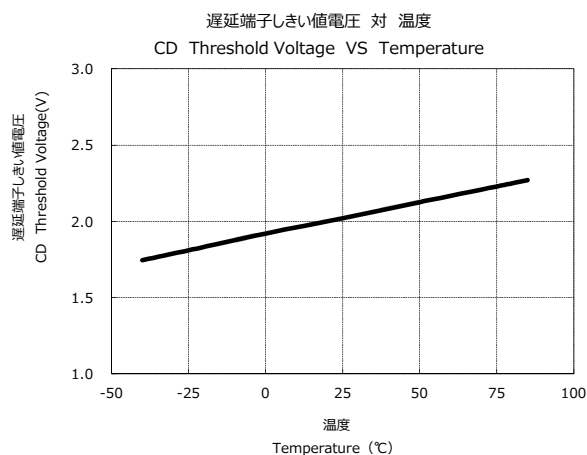
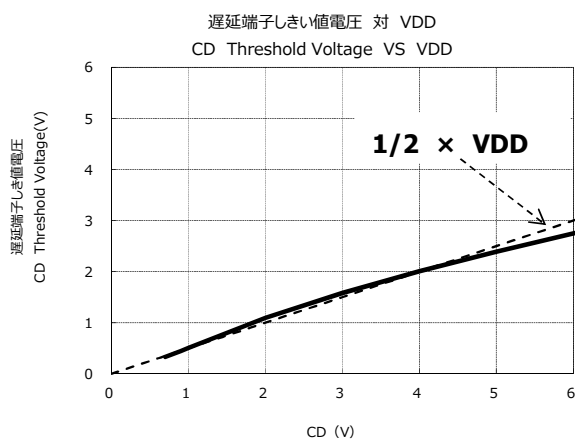
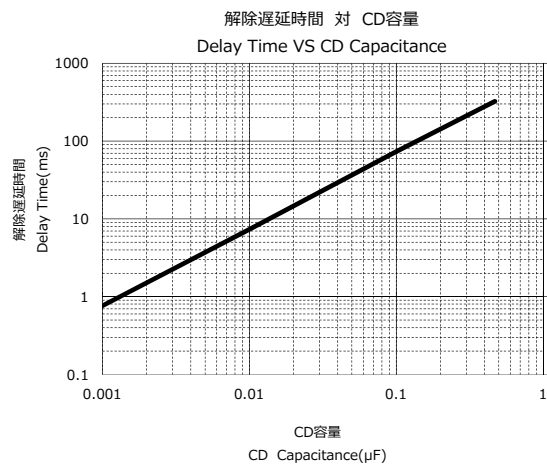
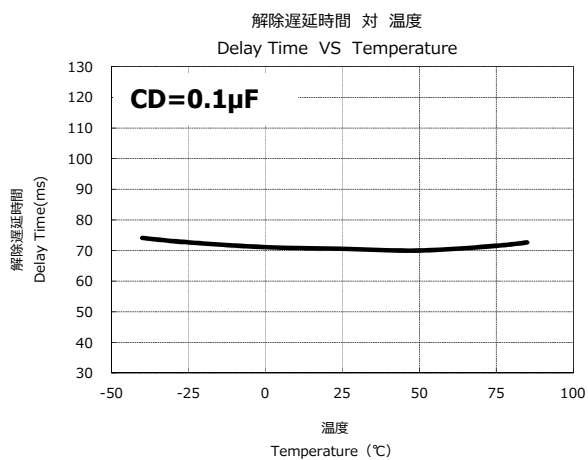



Typical Performance Characteristics (PST854A270)

(Ta=25°C, unless otherwise specified)

