

Data Sheet | Item Number: 769-104

1-conductor female connector; CAGE CLAMP®; 4 mm²; Pin spacing 5 mm; 4-pole; coding finger; 4,00 mm²; gray

<https://www.wago.com/769-104>

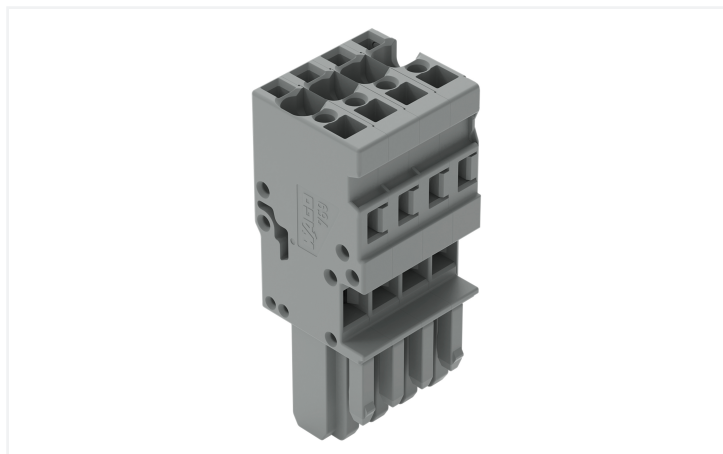

Color: ■ gray



Dimensions in mm

Female connector, 769 Series, gray

Our female connector (item number 769-104) simplifies electrical installations. Strip lengths must be between 8 and 9 mm when connecting conductors to this female connector. Pluggable rail-mount terminal blocks are primarily found in switchgear units and control systems, most notably in railroad technology. These innovative systems combine the properties of rail-mount terminal blocks and connectors for a flexible and reliable wiring system. You also have the option of pre-assembling installations, which not only makes production but also installation, operation, and maintenance more efficient and cost-effective. This product incorporates conductor terminals and utilizes CAGE CLAMP®. Our highly-rated and maintenance-free CAGE CLAMP® connection makes it easy to connect all types of conductors without having to prepare the conductor. For example, you don't need to crimp ferrules. Dimensions: (20 x 45.2 x 18.3) mm (width x height x depth). Depending on the type of conductor, this female connector is ideal for conductor cross sections ranging from 0.08 mm² to 4 mm².

This female connector/socket is operated with an operating tool.

Notes

Safety Information

According to EN 61984, pluggable connectors without current interrupting capacity must not be mated or unmated when live or under load.

Electrical data

Ratings per	IEC/EN 61984		
Overtoltage category	III	III	II
Pollution degree	3	2	2
Nominal voltage	500 V	-	-
Rated impulse withstand voltage	6 kV	-	-
Rated current	32 A	-	-

General information

Wiring direction Front-entry wiring

Connection Data

Clamping units	4
Total number of potentials	4

Connection 1

Connection technology	CAGE CLAMP®
Actuation type	Operating tool
Connectable conductor materials	Copper
Nominal cross-section	4 mm ² / 12 AWG
Solid conductor	0.08 ... 4 mm ² / 28 ... 12 AWG
Fine-stranded conductor	0.08 ... 4 mm ² / 28 ... 12 AWG
Strip length	8 ... 9 mm / 0.31 ... 0.35 inches
Pole number	4
Wiring direction	Front-entry wiring

Physical data

Width	20 mm / 0.787 inches
Height	45.2 mm / 1.78 inches
Depth	18.3 mm / 0.72 inches
Module width	5 mm / 0.197 inches

Mechanical data

Variable coding	Yes
Direct ground contact to DIN-rail/drilled hole/housing	No
Marking level	Side marking
Anti-rotation protection	Yes

Plug-in connection

Contact type (pluggable connector)	Female connector/socket
Connector (connection type)	for conductor
Mismating protection	No
Plugging without loss of pin spacing	Yes

Material data

Note (material data)	Information on material specifications can be found here
Color	gray
Material group	I
Insulation material (main housing)	Polyamide (PA66)
Flammability class per UL94	V0
Fire load	0.185 MJ
Halogen-free	Yes
Weight	12.5 g

Environmental requirements

Processing temperature	-35 ... +85 °C
Continuous operating temperature	-60 ... +105 °C

Commercial data

Product Group	18 (X-COM-System)
PU (SPU)	50 pcs
Packaging type	Box
Country of origin	DE
GTIN	4044918471442
Customs tariff number	85366990990

Product Classification

UNSPSC	39121409
eCl@ss 10.0	27-14-11-06
eCl@ss 9.0	27-14-11-06
ETIM 9.0	EC001284
ETIM 10.0	EC001284
ECCN	NO US CLASSIFICATION

Environmental Product Compliance

RoHS Compliance Status	Compliant, No Exemption
------------------------	-------------------------

Approvals / Certificates

General approvals



Approval	Standard	Certificate Name
CCA DEKRA Certification B.V.	EN 60947	NTR NL-7626
CCA DEKRA Certification B.V.	EN 61984	2190419.02
CCA DEKRA Certification B.V.	IEC 61984	NL-47799/A1
CSA CSA Group	C22.2	1101144
KEMA/KEUR DEKRA Certification B.V.	EN 60947	2190419.01
UL Underwriters Laboratories Inc.	UL 1059	E45172
UL Underwriters Laboratories Inc.	UL 1977	E 45171

Declarations of conformity and manufacturer's declarations



Approval	Standard	Certificate Name
EU-Declaration of Conformity WAGO GmbH & Co. KG	-	-
Railway WAGO GmbH & Co. KG	-	Z00004428.000

Approvals for marine applications



Approval	Standard	Certificate Name
ABS American Bureau of Shipping	EN 60947	24-0152298-PDA
DNV GL Det Norske Veritas, Germanischer Lloyd	-	TAE00001V2
PRS Polski Rejestr Statków	-	TE/1094/880590/23

Downloads

Environmental Product Compliance

Compliance Search

Environmental Product Compliance 769-104



Documentation

Bid Text

769-104	19.02.2019	xml 3.20 KB	
769-104	04.10.2017	doc 25.00 KB	

CAD/CAE-Data

CAD data

2D/3D Models 769-104



CAE data

EPLAN Data Portal 769-104



WSCAD Universe 769-104



ZUKEN Portal 769-104



1 Compatible Products

1.1 Optional Accessories

1.1.1 Cover

1.1.1.1 Cover



[Item No.: 769-436](#)

Jumper cover; for 1-conductor female plugs; for 5 poles; gray

1.1.2 Ferrule

1.1.2.1 Ferrule



[Item No.: 216-301](#)

Ferrule; Sleeve for 0.25 mm² / AWG 24; insulated; electro-tin plated; yellow



[Item No.: 216-302](#)

Ferrule; Sleeve for 0.34 mm² / 22 AWG; insulated; electro-tin plated; light turquoise



[Item No.: 216-201](#)

Ferrule; Sleeve for 0.5 mm² / 20 AWG; insulated; electro-tin plated; electrolytic copper; acc. to DIN 46228, Part 4/09.90; white



[Item No.: 216-101](#)

Ferrule; Sleeve for 0.5 mm² / AWG 22; un-insulated; electro-tin plated; silver-colored



[Item No.: 216-202](#)

Ferrule; Sleeve for 0.75 mm² / 18 AWG; insulated; electro-tin plated; gray



[Item No.: 216-102](#)

Ferrule; Sleeve for 0.75 mm² / AWG 20; un-insulated; electro-tin plated; silver-colored



[Item No.: 216-203](#)

Ferrule; Sleeve for 1 mm² / AWG 18; insulated; electro-tin plated; red



[Item No.: 216-103](#)

Ferrule; Sleeve for 1 mm² / AWG 18; un-insulated; electro-tin plated

1.1.2.1 Ferrule



Item No.: 216-204

Ferrule; Sleeve for 1.5 mm² / AWG 16; insulated; electro-tin plated; black

Item No.: 216-104

Ferrule; Sleeve for 1.5 mm² / AWG 16; un-insulated; electro-tin plated; silver-colored

Item No.: 216-206

Ferrule; Sleeve for 2.5 mm² / AWG 14; insulated; electro-tin plated; blue

1.1.3 Insulation stop

1.1.3.1 Insulation stop



Item No.: 769-470

Insulation stop; 0.08 - 0.2 mm² "s" (0.14 mm² "f-st"); 5 pieces/strip; white

Item No.: 769-471

Insulation stop; 0.25 - 0.5 mm²; 5 pieces/strip; light gray

Item No.: 769-472

Insulation stop; 0.75 - 1 mm²; 5 pieces/strip; dark gray

1.1.4 Jumper

1.1.4.1 Jumper



Item No.: 769-402

Jumper; insulated; gray

1.1.5 Locking system

1.1.5.1 Locking system



Item No.: 769-430

Locking lever; for female connectors; 1 part; Pin spacing 5 mm; 2-pole; gray

Item No.: 769-431

Locking lever; for female connectors; 1 part; Pin spacing 5 mm; 2-pole; orange

1.1.6 Marking

1.1.6.1 Label



Item No.: 210-805

Labels; for Smart Printer; permanent adhesive; 6 x 15 mm; 3000 pieces on roll; white

Item No.: 210-805/000-002

Labels; for Smart Printer; permanent adhesive; 6 x 15 mm; 3000 pieces on roll; yellow

1.1.6.2 Marker



Item No.: 2009-145

Mini-WSB Inline; for Smart Printer; 1700 pieces on roll; stretchable 5 - 5.2 mm; plain; snap-on type; white

Item No.: 248-501

Mini-WSB marking card; as card; not stretchable; plain; snap-on type; white

1.1.6.3 Marking strip



Item No.: 210-831

Marking strips; on reel; 2.3 mm wide; plain; Self-adhesive; white

Item No.: 210-832

Marking strips; on reel; 3 mm wide; plain; Self-adhesive; white

Item No.: 210-834

Marking strips; on reel; 5 mm wide; plain; Self-adhesive; white

1.1.7 Protective warning marker

1.1.7.1 Cover



Item No.: 280-415

Protective warning marker; for 5 terminal blocks; with high-voltage symbol, black; yellow

1.1.8 Strain relief

1.1.8.1 Strain relief



Item No.: 769-1604

Strain relief housing; for female and male connectors; 2 parts; Pin spacing 5 mm; 4-pole; gray

Item No.: 769-412

Strain relief plate; for female and male connectors; 1 part; Pin spacing 5 mm; 4-to 5-pole; gray

1.1.9 Test and measurement

1.1.9.1 Testing accessories



Item No.: 210-136

Test plug; 2 mm Ø; with 500 mm cable; red

1.1.10 Tool

1.1.10.1 Operating tool



Item No.: 210-490

Operating tool

Item No.: 769-434

Operating tool; made of insulating material; 1-way; loose; white

Installation Notes

Conductor termination

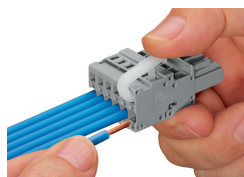
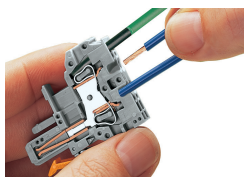

CAGE CLAMP® connection

Female plug: Inserting/removing a conductor via operating tool. Operation 90° to conductor is also possible. With ferruled conductors, it is necessary to use a terminal block one size smaller than the conductor's nominal cross-section.

Operating lever

Inserting a conductor – side-entry wiring (example shows a female plug).

Operating tool

Inserting a conductor – side-entry wiring (example shows a female plug). With ferruled conductors, it is necessary to use a terminal block one size smaller than the conductor's nominal cross-section.

Commoning

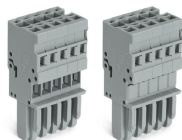
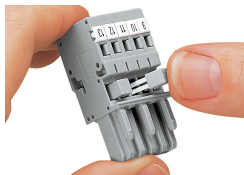

Commoning 1-conductor female plugs via miniature adjacent jumpers.

Jumper cover for 1-conductor female plugs

Coding



Coding a female plug by removing coding finger(s) via cutting tool. Do not remove the first and last coding fingers or use an additional locking lever.

Locking system

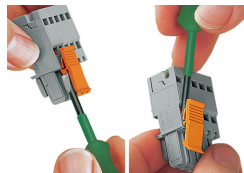

Locking/releasing a lever.

Strain relief

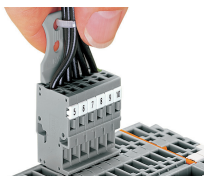

Removing a female plug via conductor bundle provided with strain relief plate.

Marking



Labeling a female plug with CAGE CLAMP® connection via Mini-WSB Quick Markers.