

NPN Epitaxial Silicon Transistor

KSD5041

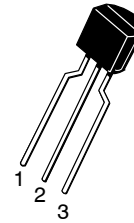

- 1. Emitter
- 2. Collector
- 3. Base

TO-92-3 LF
CASE 135AR

Features

- AF Output Amplifier for Electronic Flash Unit
- Low Collector-Emitter Saturation Voltage
- High Performance at Low Supply Voltage
- These are Pb-Free Devices

ABSOLUTE MAXIMUM RATINGS

(T_A = 25 °C unless otherwise noted.)

Symbol	Parameter	Value	Unit
V _{CB0}	Collector-Base Voltage	40	V
V _{CEO}	Collector-Emitter Voltage	20	V
V _{EBO}	Emitter-Base Voltage	7	V
I _C	Collector Current	5	A
T _J	Junction Temperature	150	°C
T _{STG}	Storage Temperature	-55 to 150	°C

Stresses exceeding those listed in the Maximum Ratings table may damage the device. If any of these limits are exceeded, device functionality should not be assumed, damage may occur and reliability may be affected.

MARKING DIAGRAM

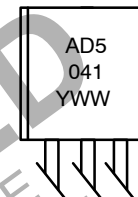

- A = Assembly Code
- D5041 = Device Code
- YWW = Date Code

ORDERING INFORMATION

Device	Package	Shipping
KSD5041RTA	TO-92-3LF (Pb-Free)	2000 / Fan-Fold

THERMAL CHARACTERISTICS

(T_A = 25 °C unless otherwise noted.) (Note 1)

Symbol	Parameter	Value	Unit
P _D	Power Dissipation	0.75	W
	Derate Above 25 °C	6.0	mW/°C
R _{θJA}	Thermal Resistance, Junction-to-Ambient	166.6	°C/W

- 1. PCB size: FR-4, 76 mm × 114 mm × 1.57 mm (3.0 inch × 4.5 inch × 0.062 inch) with minimum land pattern size.

ELECTRICAL CHARACTERISTICS (T_A = 25°C unless otherwise noted)

Symbol	Parameter	Conditions	Min	Typ	Max	Unit
BV _{CEO}	Collector-Emitter Breakdown Voltage	I _C = 1 mA, I _B = 0	20	-	-	V
BV _{EBO}	Emitter-Base Breakdown Voltage	I _E = 10 μA, I _C = 0	7	-	-	V
I _{CBO}	Collector Cut-Off Current	V _{CB} = 10 V, I _E = 0	-	-	0.1	μA
I _{EBO}	Emitter Cut-Off Current	V _{EB} = 7 V, I _C = 0	-	-	0.1	μA
h _{FE1}	DC Current Gain	V _{CE} = 2 V, I _C = 0.5 A	340	-	600	
h _{FE2}		V _{CE} = 2 V, I _C = 2 A	150	-	-	
V _{CE(sat)}	Collector-Emitter Saturation Voltage	I _C = 3 A, I _B = 0.1 A	-	-	1	V
f _T	Current Gain Bandwidth Product	V _{CE} = 6 V, I _C = 50 mA	-	150	-	MHz
C _{ob}	Output Capacitance	V _{CB} = 20 V, I _E = 0, f = 1 MHz	-	-	50	pF

Product parametric performance is indicated in the Electrical Characteristics for the listed test conditions, unless otherwise noted. Product performance may not be indicated by the Electrical Characteristics if operated under different conditions.

TYPICAL CHARACTERISTICS

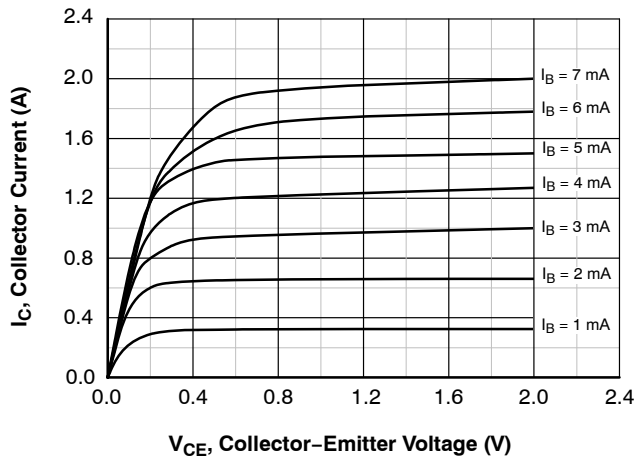

Figure 1. Static Characteristic

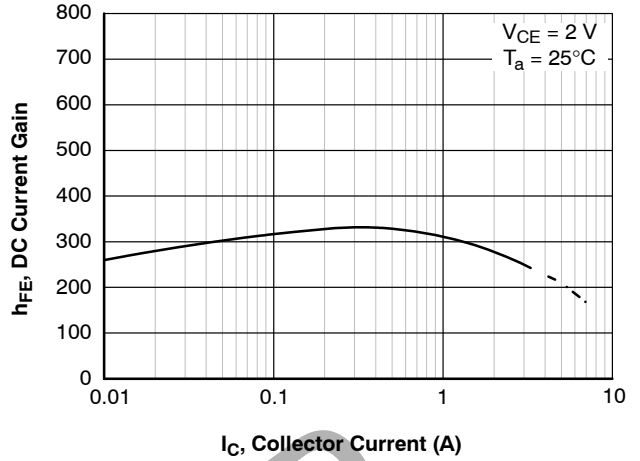

Figure 2. DC Current Gain

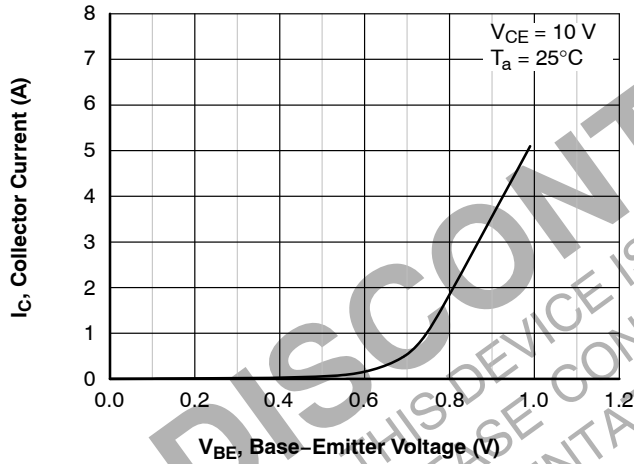

Figure 3. Base-Emitter Saturation Voltage

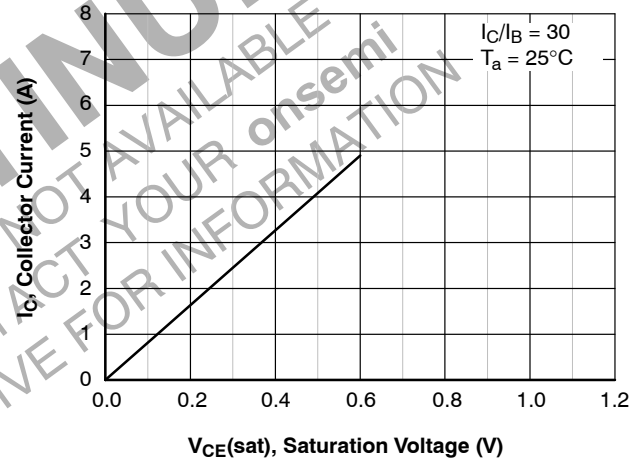

Figure 4. Collector-Emitter Saturation Voltage

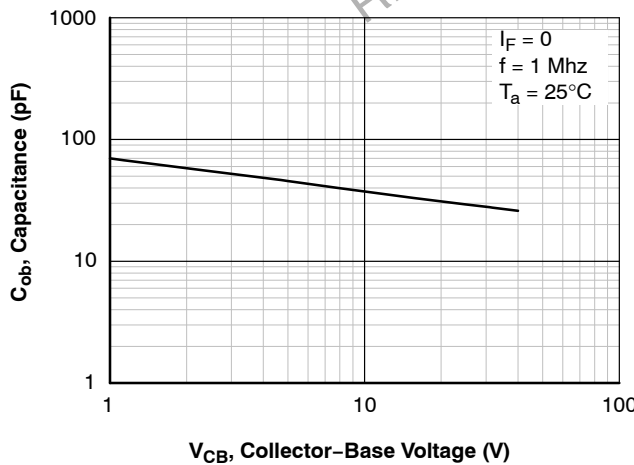

Figure 5. Collector Output Capacitance

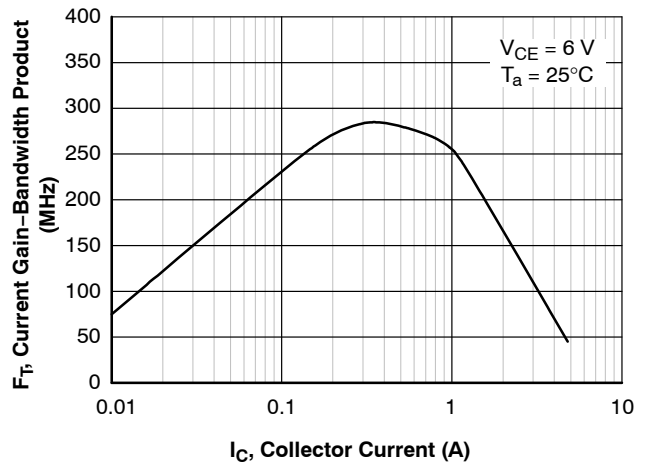

Figure 6. Current Gain Bandwidth Product

TYPICAL CHARACTERISTICS (Continued)

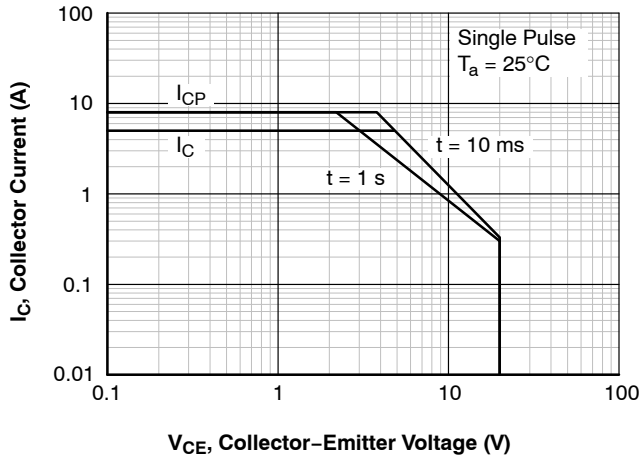

Figure 7. Safe Operating Area

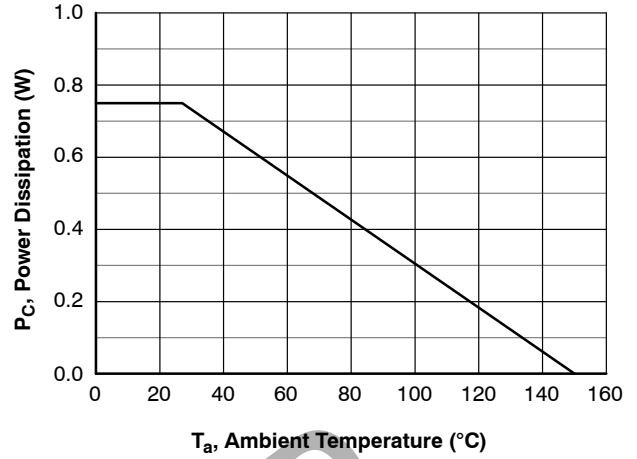

Figure 8. Power Derating

DISCONTINUED

THIS DEVICE IS NOT AVAILABLE
PLEASE CONTACT YOUR onsemi
REPRESENTATIVE FOR INFORMATION

KSD5041

REVISION HISTORY

Revision	Description of Changes	Date
3	Data Sheet Discontinued.	1/14/2026

This document has undergone updates prior to the inclusion of this revision history table. The changes tracked here only reflect updates made on the noted approval dates.

DISCONTINUED
THIS DEVICE IS NOT AVAILABLE
PLEASE CONTACT YOUR onsemi
REPRESENTATIVE FOR INFORMATION

TO-92 3 4.83x4.76 LEADFORMED
CASE 135AR
ISSUE O

DATE 30 SEP 2016

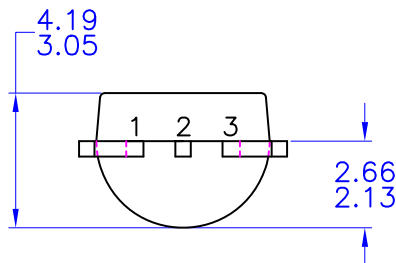
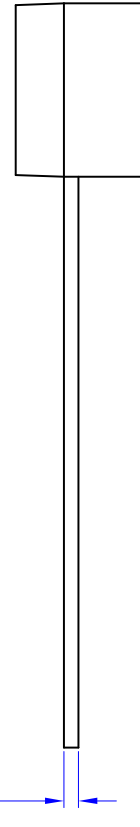
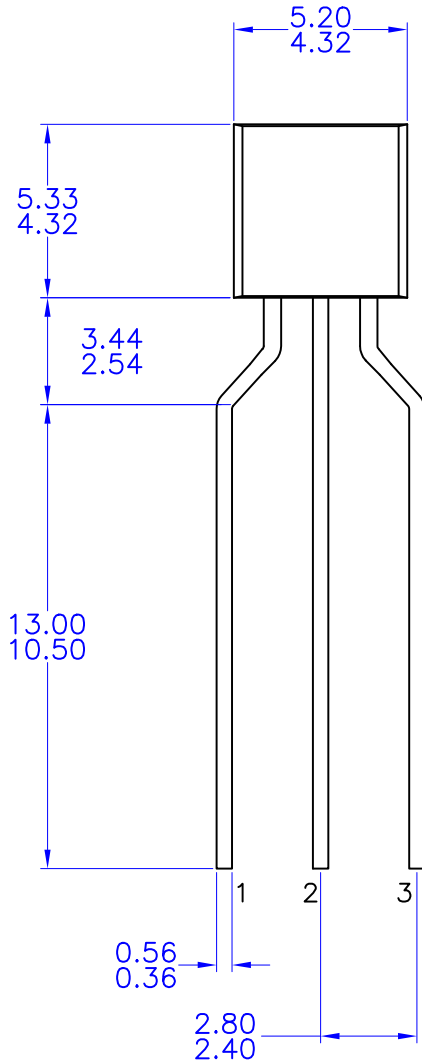

NOTES: UNLESS OTHERWISE SPECIFIED

- A) DRAWING WITH REFERENCE TO JEDEC TO-92 RECOMMENDATIONS.
- B) ALL DIMENSIONS ARE IN MILLIMETERS.
- C) DRAWING CONFORMS TO ASME Y14.5M-1994

DOCUMENT NUMBER:	98AON13879G	Electronic versions are uncontrolled except when accessed directly from the Document Repository. Printed versions are uncontrolled except when stamped "CONTROLLED COPY" in red.
DESCRIPTION:	TO-92 3 4.83X4.76 LEADFORMED	PAGE 1 OF 1

onsemi and ONSEMI are trademarks of Semiconductor Components Industries, LLC dba onsemi or its subsidiaries in the United States and/or other countries. onsemi reserves the right to make changes without further notice to any products herein. onsemi makes no warranty, representation or guarantee regarding the suitability of its products for any particular purpose, nor does onsemi assume any liability arising out of the application or use of any product or circuit, and specifically disclaims any and all liability, including without limitation special, consequential or incidental damages. onsemi does not convey any license under its patent rights nor the rights of others.

onsemi, **Onsemi**, and other names, marks, and brands are registered and/or common law trademarks of Semiconductor Components Industries, LLC dba "**onsemi**" or its affiliates and/or subsidiaries in the United States and/or other countries. **onsemi** owns the rights to a number of patents, trademarks, copyrights, trade secrets, and other intellectual property. A listing of **onsemi**'s product/patent coverage may be accessed at www.onsemi.com/site/pdf/Patent-Marking.pdf. **onsemi** reserves the right to make changes at any time to any products or information herein, without notice. The information herein is provided "as-is" and **onsemi** makes no warranty, representation or guarantee regarding the accuracy of the information, product features, availability, functionality, or suitability of its products for any particular purpose, nor does **onsemi** assume any liability arising out of the application or use of any product or circuit, and specifically disclaims any and all liability, including without limitation special, consequential or incidental damages. Buyer is responsible for its products and applications using **onsemi** products, including compliance with all laws, regulations and safety requirements or standards, regardless of any support or applications information provided by **onsemi**. "Typical" parameters which may be provided in **onsemi** data sheets and/or specifications can and do vary in different applications and actual performance may vary over time. All operating parameters, including "Typicals" must be validated for each customer application by customer's technical experts. **onsemi** does not convey any license under any of its intellectual property rights nor the rights of others. **onsemi** products are not designed, intended, or authorized for use as a critical component in life support systems or any FDA Class 3 medical devices or medical devices with a same or similar classification in a foreign jurisdiction or any devices intended for implantation in the human body. Should Buyer purchase or use **onsemi** products for any such unintended or unauthorized application, Buyer shall indemnify and hold **onsemi** and its officers, employees, subsidiaries, affiliates, and distributors harmless against all claims, costs, damages, and expenses, and reasonable attorney fees arising out of, directly or indirectly, any claim of personal injury or death associated with such unintended or unauthorized use, even if such claim alleges that **onsemi** was negligent regarding the design or manufacture of the part. **onsemi** is an Equal Opportunity/Affirmative Action Employer. This literature is subject to all applicable copyright laws and is not for resale in any manner.

ADDITIONAL INFORMATION

TECHNICAL PUBLICATIONS:

Technical Library: www.onsemi.com/design/resources/technical-documentation
onsemi Website: www.onsemi.com

ONLINE SUPPORT: www.onsemi.com/support

For additional information, please contact your local Sales Representative at www.onsemi.com/support/sales

