

Data Sheet | Item Number: 254-862

Stackable PCB terminal block; 2.5 mm²; Pin spacing 10/10.16 mm; 1-pole; PUSH WIRE®; dark gray

<https://www.wago.com/254-862>



Color: ■ dark gray

Similar to illustration

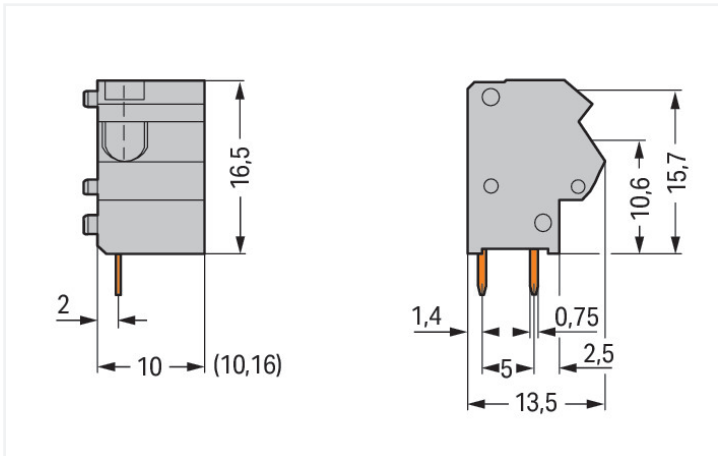
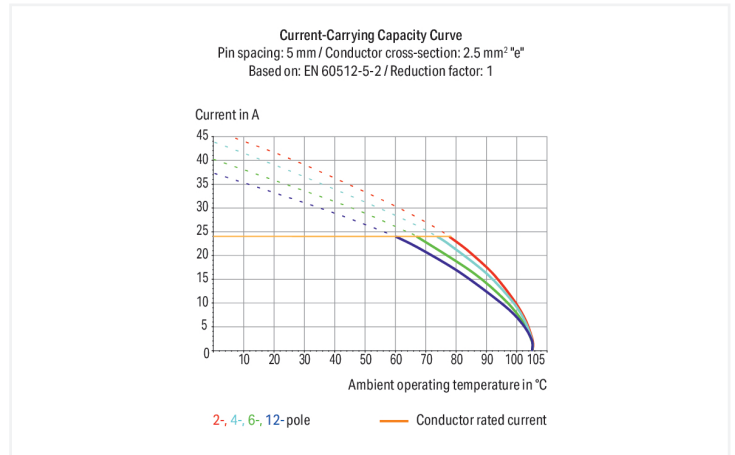

Dimensions in mm

PCB terminal block, 254 Series, dark gray

This PCB terminal block (item number 254-862) is designed to connect conductors quickly and easily. It is a universal connector that can be used almost anywhere, for example, as a pluggable PCB connector, panel feedthrough header, connector for rail-mount terminal blocks, or a floating connector for different mounting methods. Strip lengths must be between 10 and 12 mm when connecting conductors to this PCB terminal block. This product features one conductor terminal and utilizes PUSH WIRE®. Our PUSH WIRE® connection is the simple and reliable method for connecting solid conductors. The item's dimensions are (11.7 x 19.7 x 13.5) mm (width x height x depth). Depending on the conductor type, this PCB terminal block is ideal for conductor cross sections ranging from 0.5 mm² to 2.5 mm².

Tin is used for coating the contact surfaces. This PCB terminal block is operated with an operating tool. THT is used to assemble the PCB terminal block. The conductor is designed to be inserted into the board at an angle of 45°.

Notes

Variants:	Other colors Versions for Ex i Other versions (or variants) can be requested from WAGO Sales or configured at https://configurator.wago.com/ .
-----------	---

Electrical data

Ratings per	IEC/EN 60664-1			Approvals per	UL 1059		
Overvoltage category	III	III	II	Use group	B	C	D
Pollution degree	3	2	2	Rated voltage	300 V	-	300 V
Nominal voltage	630 V	1000 V	1000 V	Rated current	10 A	-	10 A
Rated impulse withstand voltage	8 kV	8 kV	8 kV				
Rated current	24 A	24 A	24 A				

Approvals per	CSA		
Use group	B	C	D
Rated voltage	300 V	-	300 V
Rated current	10 A	-	10 A

Connection Data

Clamping units	1	Connection 1	
Total number of potentials	1	Connection technology	PUSH WIRE®
Number of connection types	1	Actuation type	Operating tool
Number of levels	1	Solid conductor	0.5 ... 2.5 mm ² / 20 ... 12 AWG
		Fine-stranded conductor; with insulated ferrule	0.5 ... 1.5 mm ²
		Fine-stranded conductor; with uninsulated ferrule	0.5 ... 1.5 mm ²
		Note (conductor cross-section)	12 AWG: THHN, THWN
		Strip length	10 ... 12 mm / 0.39 ... 0.47 inches
		Conductor connection direction to PCB	45°
		Pole number	1

Physical data

Pin spacing	10/10.16 mm / 0.394/0.4 inches
Width	11.7 mm / 0.461 inches
Height	19.7 mm / 0.776 inches
Height from the surface	15.7 mm / 0.618 inches
Depth	13.5 mm / 0.531 inches
Solder pin length	4 mm
Solder pin dimensions	0.5 x 0.75 mm
Drilled hole diameter	1.1 (+0.1) mm

PCB contact

PCB contact	THT
Solder pin arrangement	within the terminal block (in-line)
Number of solder pins per potential	2

Material data

Note (material data)	Information on material specifications can be found here
Color	dark gray
Material group	I
Insulation material (main housing)	Polyamide (PA66)
Flammability class per UL94	V0
Clamping spring material	Chrome-nickel spring steel (CrNi)
Contact material	Electrolytic copper (E _{Cu})
Contact Plating	Tin
Fire load	0.027 MJ
Weight	1.6 g

Environmental requirements

Limit temperature range	-60 ... +105 °C
-------------------------	-----------------

Commercial data

Product Group	4 (Printed Circuit Connectors)
PU (SPU)	300 (100) pcs
Packaging type	Box
Country of origin	PL
GTIN	4044918943147
Customs tariff number	85369010000

Product Classification

UNSPSC	39121409
eCl@ss 10.0	27-44-04-01
eCl@ss 9.0	27-44-04-01
ETIM 9.0	EC002643
ETIM 10.0	EC002643
ECCN	NO US CLASSIFICATION

Environmental Product Compliance

RoHS Compliance Status	Compliant, No Exemption
------------------------	-------------------------

Approvals / Certificates

General approvals



Approval	Standard	Certificate Name
CCA DEKRA Certification B.V.	EN 60947	NTR NL 7375
CSA CSA Group	C22.2	70154033

General approvals

UR Underwriters Laboratories Inc.	UL 1059	E45172
---	---------	--------

Approvals for marine applications



Approval	Standard	Certificate Name
ABS American Bureau of Ship- ping	-	24-0095975-PDA
DNV DNV GL SE	-	TAE000016Z
PRS Polski Rejestr Statków	-	TE/1095/880590/23

Downloads

Environmental Product Compliance

Compliance Search
Environmental Product Compliance 254-862 ↓

Documentation

Additional Information			
Technical Section	03.04.2019	pdf 2027.26 KB	↓

CAD/CAE-Data

CAD data
2D/3D Models 254-862 ↓

CAE data
EPLAN Data Portal 254-862 ↓
ZUKEN Portal 254-862 ↓

PCB Design

Symbol and Footprint via SamacSys 254-862 ↓
Symbol and Footprint via Ultra Librarian 254-862 ↓

1 Compatible Products

1.1 Required Accessories

1.1.1 End plate

1.1.1.1 End plate



Item No.: 254-400

End plate; 1 mm thick; snap-fit type; blue

Item No.: 254-200

End plate; 1 mm thick; snap-fit type; dark gray

Item No.: 254-100

End plate; 1 mm thick; snap-fit type; gray

Item No.: 254-300

End plate; 1 mm thick; snap-fit type; light gray



Item No.: 254-700

End plate; 1 mm thick; snap-fit type; light green

Item No.: 254-600

End plate; 1 mm thick; snap-fit type; orange

1.2 Optional Accessories

1.2.1 Ferrule

1.2.1.1 Ferrule



Item No.: 216-241

Ferrule; Sleeve for 0.5 mm² / 20 AWG; insulated; electro-tin plated; electrolytic copper; gastight crimped; acc. to DIN 46228, Part 4/09.90; white

Item No.: 216-141

Ferrule; Sleeve for 0.5 mm² / 20 AWG; un-insulated; electro-tin plated; electrolytic copper; gastight crimped; acc. to DIN 46228, Part 1/08.92

Item No.: 216-242

Ferrule; Sleeve for 0.75 mm² / 18 AWG; insulated; electro-tin plated; electrolytic copper; gastight crimped; acc. to DIN 46228, Part 4/09.90; gray

Item No.: 216-262

Ferrule; Sleeve for 0.75 mm² / 18 AWG; insulated; electro-tin plated; electrolytic copper; gastight crimped; acc. to DIN 46228, Part 4/09.90; gray



Item No.: 216-142

Ferrule; Sleeve for 0.75 mm² / 18 AWG; un-insulated; electro-tin plated; electrolytic copper; gastight crimped; acc. to DIN 46228, Part 1/08.92

Item No.: 216-243

Ferrule; Sleeve for 1 mm² / AWG 18; insulated; electro-tin plated; electrolytic copper; gastight crimped; acc. to DIN 46228, Part 4/09.90; red

Item No.: 216-263

Ferrule; Sleeve for 1 mm² / AWG 18; insulated; electro-tin plated; electrolytic copper; gastight crimped; acc. to DIN 46228, Part 4/09.90; red

Item No.: 216-143

Ferrule; Sleeve for 1 mm² / AWG 18; un-insulated; electro-tin plated; electrolytic copper; gastight crimped; acc. to DIN 46228, Part 1/08.92



Item No.: 216-244

Ferrule; Sleeve for 1.5 mm² / AWG 16; insulated; electro-tin plated; electrolytic copper; gastight crimped; acc. to DIN 46228, Part 4/09.90; black

Item No.: 216-264

Ferrule; Sleeve for 1.5 mm² / AWG 16; insulated; electro-tin plated; electrolytic copper; gastight crimped; acc. to DIN 46228, Part 4/09.90; black

Item No.: 216-144

Ferrule; Sleeve for 1.5 mm² / AWG 16; un-insulated; electro-tin plated; electrolytic copper; gastight crimped; acc. to DIN 46228, Part 1/08.92; silver-colored

1.2.2 Marking

1.2.2.1 Marking strip



Item No.: 210-332/1000-202

Marking strips; as a DIN A4 sheet; MARKED; 1-16 (80x); Height of marker strip: 3 mm; Strip length 182 mm; Horizontal marking; Self-adhesive; white

Item No.: 210-332/1016-202

Marking strips; as a DIN A4 sheet; MARKED; 1-16 (80x); Height of marker strip: 3 mm; Strip length 182 mm; Horizontal marking; Self-adhesive; white

Item No.: 210-332/1000-204

Marking strips; as a DIN A4 sheet; MARKED; 17-31 (80x); Height of marker strip: 3 mm; Strip length 182 mm; Horizontal marking; Self-adhesive; white

Item No.: 210-332/1016-204

Marking strips; as a DIN A4 sheet; MARKED; 17-31 (80x); Height of marker strip: 3 mm; Strip length 182 mm; Horizontal marking; Self-adhesive; white



Item No.: 210-332/1000-206

Marking strips; as a DIN A4 sheet; MARKED; 33-48 (80x); Height of marker strip: 3 mm; Strip length 182 mm; Horizontal marking; Self-adhesive; white

Item No.: 210-332/1016-206

Marking strips; as a DIN A4 sheet; MARKED; 33-48 (80x); Height of marker strip: 3 mm; Strip length 182 mm; Horizontal marking; Self-adhesive; white

1.2.3 Test and measurement

1.2.3.1 Testing accessories



Item No.: 210-136

Test plug; 2 mm Ø; with 500 mm cable; red

1.2.4 Tool

1.2.4.1 Operating tool



Item No.: 210-658

Operating tool; Blade: 3.5 x 0.5 mm; with a partially insulated shaft; angled; short; multi-coloured



Item No.: 210-720

Operating tool; Blade: 3.5 x 0.5 mm; with a partially insulated shaft; multicoloured



Item No.: 210-657

Operating tool; Blade: 3.5 x 0.5 mm; with a partially insulated shaft; short; multicoloured

Installation Notes

Conductor termination

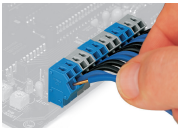

Insert solid conductors via push-in termination.

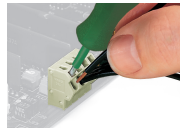

Inserting a tip-bonded conductor via screwdriver.

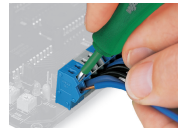

Removing a solid conductor.

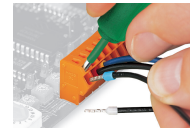

Inserting/removing a ferruled conductor.

Marking

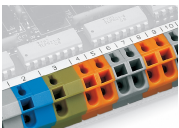

Labeling via self-adhesive marking strips.

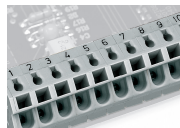

Labeling via factory direct marking.

Testing



Testing with 2 mm Ø test plug.

Application

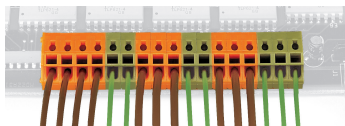

Mixed terminal strips can be assembled using different housing colors for the formation of groups.

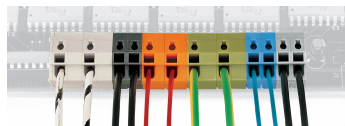

Mixed terminal strips can be assembled using different pin spacing and housing colors for the formation of groups.

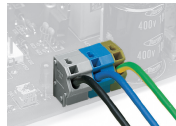

Application example: field-wiring terminal strip