

DIALIGHT PART NUMBER	LED COLOR			
	POSITION 1	POSITION 2	POSITION 3	POSITION 4
568-0700-044F	** BLANK **	** BLANK **	YELLOW/GREEN	YELLOW/GREEN
568-0700-111F	** BLANK **	RED/GREEN	RED/GREEN	RED/GREEN
568-0700-444F	** BLANK **	YELLOW/GREEN	YELLOW/GREEN	YELLOW/GREEN
568-0701-000F	RED/GREEN	** BLANK **	** BLANK **	** BLANK **
568-0701-001F	RED/GREEN	** BLANK **	** BLANK **	RED/GREEN
568-0701-041F	RED/GREEN	** BLANK **	YELLOW/GREEN	RED/GREEN
568-0701-100F	RED/GREEN	RED/GREEN	** BLANK **	** BLANK **
568-0701-101F	RED/GREEN	RED/GREEN	** BLANK **	RED/GREEN
568-0701-110F	RED/GREEN	RED/GREEN	RED/GREEN	** BLANK **
568-0701-111F	RED/GREEN	RED/GREEN	RED/GREEN	RED/GREEN
568-0701-144F	RED/GREEN	RED/GREEN	YELLOW/GREEN	YELLOW/GREEN
568-0701-411F	RED/GREEN	YELLOW/GREEN	RED/GREEN	RED/GREEN
568-0701-414F	RED/GREEN	YELLOW/GREEN	RED/GREEN	YELLOW/GREEN
568-0701-444F	RED/GREEN	YELLOW/GREEN	YELLOW/GREEN	YELLOW/GREEN
568-0702-211F	GREEN	GREEN	RED/GREEN	RED/GREEN
568-0702-244F	GREEN	GREEN	YELLOW/GREEN	YELLOW/GREEN
568-0702-311F	GREEN	YELLOW	RED/GREEN	RED/GREEN
568-0704-144F	YELLOW/GREEN	RED/GREEN	YELLOW/GREEN	YELLOW/GREEN
568-0704-400F	YELLOW/GREEN	YELLOW/GREEN	** BLANK **	** BLANK **
568-0704-411F	YELLOW/GREEN	YELLOW/GREEN	RED/GREEN	RED/GREEN
568-0704-444F	YELLOW/GREEN	YELLOW/GREEN	YELLOW/GREEN	YELLOW/GREEN
568-0704-445F	YELLOW/GREEN	YELLOW/GREEN	YELLOW/GREEN	RED/YELLOW
568-0704-511F	YELLOW/GREEN	RED/YELLOW	RED/GREEN	RED/GREEN
568-2200-111F	** BLANK **	RED TINTED NON-DIFFUSED	RED TINTED NON-DIFFUSED	RED TINTED NON-DIFFUSED

RoHS Compliant 568-07xx-xxxF and 568-2200-111F

Part Numbers with the "F" suffix ending are RoHS Compliant.
 Example: 568-0700-044F, 568-0704-444F, 568-2200-111F.
 The bag packaging is marked with "RoHS Compliant" label or equivalent markings. Parts can be wave soldered, dip soldered, or hand soldered using typical lead-free soldering process with max 260°C temp. for 5 sec.

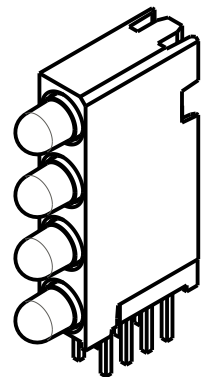

SCALE 2.000

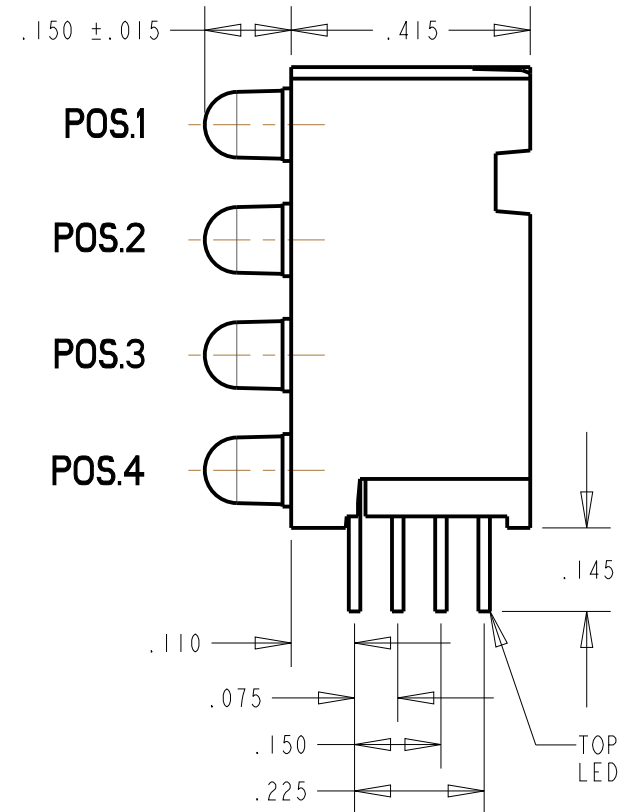
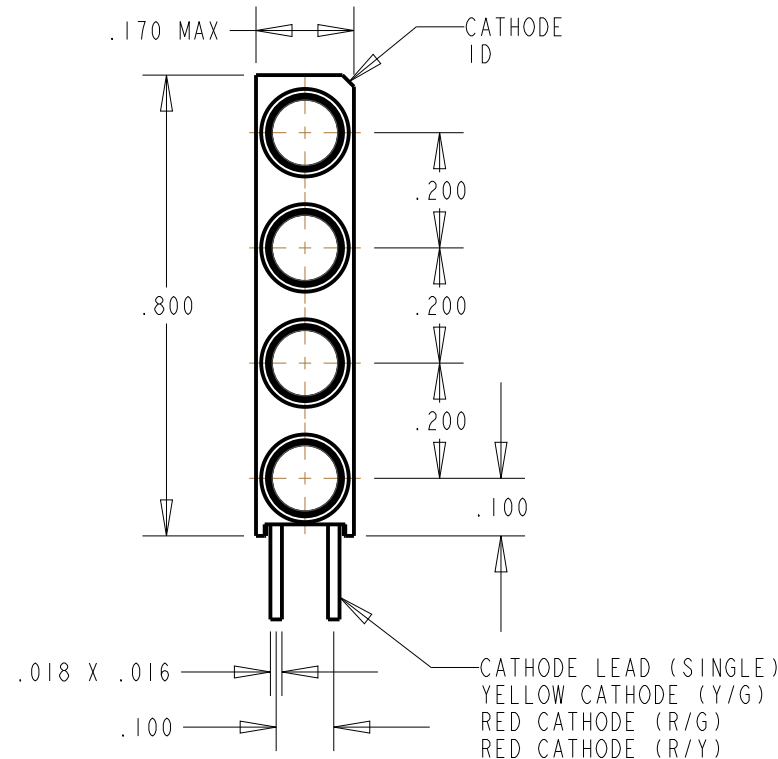

NOTES:

- LEADS TO FIT INTO HOLES SPACED AS PER HOLE PATTERN
- LEADS TO BE FREE OF DEFORMATION AFTER BENDING AND CUTTING.
- LED LEAD DIMENSIONS SHOWN ARE MEASURED AT HOUSING EXIT.
- WHEN A ZERO APPEARS IN THE LAST 4 DIGITS OF THE PART NUMBER THIS MEANS NO LED REQUIRED IN THAT POSITION
- DIALIGHT PART NUMBERS: 568-07XX-XXXF AND 568-2200-111F

OPERATING CHARACTERISTICS AT 25°C AMBIENT

LED COLOR	LUMINOUS INTENSITY TEST CONDITION	LUMINOUS INTENSITY (mcd)		FORWARD VOLTAGE @ I _F = 20 mA (V)		REVERSE CURRENT (μA)	DOMINANT WAVELENGTH (nm)	PEAK WAVELENGTH (nm)	VIEWING ANGLE (DEG)
		MIN	TYP	TYP	MAX				
RED TINTED NON-DIFF.	I _F = 10mA	8.7	29	2.0	2.6	100 @ V _R =5V	623	635	45
R/G DIFFUSED BI-COLOR LED	RED I _F = 10mA	1.2	5.6	2.0	2.6	100 @ V _R =5V	621	630	200
	GREEN I _F = 10mA	1.5	8.7	2.1	2.6	100 @ V _R =5V	569	565	200
Y/G DIFFUSED BI-COLOR LED	YELLOW I _F = 10mA	3.0	5.7	2.1	2.6	100 @ V _R =5V	588	585	80
	GREEN I _F = 10mA	6.5	12.2	2.1	2.6	100 @ V _R =5V	569	565	80
R/Y DIFFUSED BI-COLOR LED	RED I _F = 20mA	2.5	8.7	2.0	2.6	100 @ V _R =5V	621	630	80
	YELLOW I _F = 20mA	2.5	8.7	2.1	2.6	100 @ V _R =5V	588	585	80

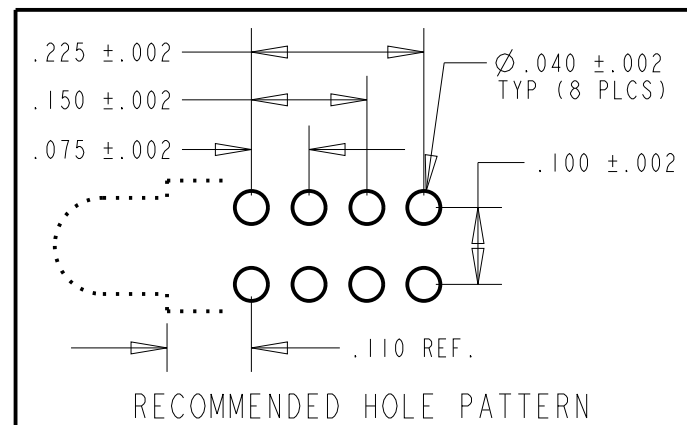
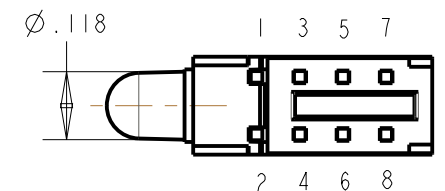
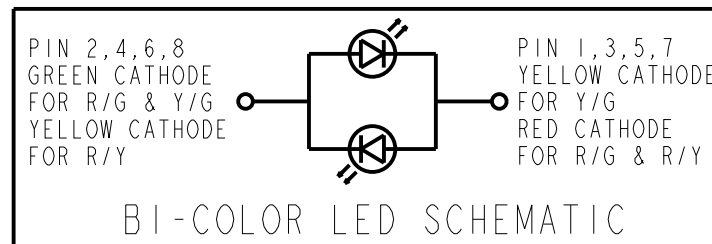
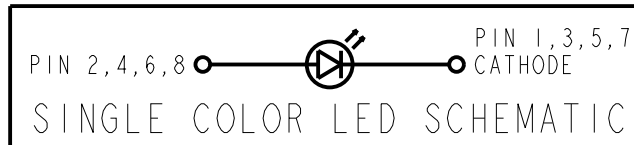

ABSOLUTE MAXIMUM RATINGS AT 25°C AMBIENT	RED TINTED NON-DIFF.	R/G BI-COLOR		Y/G BI-COLOR		Y/R BI-COLOR		UNITS
		RED	GREEN	YELLOW	GREEN	YELLOW	RED	
POWER DISSIPATION	100	100	100	60	100	60	100	mW
CONTINUOUS FORWARD CURRENT	30	30	30	20	30	20	30	mA
PEAK FORWARD CURRENT (1/10 DUTY CYCLE, 0.1 ms PULSE WIDTH)	120	90	90	80	120	80	120	mA
DERATE LINEARLY FROM 50°C	0.4	0.4	0.4	0.25	0.4	0.25	0.4	mA/°C
REVERSE VOLTAGE	5	5	5	5	5	5	5	V
STORAGE TEMPERATURE	-55 TO +100							°C
OPERATING TEMPERATURE	-55 TO +100							°C
	260							°C

REV	ECN NO	REVISIONS	DRN	CKD	APP	DATE
A	---	NEW RELEASE	TWC	TC	N.O.	8-9-05
B	---	ADDED P/N 568-0701-041F; .225±.002 HOLE PATTERN WAS .226±.002	TWC	MES	N.O.	11-16-05
C	---	ADDED P/N 568-0701-001F.	SM	MES	N.O.	7-18-05
D	---	ADDED P/N 568-0700-044F.	MES	AV	N.O.	1-5-07
E	---	ADDED P/N 568-0704-511F.	KLJ	N.O.	MES	3-5-09
F	---	ADDED P/N'S 568-0702-211F, -244F.	KLJ	JLC	N.O.	6-8-09
G	---	ADDED P/N 568-0702-311F	AJF	KLJ	NO	3-16-10
H	---	ADDED P/N 568-0704-445F UPDATED LED SPECS	WFB	JTD	NO	2-11-13

THIS DRAWING AND THE CONTENTS HEREIN ARE CONFIDENTIAL AND THE SOLE PROPERTY OF DIALIGHT. REPRODUCTION OF THIS DRAWING OR CONSTRUCTION OF ANY PARTS WITHIN THIS DRAWING ARE FORBIDDEN WITHOUT THE WRITTEN CONSENT OF DIALIGHT.		
SCALE: 3.000	DRAWING NUMBER	REV
ALL DIM'S IN: INCHES	C-17280	H
TOLERANCES: UNLESS OTHERWISE SPECIFIED	TITLE STANDARD 4X1 CBI BLOCK	
FRACTIONS: ±1/64	R&HS COMPLIANT	
DECIMALS (.XX): ±.02	MATERIAL	
DECIMALS (.XXX): ±.010	Dialight	
ANGLES: ±3°	1501 ROUTE 34 SOUTH	
FINISH:	FARMINGDALE, NJ 07727	
FSCM 83330	SHEET 1 OF 1	FAMILY TABLE: