

Data Sheet | Item Number: 2000-1203

2-conductor through terminal block; 1 mm²; suitable for Ex e II applications; side and center marking; for DIN-rail 35 x 15 and 35 x 7.5; Push-in CAGE CLAMP®; 1,00 mm²; red

<https://www.wago.com/2000-1203>

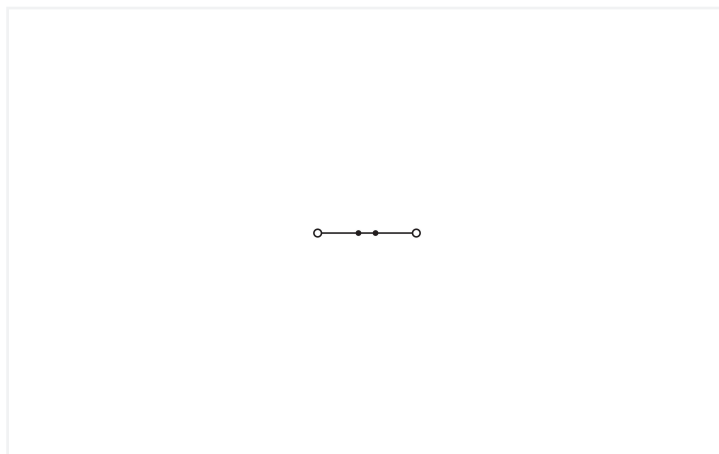
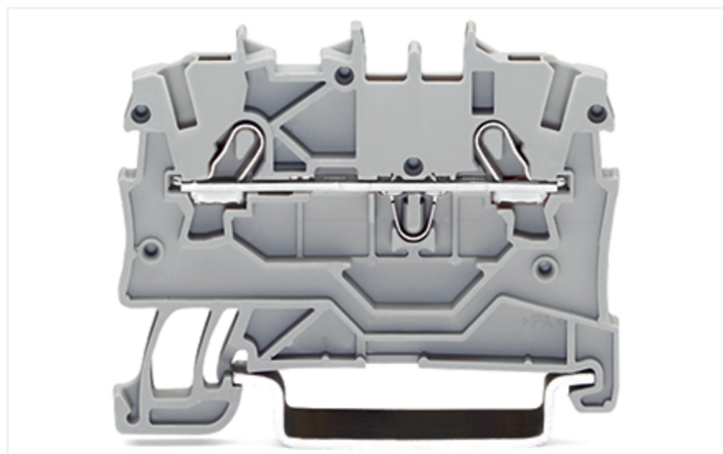

Color: ■ red

Similar to illustration

Similar to illustration

Through terminal block, 2000 Series, Push-in CAGE CLAMP®

Connecting conductors is quick and easy with this through terminal block (item number 2000-1203). Strip lengths must be between 9 and 11 mm when connecting conductors to this through terminal block. Whether for use in industry or building installations, our rail-mount through terminal blocks allow you to quickly and securely connect electrical conductors. They're perfect for either classic through-wiring or distributing potential, depending on the variant. Featuring conductor terminals along with Push-in CAGE CLAMP®, this product is highly versatile. Our Push-in CAGE CLAMP® is a universal, maintenance-free connection solution for all conductor types, boasting a key feature: It allows direct insertion of both solid and fine-stranded conductors with ferrules without needing tools. No preparation is required; for example, crimping the conductor's ferrule is not necessary. Dimensions: (3.5 x 48.5 x 39.5) mm (width x height x depth). Depending on the type of conductor, this through terminal block is ideal for conductor cross sections ranging from 0.14 mm² to 1.5 mm².

An operating tool is used to operate this through rail-mount terminal block. Our TOPJOB® S rail-mount terminal blocks guarantee reliable electrical connections in various industrial applications and modern building installations. They make wiring work easier as you can quickly plug in solid, stranded, and fine-stranded conductors with ferrules. This product is designed for specific Ex applications (please refer to the product datasheet).

Electrical data

Ratings per	IEC/EN 60947-7-1			Approvals per	UL 1059		
	III	III	II		Use group	B	C
Overvoltage category	III	III	II	Use group	B	C	D
Pollution degree	3	2	2	Rated voltage	600 V	600 V	-
Nominal voltage	800 V	-	-	Rated current	15 A	15 A	-
Rated impulse withstand voltage	8 kV	-	-				
Rated current	13.5 A	-	-				
Current at conductor cross-section (max.) mm ²	17.5 A	-	-				

Approvals per	CSA 22.2 No 158		
	B	C	D
Use group	B	C	D
Rated voltage	600 V	600 V	-
Rated current	10 A	10 A	-

Ex information	
Reference to hazardous areas	See application instructions in section "Knowledge and Downloads – Documentation – Additional Information: Technical Section; Technical Explanations"
Ratings per	ATEX: PTB 11 ATEX 1041 U / IECEx: PTB 11.0093U (Ex eb IIC Gb)
Rated voltage EN (Ex e II)	550 V
Rated current (Ex e II)	13 A
Rated current (Ex e II) with jumper	12 A

Power Loss	
Power loss, per pole (potential)	0.4338 W
Rated current I_N for power loss specification	13.5 A
Resistance value for specified, current-dependent power loss	0.00238 Ω

General information	
Wiring direction	Front-entry wiring

Connection Data		Connection 1	
Clamping units	2	Connection technology	Push-in CAGE CLAMP®
Total number of potentials	1	Actuation type	Operating tool
Number of levels	1	Connectable conductor materials	Copper
Number of jumper slots	2	Nominal cross-section	1 mm ²
		Solid conductor	0.14 ... 1.5 mm ² / 24 ... 16 AWG
		Solid conductor; push-in termination	0.5 ... 1.5 mm ² / 20 ... 16 AWG
		Fine-stranded conductor	0.14 ... 1.5 mm ² / 24 ... 16 AWG
		Fine-stranded conductor; with insulated ferrule	0.14 ... 0.75 mm ² / 24 ... 18 AWG
		Fine-stranded conductor; with ferrule; push-in termination	0.5 ... 0.75 mm ² / 20 ... 18 AWG
		Note (conductor cross-section)	Depending on the conductor characteristic, a conductor with a smaller cross-section can also be inserted via push-in termination.
		Strip length	9 ... 11 mm / 0.35 ... 0.43 inches
		Wiring direction	Front-entry wiring

Physical data	
Width	3.5 mm / 0.138 inches
Height	48.5 mm / 1.909 inches
Depth from upper-edge of DIN-rail	32.9 mm / 1.295 inches
Depth	39.5 mm / 1.555 inches

Mechanical data	
Mounting type	DIN-35 rail
Marking level	Center/side marking

Material data

Note (material data)	Information on material specifications can be found here
Color	red
Material group	I
Insulation material (main housing)	Polyamide (PA66)
Flammability class per UL94	V0
Fire load	0.079 MJ
Weight	3.6 g

Environmental requirements

Processing temperature	-35 ... +85 °C
Continuous operating temperature	-60 ... +105 °C

Environmental Testing

Test specification: Railway applications – Rolling stock – Electronic equipment	DIN EN 50155 (VDE 0115-200):2022-06
Test procedure: Railway applications – Rolling stock equipment – Vibration and shock tests	DIN EN 61373 (VDE 0115-0106):2011-04
Spectrum/Mounting location	Service life test, Category 1, Class A/B
Functional test with noise-like oscillations	Test passed according to Section 8 of the standard
Frequency	$f_1 = 5 \text{ Hz}$ to $f_2 = 150 \text{ Hz}$
Acceleration	0.101g (highest test level used for all axes)
Test duration per axis	10 min.
Test directions	X, Y and Z axes
Monitoring of contact faults and interruptions	Passed
Voltage drop measurement before and after each axis	Passed
Simulated service life test through increased levels of noise-like oscillations	Test passed according to Section 9 of the standard
Frequency	$f_1 = 5 \text{ Hz}$ to $f_2 = 150 \text{ Hz}$
Acceleration	0.572g (highest test level used for all axes)
Test duration per axis	5 h
Test directions	X, Y and Z axes
Extended testing: Monitoring of contact faults and interruptions	Passed
Extended testing: Voltage drop measurement before and after each axis	Passed
Shock test	Test passed according to Section 10 of the standard
Shock pulse form	Half sine
Acceleration	5g (highest test level used for all axes)
Shock duration	30 ms
Number of shocks (per axis)	3 pos. und 3 neg.
Test directions	X, Y and Z axes
Extended testing: Monitoring of contact faults and interruptions	Passed
Extended testing: Voltage drop measurement before and after each axis	Passed
Vibration and shock stress for rolling stock equipment	Passed

Commercial data

Product Group	22 (TOPJOB S)
PU (SPU)	100 pcs
Packaging type	Box
Country of origin	CN
GTIN	4045454966782
Customs tariff number	85369010000

Product Classification

UNSPSC	39121410
eCl@ss 10.0	27-14-11-20
eCl@ss 9.0	27-14-11-20
ETIM 9.0	EC000897
ETIM 10.0	EC000897
ECCN	NO US CLASSIFICATION

Environmental Product Compliance

RoHS Compliance Status	Compliant, No Exemption
------------------------	-------------------------

Approvals / Certificates

General approvals



Approval	Standard	Certificate Name
CCA DEKRA Certification B.V.	EN 60947	NTR NL 7962
CSA DEKRA Certification B.V.	C22.2	2130762
KEMA/KEUR DEKRA Certification B.V.	EN 60947	71-125928
UL Underwriters Laboratories Inc.	UL 1059	E45172

Declarations of conformity and manufacturer's declarations



Approval	Standard	Certificate Name
ATEX-Attestation of Conformity WAGO GmbH & Co. KG	-	-
EU-Declaration of Conformity WAGO GmbH & Co. KG	-	-
Railway WAGO GmbH & Co. KG	-	Railway Ready
UK-Declaration of Conformity WAGO GmbH & Co. KG	-	-

Approvals for marine applications



Approval	Standard	Certificate Name
ABS American Bureau of Shipping	EN 60947	24-0152298-PDA
DNV GL Det Norske Veritas, Germanischer Lloyd	-	TAE00001V2
LR Lloyds Register	EN 60947	LR23325966TA
PRS Polski Rejestr Statków	-	TE/1094/880590/23

Approvals for hazardous areas



Approval	Standard	Certificate Name
AEx Underwriters Laboratories Inc.	UL 60079	E185892 (AEx eb IIC resp. Ex eb IIC)
ATEX Physikalisch Technische Bundesanstalt	EN 60079	PTB 11 ATEX 1041 U (II 2 G Ex eb IIC Gb bzw. I M 2 Ex eb I Mb)
CCC CNEX	GB/T 3836.3	2020312313000182 (Ex eb IIC Gb, Ex eb I Mb)
IECEX Physikalisch Technische Bundesanstalt	IEC 60079	IECEX PTB 11.0093U (Ex e IIC Gb or Ex e I Mb)

Downloads

Environmental Product Compliance

Compliance Search	
Environmental Product Compliance 2000-1203	↓

Documentation

Bid Text			
2000-1203	19.02.2019	xml 3.92 KB	↓
2000-1203	07.08.2018	docx 14.60 KB	↓

CAD/CAE-Data

CAD data	
2D/3D Models 2000-1203	↓

CAE data	
EPLAN Data Portal 2000-1203	↓
WSCAD Universe 2000-1203	↓
ZUKEN Portal 2000-1203	↓

1 Compatible Products

1.1 Required Accessories

1.1.1 End plate

1.1.1.1 End plate



Item No.: 2000-1291
End and intermediate plate; 0.7 mm thick; gray

Item No.: 2000-1292
End and intermediate plate; 0.7 mm thick; orange

Item No.: 209-191
Separator for Ex e/Ex i applications; 3 mm thick; 120 mm wide; orange

1.2 Optional Accessories

1.2.1 DIN-rail

1.2.1.1 Mounting accessories



Item No.: 210-196
Aluminum carrier rail; 35 x 8.2 mm; 1.6 mm thick; 2 m long; unslotted; similar to EN 60715; silver-colored

Item No.: 210-198
Copper carrier rail; 35 x 15 mm; 2.3 mm thick; 2 m long; unslotted; according to EN 60715; copper-colored

Item No.: 210-197
Steel carrier rail; 35 x 15 mm; 1.5 mm thick; 2 m long; slotted; similar to EN 60715; silver-colored

Item No.: 210-114
Steel carrier rail; 35 x 15 mm; 1.5 mm thick; 2 m long; unslotted; similar to EN 60715; silver-colored



Item No.: 210-118
Steel carrier rail; 35 x 15 mm; 2.3 mm thick; 2 m long; unslotted; according to EN 60715; silver-colored

Item No.: 210-115
Steel carrier rail; 35 x 7.5 mm; 1 mm thick; 2 m long; slotted; according to EN 60715; "Hole width 18 mm; silver-colored

Item No.: 210-112
Steel carrier rail; 35 x 7.5 mm; 1 mm thick; 2 m long; slotted; according to EN 60715; "Hole width 25 mm; silver-colored

Item No.: 210-113
Steel carrier rail; 35 x 7.5 mm; 1 mm thick; 2 m long; unslotted; according to EN 60715; silver-colored

1.2.2 End plate

1.2.2.1 End plate



Item No.: [209-190](#)

Separator for Ex e/Ex i applications; 3 mm thick; 90 mm wide; orange

1.2.3 Ferrule

1.2.3.1 Ferrule



Item No.: [216-241](#)

Ferrule; Sleeve for 0.5 mm² / 20 AWG; insulated; electro-tin plated; electrolytic copper; gastight crimped; acc. to DIN 46228, Part 4/09.90; white



Item No.: [216-242](#)

Ferrule; Sleeve for 0.75 mm² / 18 AWG; insulated; electro-tin plated; electrolytic copper; gastight crimped; acc. to DIN 46228, Part 4/09.90; gray



Item No.: [216-243](#)

Ferrule; Sleeve for 1 mm² / AWG 18; insulated; electro-tin plated; electrolytic copper; gastight crimped; acc. to DIN 46228, Part 4/09.90; red

1.2.4 Installation

1.2.4.1 Cover



Item No.: [709-156](#)

Cover; Type 3; suitable for cover carrier, type 3; 1 m long; transparent

1.2.4.2 Cover carrier



Item No.: [709-169](#)

Cover carrier; Type 3; incl. fixing/retaining screws and knurled nut; suitable for 279 to 282 and 880 Series rail-mounted terminal blocks; suitable for 264 Series miniature rail-mounted terminal blocks; suitable for 270 Series sensor and actuator terminal blocks; gray

1.2.5 Jumper

1.2.5.1 Jumper



Item No.: [2000-406/020-000](#)

Delta jumper; insulated; light gray



Item No.: [2000-410/000-006](#)

Jumper; 10-way; insulated; blue



Item No.: [2000-410](#)

Jumper; 10-way; insulated; light gray



Item No.: [2000-410/000-005](#)

Jumper; 10-way; insulated; red



Item No.: [2000-402/000-006](#)

Jumper; 2-way; insulated; blue



Item No.: [2000-402](#)

Jumper; 2-way; insulated; light gray



Item No.: [2000-402/000-005](#)

Jumper; 2-way; insulated; red



Item No.: [2000-402/000-018](#)

Jumper; 2-way; insulated; yellow-green



Item No.: [2000-403/000-006](#)

Jumper; 3-way; insulated; blue



Item No.: [2000-403](#)

Jumper; 3-way; insulated; light gray



Item No.: [2000-403/000-005](#)































Jumper; 3-way; insulated; red



Item No.: [2000-404/000-006](#)

Jumper; 4-way; insulated; blue

1.2.5.1 Jumper











 Item No.: 2000-404 Jumper; 4-way; insulated; light gray	 Item No.: 2000-404/000-005 Jumper; 4-way; insulated; red	 Item No.: 2000-405/000-006 Jumper; 5-way; insulated; blue	 Item No.: 2000-405 Jumper; 5-way; insulated; light gray
 Item No.: 2000-405/000-005 Jumper; 5-way; insulated; red	 Item No.: 2000-406/000-006 Jumper; 6-way; insulated; blue	 Item No.: 2000-406 Jumper; 6-way; insulated; light gray	 Item No.: 2000-406/000-005 Jumper; 6-way; insulated; red
 Item No.: 2000-407/000-006 Jumper; 7-way; insulated; blue	 Item No.: 2000-407 Jumper; 7-way; insulated; light gray	 Item No.: 2000-407/000-005 Jumper; 7-way; insulated; red	 Item No.: 2000-408/000-006 Jumper; 8-way; insulated; blue
 Item No.: 2000-408 Jumper; 8-way; insulated; light gray	 Item No.: 2000-408/000-005 Jumper; 8-way; insulated; red	 Item No.: 2000-409/000-006 Jumper; 9-way; insulated; blue	 Item No.: 2000-409 Jumper; 9-way; insulated; light gray
 Item No.: 2000-409/000-005 Jumper; 9-way; insulated; red	 Item No.: 2000-440 Jumper; from 1 to 10; insulated; light gray	 Item No.: 2000-433/000-006 Jumper; from 1 to 3; insulated; blue	 Item No.: 2000-433 Jumper; from 1 to 3; insulated; light gray
 Item No.: 2000-433/000-005 Jumper; from 1 to 3; insulated; red	 Item No.: 2000-434 Jumper; from 1 to 4; insulated; light gray	 Item No.: 2000-435 Jumper; from 1 to 5; insulated; light gray	 Item No.: 2000-436 Jumper; from 1 to 6; insulated; light gray
 Item No.: 2000-437 Jumper; from 1 to 7; insulated; light gray	 Item No.: 2000-438 Jumper; from 1 to 8; insulated; light gray	 Item No.: 2000-439 Jumper; from 1 to 9; insulated; light gray	 Item No.: 2000-405/011-000 Star point jumper; 3-way; insulated; light gray
 Item No.: 210-103 Wire commoning chain; insulated; black	 Item No.: 210-123 Wire commoning chain; insulated; blue		

1.2.6 Marking

1.2.6.1 Group marker carrier

 Item No.: 2009-191 Group marker carrier; gray

1.2.6.2 Marker

 Item No.: 793-3501 WMB marking card; as card; plain; snap-on type; white	 Item No.: 2009-113/000-006 WMB-Inline; for Smart Printer; 2300 pieces on roll; plain; snap-on type; blue	 Item No.: 2009-113/000-007 WMB-Inline; for Smart Printer; 2300 pieces on roll; plain; snap-on type; gray	 Item No.: 2009-113/000-023 WMB-Inline; for Smart Printer; 2300 pieces on roll; plain; snap-on type; green
 Item No.: 2009-113/000-017 WMB-Inline; for Smart Printer; 2300 pieces on roll; plain; snap-on type; light green	 Item No.: 2009-113/000-012 WMB-Inline; for Smart Printer; 2300 pieces on roll; plain; snap-on type; orange	 Item No.: 2009-113/000-005 WMB-Inline; for Smart Printer; 2300 pieces on roll; plain; snap-on type; red	 Item No.: 2009-113/000-024 WMB-Inline; for Smart Printer; 2300 pieces on roll; plain; snap-on type; violet
 Item No.: 2009-113 WMB-Inline; for Smart Printer; 2300 pieces on roll; plain; snap-on type; white	 Item No.: 2009-113/000-002 WMB-Inline; for Smart Printer; 2300 pieces on roll; plain; snap-on type; yellow		

1.2.6.3 Marking strip



Item No.: 2009-110

Marking strips; for Smart Printer; on reel; not stretchable; plain; snap-on type; white

1.2.7 Protective warning marker

1.2.7.1 Cover



Item No.: 2000-115

Protective warning marker; for 5 terminal blocks; with high-voltage symbol, black; yellow

1.2.8 Push-in type wire jumper

1.2.8.1 Jumper



Item No.: 2009-404

Push-in type wire jumper; 0.75 mm²; insulated; 110 mm long; gray



Item No.: 2009-406

Push-in type wire jumper; 0.75 mm²; insulated; 250 mm long; gray



Item No.: 2009-402

Push-in type wire jumper; 0.75 mm²; insulated; 60 mm long; gray

1.2.9 Screwless end stop

1.2.9.1 Mounting accessories



Item No.: 249-117

Screwless end stop; 10 mm wide; for DIN-rail 35 x 15 and 35 x 7.5; gray



Item No.: 249-116

Screwless end stop; 6 mm wide; for DIN-rail 35 x 15 and 35 x 7.5; gray

1.2.10 Test and measurement

1.2.10.1 Testing accessories



Item No.: 2000-560

Modular TOPJOB®S connector; modular; for jumper contact slot; 10-pole; gray



Item No.: 2000-552

Modular TOPJOB®S connector; modular; for jumper contact slot; 2-pole; gray



Item No.: 2000-553

Modular TOPJOB®S connector; modular; for jumper contact slot; 3-pole; gray



Item No.: 2000-554

Modular TOPJOB®S connector; modular; for jumper contact slot; 4-pole; gray



Item No.: 2000-555

Modular TOPJOB®S connector; modular; for jumper contact slot; 5-pole; gray



Item No.: 2000-556

Modular TOPJOB®S connector; modular; for jumper contact slot; 6-pole; gray



Item No.: 2000-557

Modular TOPJOB®S connector; modular; for jumper contact slot; 7-pole; gray



Item No.: 2000-558

Modular TOPJOB®S connector; modular; for jumper contact slot; 8-pole; gray



Item No.: 2000-559

Modular TOPJOB®S connector; modular; for jumper contact slot; 9-pole; gray



Item No.: 2000-549

Spacer module; modular; e.g., for bridging commoned terminal blocks; gray



Item No.: 2009-174

Test plug adapter; for 4 mm Ø test plugs; for testing TOPJOB®S rail-mounted terminal blocks; gray



Item No.: 210-136

Test plug; 2 mm Ø; with 500 mm cable; red

1.2.10.1 Testing accessories



Item No.: 2009-182

Testing tap; for max. 2.5 mm²; tool-free connection for individual test wires 0.08 - 2.5 mm; gray

Item No.: 2000-511

TOPJOB®S L-type test plug module; modular; for jumper contact slot; 1-pole; gray

Item No.: 2000-510

TOPJOB®S L-type test plug module; modular; for jumper contact slot; gray

1.2.11 Tool

1.2.11.1 Operating tool



Item No.: 210-719

Operating tool; Blade: 2.5 x 0.4 mm; with a partially insulated shaft

Item No.: 210-648

Operating tool; Blade: 2.5 x 0.4 mm; with a partially insulated shaft; angled; short

Item No.: 210-647

Operating tool; Blade: 2.5 x 0.4 mm; with a partially insulated shaft; multicoloured

Installation Notes

Conductor termination



All conductor types at a glance

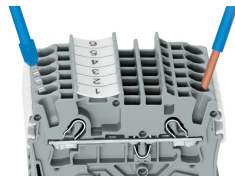

Push-in termination of solid and ferruled conductors

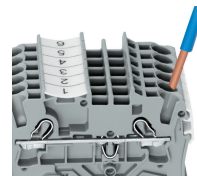

Inserting a conductor via push-in termination:

Solid conductors with cross-sections from either one size above, or up to two sizes below, the rated cross-section can be simply pushed in – no tools needed.

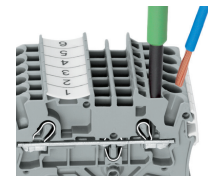

Inserting a conductor via operating tool:

Connecting fine-stranded conductors without ferrules, or small cross-sectional conductors that cannot be pushed in, is performed similarly to the original CAGE CLAMP® – just use an operating tool.

Advantage:

To open the clamp, the operating tool is inserted vertically. The conductor entry is less than 15 degrees for easier wiring.

Commoning

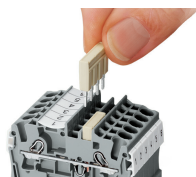

Insert push-in type jumper bar and push down until it hits backstop.

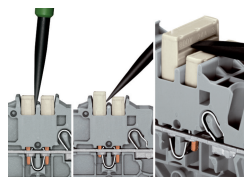

Removing a push-in type jumper bar:

Insert the operating tool between the jumper and partition wall of the dual jumper slots, then lift up the jumper.

Place the operating tool in the center of jumpers for up to five contacts (see above), or alternately on both sides for jumpers with more than five contacts.

Commoning

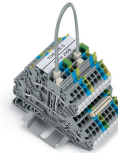
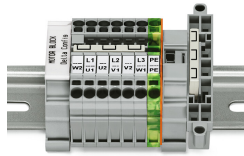
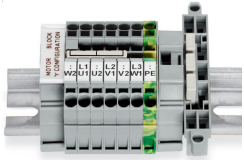

This star point jumper has been specially developed to create a "star point" and is used on motor terminal boards equipped with Rail-Mount Terminal Blocks TOPJOB® S.

This delta jumper has been specially developed to create a delta configuration and is used on motor terminal boards equipped with rail-mount terminal blocks TOPJOB® S.

Push down the wire jumper (2009-402) until fully inserted. For rewiring, lift the jumper with an operating tool at the notch provided for this purpose on the jumper.

Testing

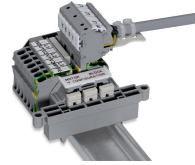
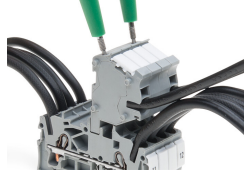
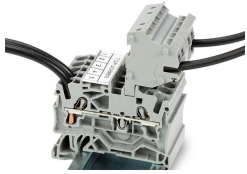

The modular TOPJOB® S connectors also connect conductors of the same size as the terminal blocks being used.

TOPJOB® S Connectors with a 2 mm Ø test socket for testing voltage via 2-pole voltage tester

Rail-mount terminal block assembly for electric motor wiring

Test plug adapter (Item No. 2009-174, CAT I) for 4 mm Ø plugs – compatible with 2000 to 2016 Series



Testing tap (Item No. 2009-182) for tool-free connection of test cables up to 2.5 mm² (12 AWG) – compatible with 2000 to 2016 Series

Marking

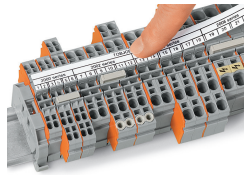
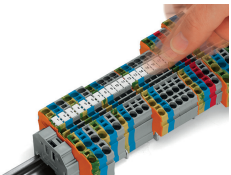

Snapping WMB Inline markers into marker slots.

TOPJOB® S 2009-193 Group Marker Carrier (equipped with a marking strip) for all 2001 to 2016 Series TOPJOB® S Rail-Mount Terminal Blocks
Do not use on an end plate!

Ex application

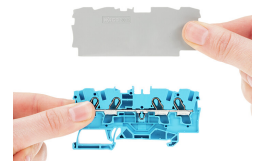
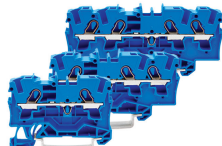
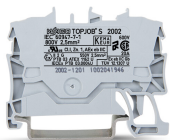

Through terminal blocks with blue insulated housing are suitable for Ex i applications.

All through and ground conductor terminal blocks are suitable for Ex e II applications.

Separator plate for Ex e/Ex i applications
An end plate must be applied to the terminal block located directly behind an Ex e/Ex i separator plate.

Ex application

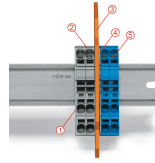

Ex e II/Ex i terminal strip

Note:

The movable feet of terminal blocks and separator plates must face the same direction.

A separator plate is located between the Ex e II and Ex i terminal strip.

End plate

Ex e II terminal blocks

Separator plate for Ex e/Ex i applications

End plate

Ex i terminal blocks

According to EN 50020, a minimum distance of 50 mm must be kept between live parts of Ex e and Ex i circuits. The use of Ex e/Ex i separators is a space-saving solution when Ex e and Ex i terminal blocks are mounted on a common DIN-rail.