

KSC10 Series

Sealed Tactile Switches for SMT

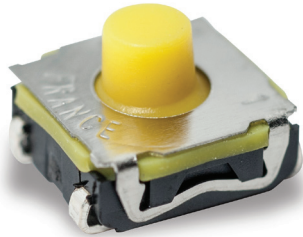

KSC10 soft actuator 4.9 mm high

Specifications

Function	Momentary action
Contact Arrangement	1 make contact = SPST, N.O.
Terminals	J bend & Gullwing type for SMT
Sealing	IP67
Packaging	Switches delivered on continuous tape & reels of 1,000 pieces Dimensions according to EIA RS-481/ IEC 60286-3 standard External diameter 330 ± 2 mm

Description

The KSC10 series sealed tactile switch for SMT gives users a positive adaptable tactile feeling – and its small size is ideal for products made specifically for industrial, consumer, automotive and instrumentation applications. The KSC10 is an IP67 rated, 4.9 mm high soft actuator switch.

Features & Benefits

- Positive adaptable tactile feeling
- J or G terminations
- Soft actuator 4.9mm high
- IP67

Applications

- Industrial electronics
- Instrumentation
- Automotive
- Consumer

Dimensions

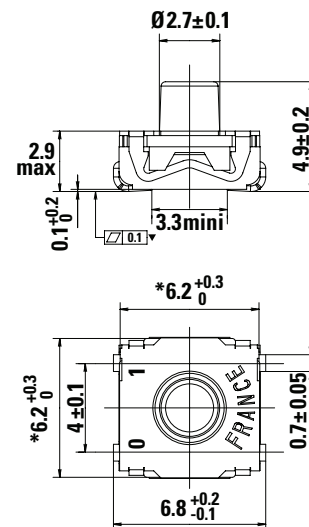

KSC10 Series

Sealed Tactile Switches for SMT



Mechanical Characteristics

Part #	Operating Force FA (Newtons)	Operating Life (operations)	Travel (mm)
KSC1001	1.45 ± 0.55	5,000,000	0.45 ± 0.25

Soldering Profile

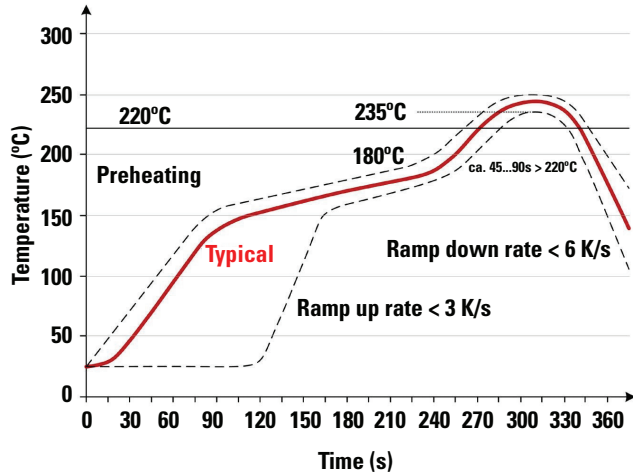

Note: Up to 2 reflow cycles in accordance with the above temperature profile

Soldering process: Depending on the application, this component is suited to the following methods:

- Terminals being silver or gold plated over a nickel barrier, the use of slightly activated flux is suitable.
- Lead free soldering process in accordance with the definition on the left.

J Terminations (mm)

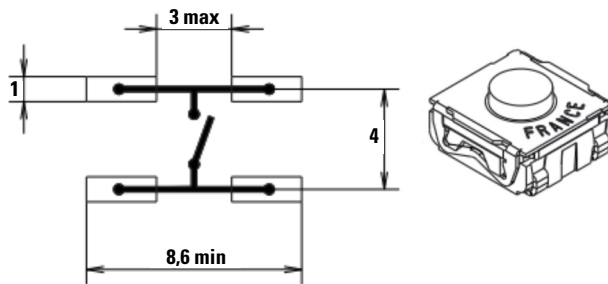

G Terminations (mm)

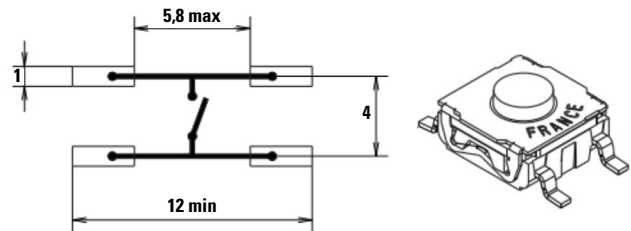

Tape & Reel

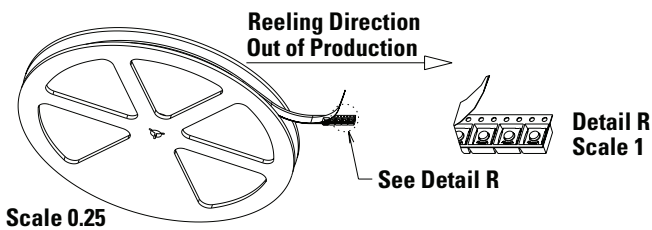

Packaging Details

Type	Tape & reel
Number of Parts in Packaging	2,000
Other Information	Tape and reel per EIA 481
Transport Conditions	According to specification NF H00-060

KSC10 Series

Sealed Tactile Switches for SMT



Ordering Number

Our easy build-a-switch concept allows you to mix and match options to create the switch you need. To order, select desired option from each category and place it in the appropriate box. For any part number different from those listed above, please consult your local representative.

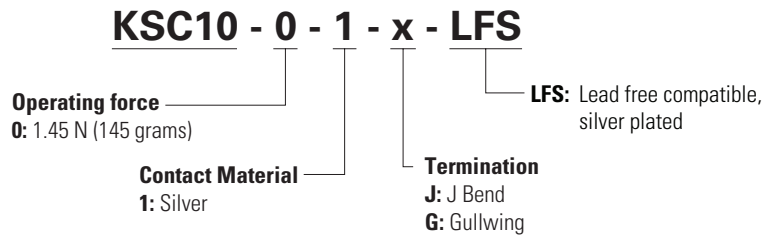

Note: KSC10 offered with yellow actuator as standard, hardness 55 Shore

Liability Limitation

This datasheet does not provide enough information for applications that require a certain level of quality or safety such as automotive, medical systems, or safety equipment. Please contact customer service for the contractual specification package.

Disclaimer Notice - Information furnished is believed to be accurate and reliable. However, users should independently evaluate the suitability of and test each product selected for their own applications. Littelfuse products are not designed for, and may not be used in, all applications. Read complete Disclaimer Notice at <http://www.littelfuse.com/disclaimer-electronics>.