

Leaded Power Chokes AFDI Series

Automotive
AEC-Q200

RoHS Compliant
Halogen Free
REACH Compliant



Part Numbering

A	FDI	00	303012	1R0	M	01
Grade	Series Name	Control Code	Dimensions Code (mm)	Inductance (uH)	Tolerance	Internal Code
			111109 12x12x9~9.5	1R0 1.0	M ±20%	R1
			121210 12x12x10	100 10		04
			131210 13x12x8~12	101 100		06
			161311 15.5x13x10~12			
			191909 19.5x8.5			
			212010 20.5x9.5			
			282811 28x10.5			
			303012 30x12.7			

Please be sure to request approval specifications that provide further details of the products. Kindly note that the content of these specifications are subject to change or may be discontinued without prior notice. This product may not be designed/used in medical or high risk applications without Chilisin approval. Please contact our sales department before ordering.

AFDI00111109 Type

■ Dimensions

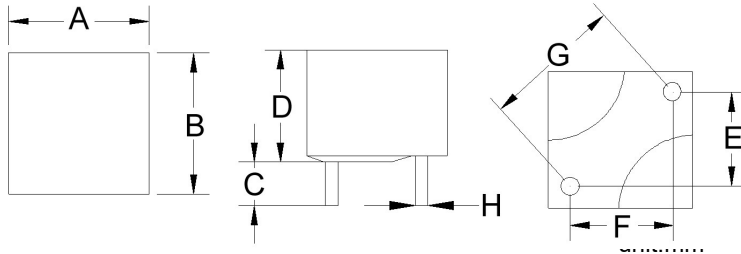

■ Recommended Land Pattern

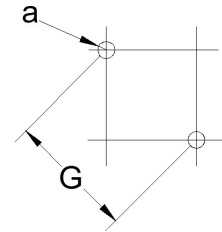

unit:mm

■ Electrical Characteristics

Part No.	L (uH)	Test Freq.	RDC(mΩ) Typ(Max)	Isat (A)Typ.	Irms (A)Typ.	Tol. (±%)	Dimensions								
							A Max	B Max	C±0.5	D Max	E±0.5	F±0.5	G±0.5	H±0.1	a
AFDI001111091R0M05	1	100kHz,1V	1.03(1.5)	42	35	20	12	12	3.4	9	7.3	6	9.4	1.5	1.9
AFDI001111092R5M05	2.5	100kHz,1V	2.37(2.6)	25	27	20	12	12	3.4	9.5	6.6	6.6	9.3	1.2	1.6

Note: When ordering, please specify tolerance code. Tolerance: M=±20%

1. Customized Specifications are welcome
2. Operating temperature range -50°C ~ 155°C (Including self - temperature rise)
3. Isat for Inductance drop 20% from its value without current
4. Irms for a 40°C temprature rise from 25°C ambient with current
5. Measure Equipment:

L: WK4237
RDC: CHEN HWA502
Isat: WK3260B/ 3265
Irms: WK3260B/ 3265

AFDI00111109 Type

Characteristics Graph

Inductance vs. DC Current

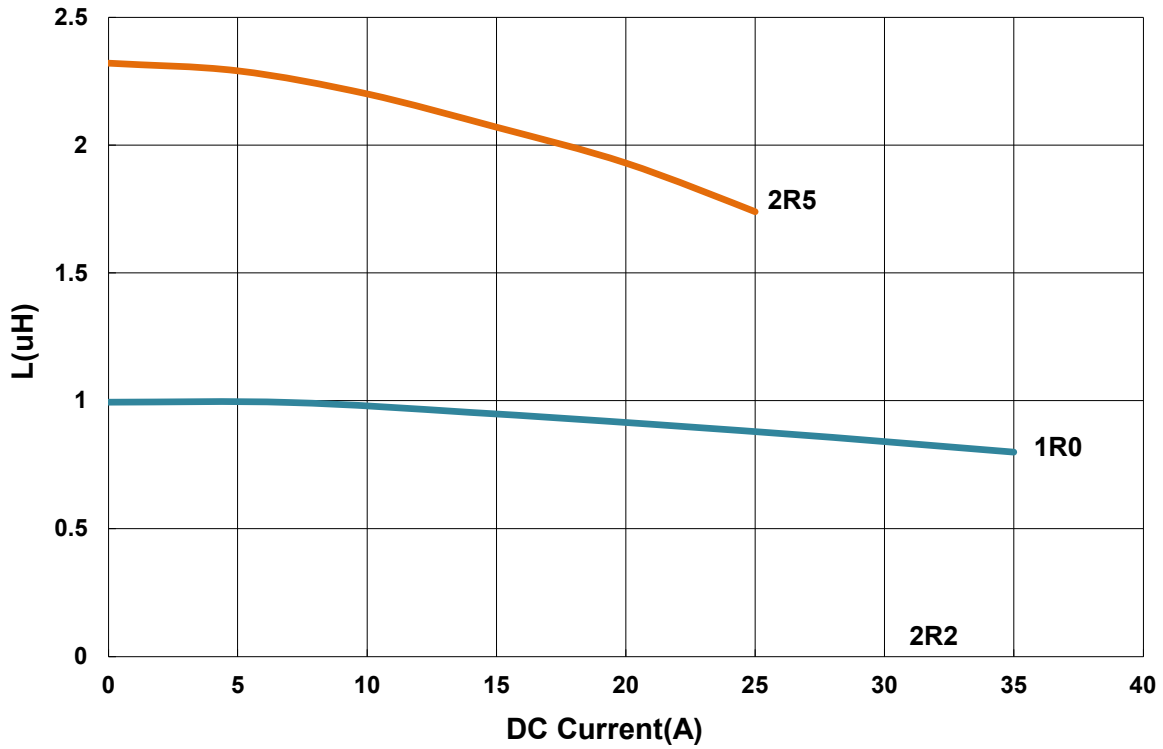

Temperature Change vs. DC Current

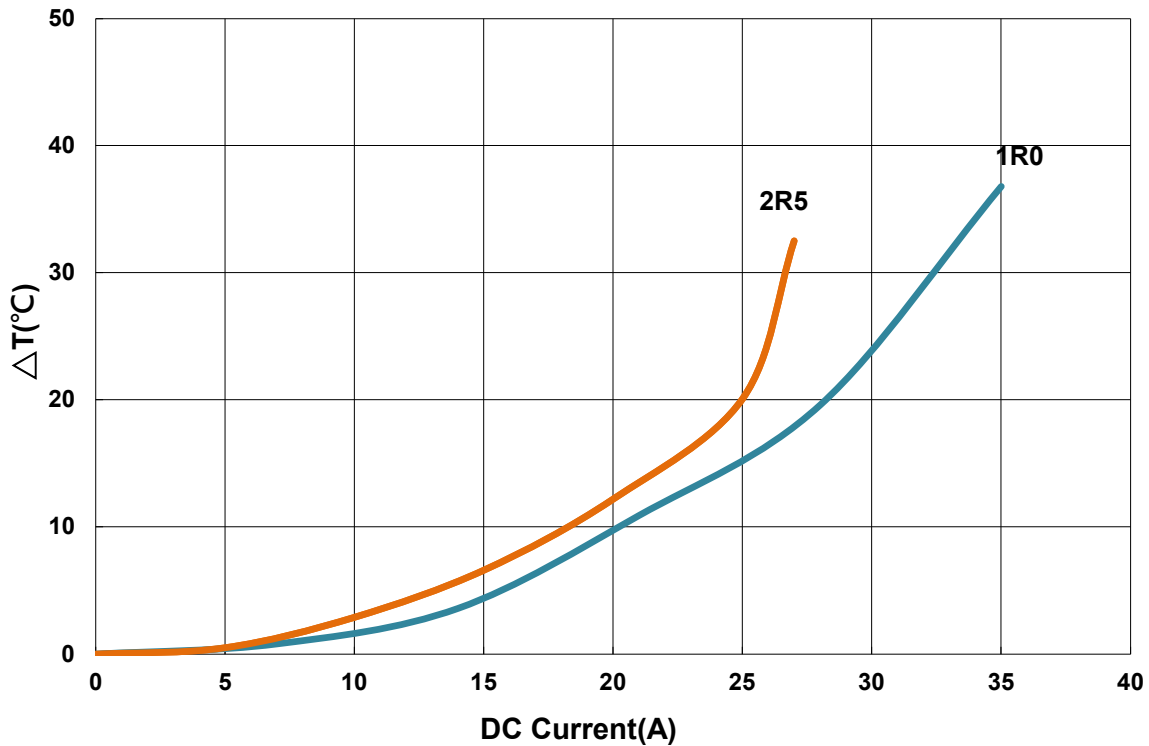

Please be sure to request approval specifications that provide further details of the products. Kindly note that the content of these specifications are subject to change or may be discontinued without prior notice. This product may not be designed/used in medical or high risk applications without Chilisin approval. Please contact our sales department before ordering.

AFDI00121210 Type

■ Dimensions

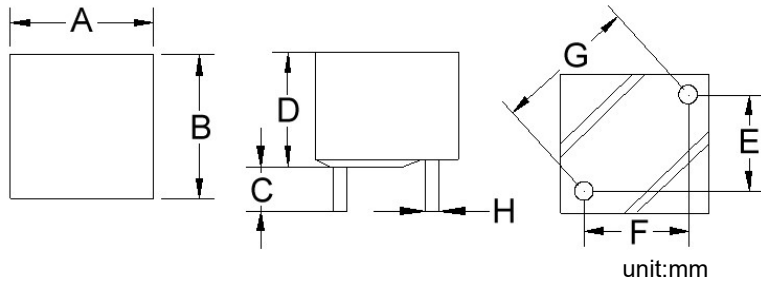

■ Recommended Land Pattern

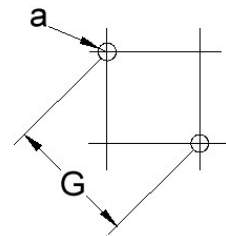

■ Electrical Characteristics

Part No.	L (uH)	Test Freq.	RDC(mΩ) Typ(Max)	Isat (A)Typ.	Irms (A)Typ.	Tol. (±%)	Dimensions								
							A±0.5	B±0.5	C±0.5	D Max	E±0.5	F±0.5	G±0.5	H±0.1	a
AFDI001212104R7M01	4.7	100kHz,1V	4.51(6)	16	15	20	12Max	12Max	3.4	10	7	7	10	1.1	1.5
AFDI001212108R2M01	8.2	100kHz,1V	7.92(9.3)	8	11	20	12	12	3.4	10	7	7	10	1	1.4

Note: When ordering, please specify tolerance code. Tolerance: M=±20%

1. Customized Specifications are welcome
2. Operating temperature range -50°C~155°C(Including self - temperature rise)
3. Isat for Inductance drop 20% from its value without current
4. Irms for a 40°C temperature rise from 25°C ambient with current
5. Measure Equipment:
 L: WK4237
 RDC: CHEN HWA502
 Isat: WK3260B/ 3265
 Irms: WK3260B/ 3265

AFDI00121210 Type

Characteristics Graph

Inductance vs. DC Current

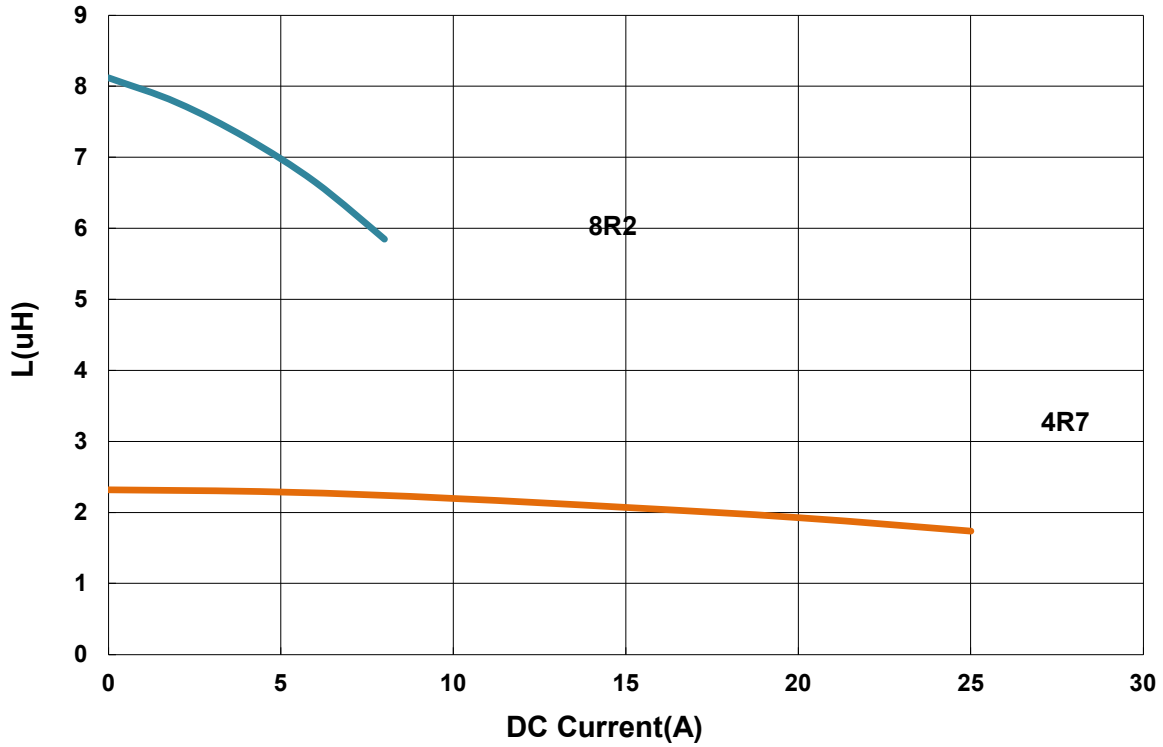

Temperature Change vs. DC Current

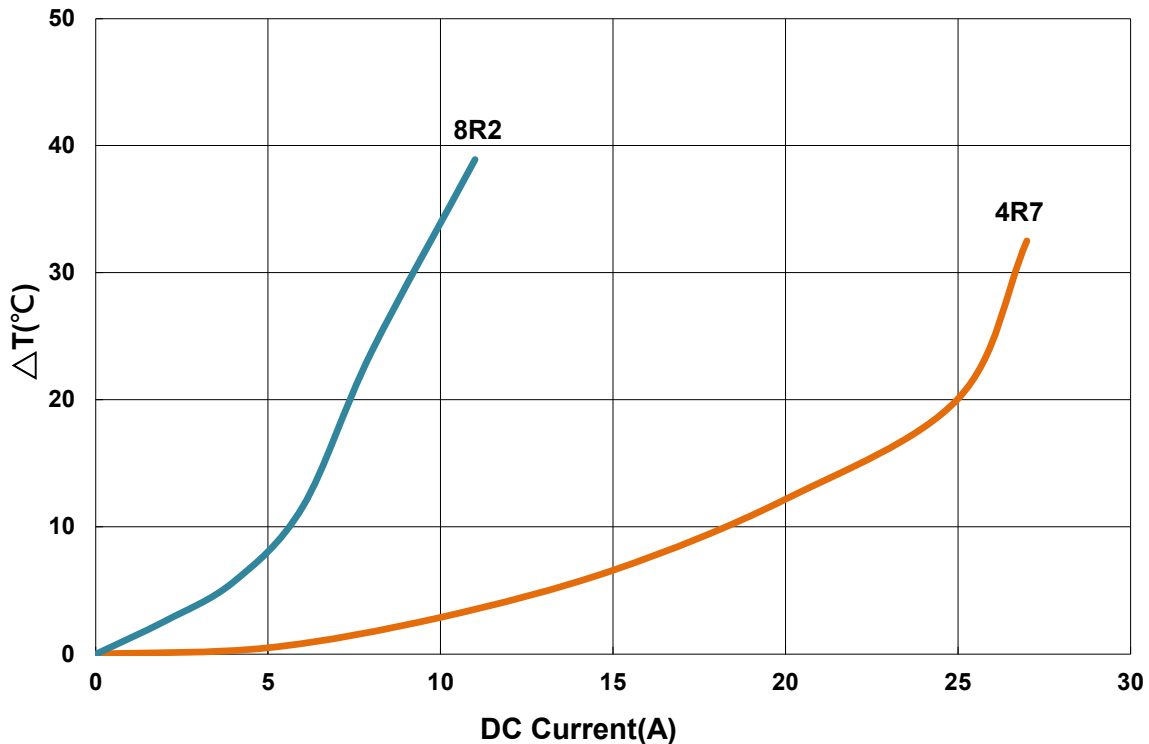

Please be sure to request approval specifications that provide further details of the products. Kindly note that the content of these specifications are subject to change or may be discontinued without prior notice. This product may not be designed/used in medical or high risk applications without Chilisin approval. Please contact our sales department before ordering.

AFDI00131210 Type

■ Dimensions

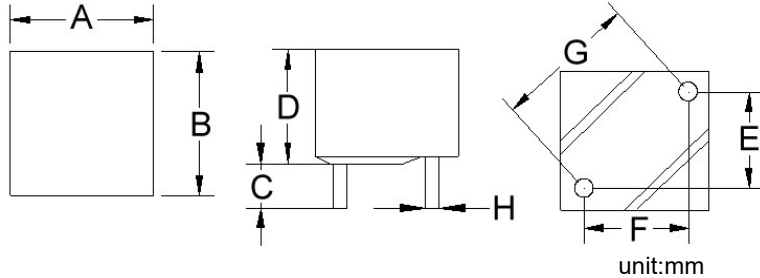

unit:mm

■ Recommended Land Pattern

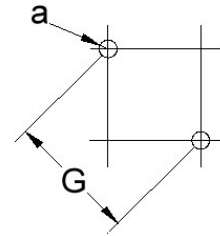

unit:mm

■ Electrical Characteristics

Part No.	L (uH)	Test Freq.	RDC(mΩ) Typ(Max)	Isat (A)Typ.	Irms (A)Typ.	Tol. (±%)	Dimensions								
							A±0.5	B±0.5	C±0.5	D Max	E±0.5	F±0.5	G±0.5	H±0.1	a
AFDI00131210R60M01	0.6	100kHz,1V	0.88(1)	45	35	20	13	12	3.4	10	6.6	7.6	10	1.5	1.9
AFDI00131210R68M01	0.68	100kHz,1V	0.83(0.88)	50	45	30	12	13	3.5	8	7.6	6.5	10	1.5±0.2	1.9
AFDI001312101R0M01	1	100kHz,1V	1.12(1.32)	40	30	20	13	12	3.4	10	6.6	7.6	10	1.5	1.9
AFDI001312101R5M01	1.5	100kHz,1V	1.81(2)	40	26	20	13	12	3.4	11	6.6	7.6	10	1.2	1.6
AFDI001312102R2M01	2.2	100kHz,1V	2.44(2.8)	20	20	20	13	12	3.4	10.5	6.6	7.6	10	1.3	1.7
AFDI001312102R5M01	2.5	100kHz,1V	2.44(2.8)	34	28	20	13	12	3.4	10.5	6.6	7.6	10	1.2	1.6
AFDI001312103R3M01	3.3	100kHz,1V	2.55(4)	23	19	20	13	12	3.4	12	6.6	7.6	10	1.2	1.6
AFDI001312104R7M01	4.7	100kHz,1V	4.28(6)	20	20	20	13	12	3.4	12	6.6	7.6	10	1.3	1.7

Note: When ordering, please specify tolerance code. Tolerance: M=±20%

1. Customized Specifications are welcome
2. Operating temperature range -50°C~155°C(Including self - temperature rise)
3. Isat for Inductance drop 20% from its value without current
4. Irms for a 40°C temprature rise from 25°C ambient with current
5. Measure Equipment:
L: WK4237
RDC: CHEN HWA502
Isat: WK3260B/ 3265
Irms: WK3260B/ 3265

AFDI00131210 Type

Characteristics Graph

Inductance vs. DC Current

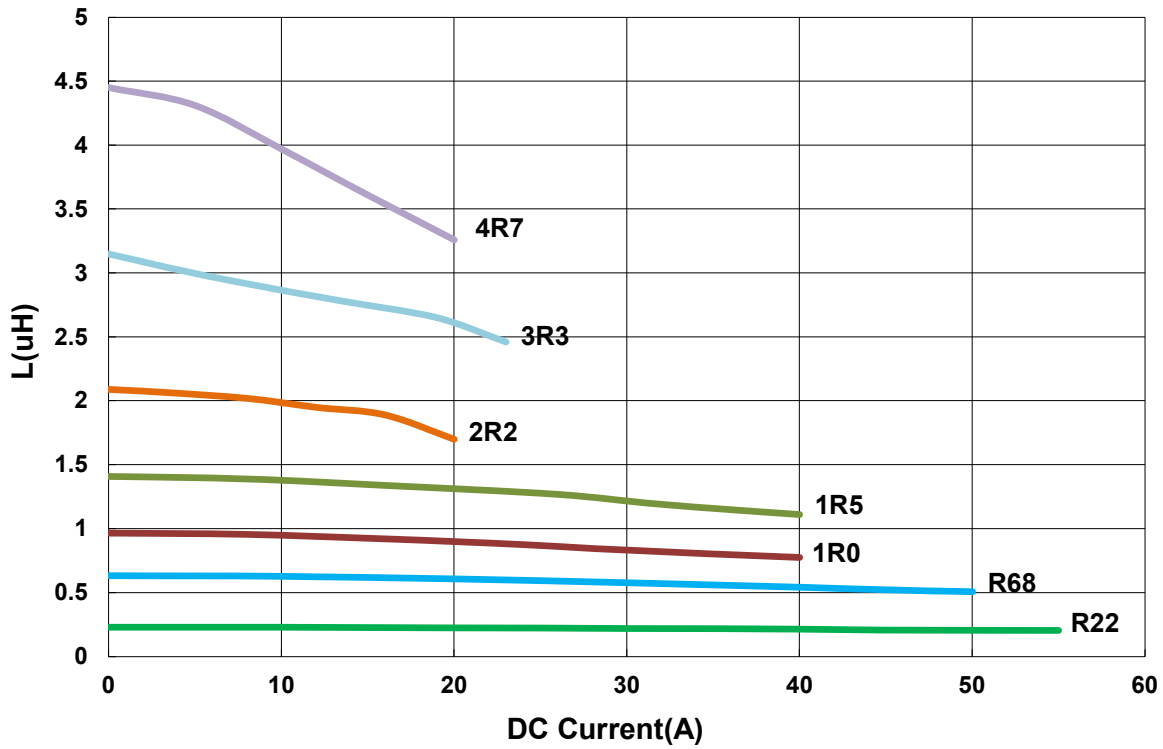

Inductance vs. DC Current

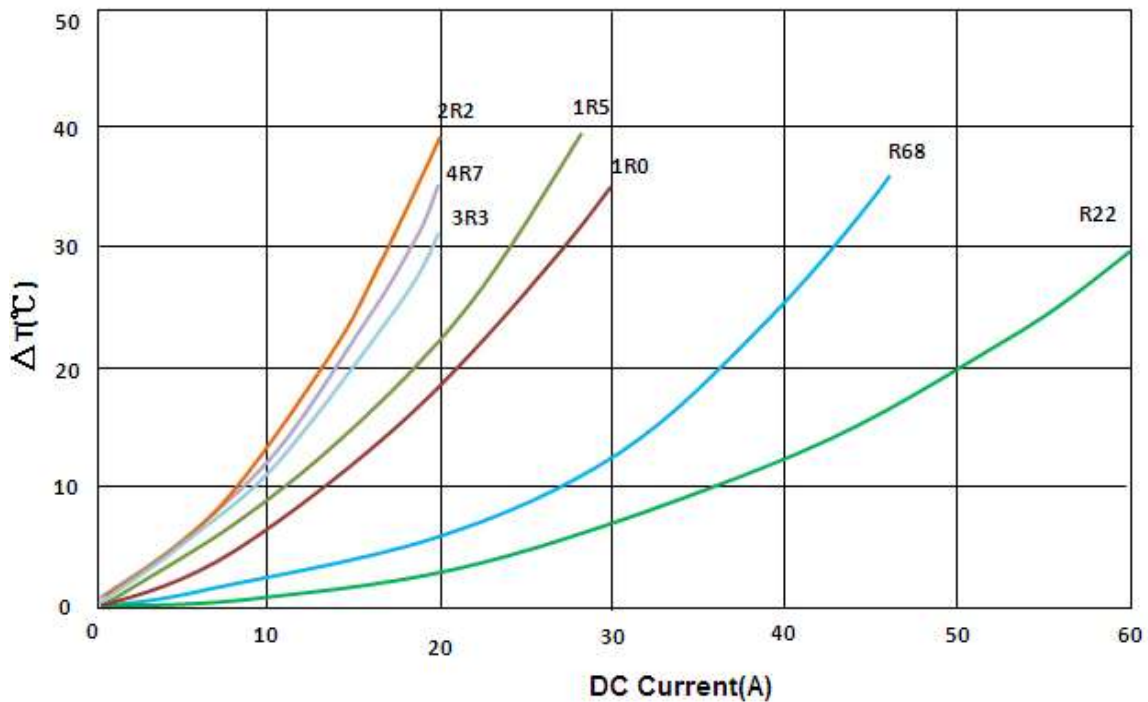

Please be sure to request approval specifications that provide further details of the products. Kindly note that the content of these specifications are subject to change or may be discontinued without prior notice. This product may not be designed/used in medical or high risk applications without Chilisin approval. Please contact our sales department before ordering.

AFDI00161311 Type

■ Dimensions

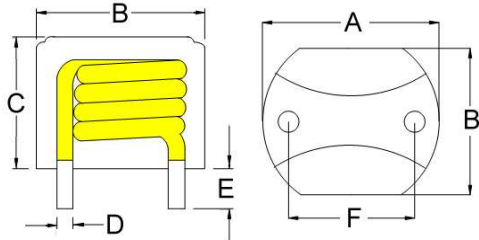

unit:mm

■ Recommended Land Pattern

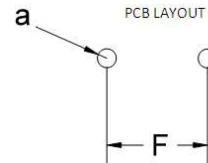

unit:mm

■ Electrical Characteristics

Part No.	L (uH)	Test Freq.	RDC(mΩ) Typ(Max)	Isat (A)Typ.	Irms (A)Typ.	Tol. (±%)	Dimensions						
							A±0.5	B±0.5	C Max	D±0.1	E±0.5	F±0.5	a
AFDI001613113R3M01	3.3	100kHz,1V	3.18(3.7)	35	25	20	15.5	13	11	1.2	3.4	10	1.6
AFDI001613116R4M01	6.4	100kHz,1V	5.6(6.5)	20	14	20	15.5	13	12	1.2	4	10	1.6
AFDI001613116R8M01	6.8	100kHz,1V	5.83(6.5)	20	14	20	15.5	13	12	1.2	4	10	1.6
AFDI00161311120M01	12	100kHz,1V	10.02(12)	15	12	20	15.5	13	10	0.9	4	10	1.3
AFDI00161311220M01	22	100kHz,1V	16.97(25)	9	9	20	15.5	13	10.4±0.4	0.8	4	10	1.2

Note: When ordering, please specify tolerance code. Tolerance: M=±20%

1. Customized Specifications are welcome
2. Operating temperature range -50°C~155°C(Including self - temperature rise)
3. Isat for Inductance drop 20% from its value without current
4. Irms for a 40°C temprature rise from 25°C ambient with current
5. Measure Equipment:

L: WK4237
RDC: CHEN HWA502
Isat: WK3260B/ 3265
Irms: WK3260B/ 3265

AFDI00161311 Type

Characteristics Graph

Inductance vs. DC Current

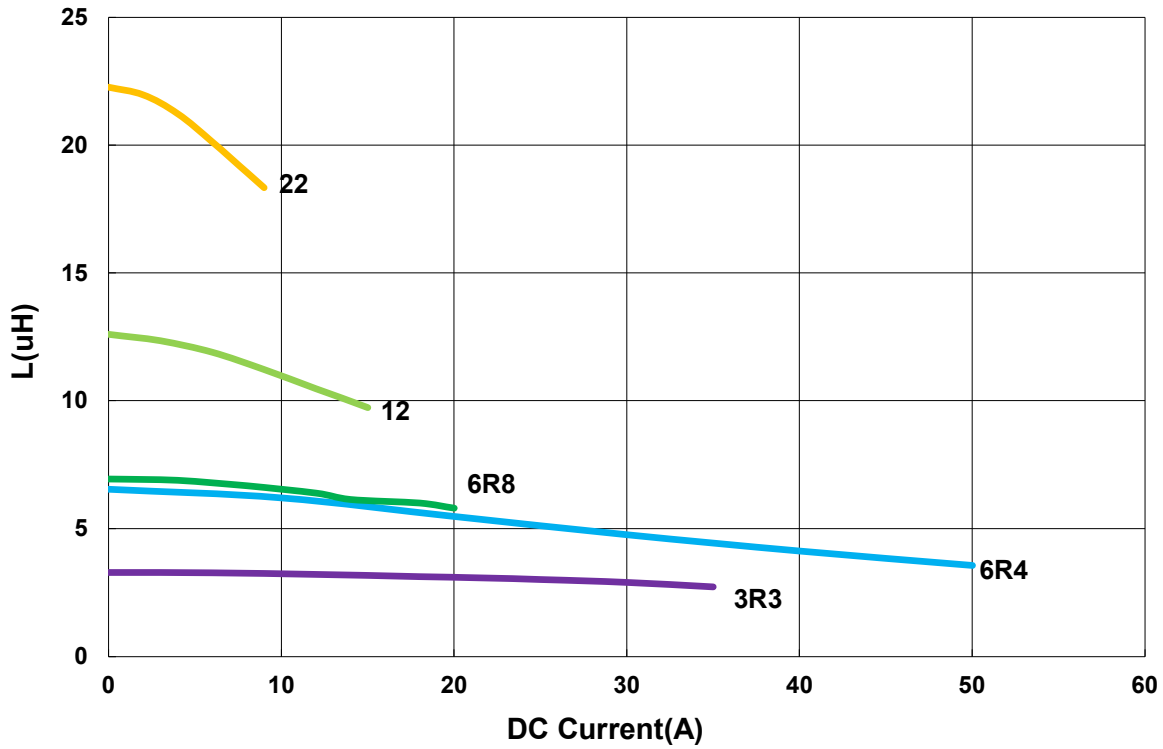

Temperature Change vs. DC Current

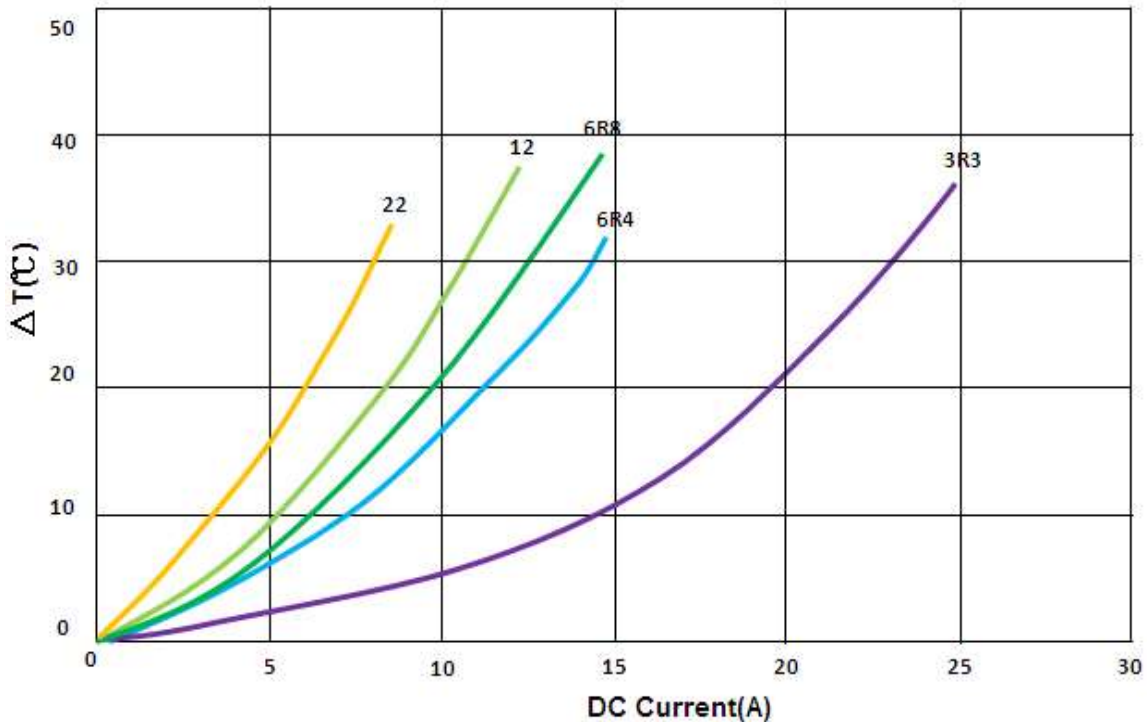

Please be sure to request approval specifications that provide further details of the products. Kindly note that the content of these specifications are subject to change or may be discontinued without prior notice. This product may not be designed/used in medical or high risk applications without Chilisin approval. Please contact our sales department before ordering.

AFDI00191909 Type

■ Dimensions

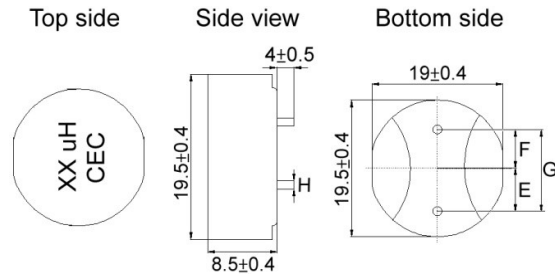

0.47uH~10uH

■ Recommended Land Pattern

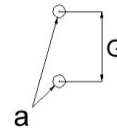

unit:mm

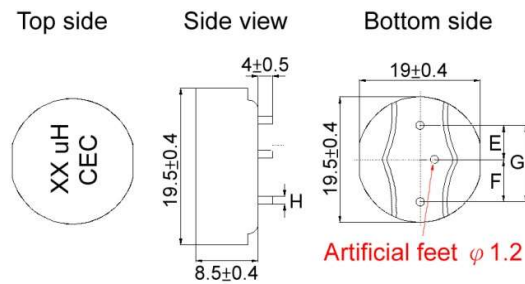

22uH~100uH

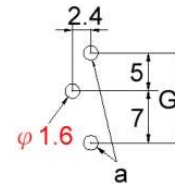

unit:mm

■ Electrical Characteristics

Part No.	L (uH)	Test Freq.	RDC(mΩ) Max(Typ)	Isat (A)Typ.	Irms (A)Typ.	Tol. (±%)	Marking	Dimensions				
								E	F	G	H	a
AFDI00191909R47M06	0.47	100kHz,1V	0.45(0.33)	75	80	20	0.47 uH	6±0.5	6±0.5	12±0.5	2.0±0.1	2.4
AFDI001919091R0M06	1	100kHz,1V	0.86(0.75)	44	54	20	1.0 uH	6±0.5	6±0.5	12±0.5	1.8±0.1	2.2
AFDI001919092R2M06	2.2	100kHz,1V	1.52(1.32)	38	45	20	2.2 uH	6±0.5	6±0.5	12±0.5	1.8±0.1	2.2
AFDI001919093R3M06	3.3	100kHz,1V	2.3(1.95)	33	39	20	3.3 uH	5.5±0.5	6.5±0.5	12±0.5	1.6±0.1	2
AFDI001919094R7M06	4.7	100kHz,1V	3.2(2.91)	27	31	20	4.7 uH	5±0.5	7±0.5	12±0.5	1.4±0.1	1.8
AFDI001919096R8M06	6.8	100kHz,1V	4.1(3.85)	22	30	20	6.8 uH	5±0.5	7±0.5	12±0.5	1.4±0.1	1.8
AFDI001919098R2M06	8.2	100kHz,1V	6(4.85)	20	24	20	8.2 uH	5±0.5	7±0.5	12±0.5	1.3±0.1	1.7
AFDI00191909100M06	10	100kHz,1V	7(5.85)	18	22	20	10 uH	5±0.5	7±0.5	12±0.5	1.3±0.1	1.7
AFDI00191909220M06	22	100kHz,1V	13(12.06)	13	15	20	22 uH	5±0.5	7±0.5	12±0.5	1.0±0.1	1.4
AFDI00191909330M06	33	100kHz,1V	22.8(20.78)	11	10	20	33 uH	5±0.5	7±0.5	12±0.5	0.9±0.1	1.3
AFDI00191909470M06	47	100kHz,1V	35.2(32)	8	8	20	47 uH	5±0.5	7±0.5	12±0.5	0.8±0.1	1.2
AFDI00191909680M06	68	100kHz,1V	46(40.5)	7	7.5	20	68 uH	5±0.5	7±0.5	12±0.5	0.8±0.1	1.2
AFDI00191909820M06	82	100kHz,1V	56(50.2)	7	6	20	82 uH	5±0.5	7±0.5	12±0.5	0.7±0.1	1.1
AFDI00191909101M06	100	100kHz,1V	62(56.5)	6	6	20	100 uH	5±0.5	7±0.5	12±0.5	0.7±0.1	1.1

Note: When ordering, please specify tolerance code. Tolerance: M=±20%

1. Customized Specifications are welcome
2. Operating temperature range -50°C~155°C(Including self - temperature rise)
3. Isat for Inductance drop 20% from its value without current
4. Irms for a 40°C temperature rise from 25°C ambient with current
5. Measure Equipment:

L: WK4237
RDC: CHEN HWA502
Isat: WK3260B/ 3265
Irms: WK3260B/ 3265

Please be sure to request approval specifications that provide further details of the products. Kindly note that the content of these specifications are subject to change or may be discontinued without prior notice. This product may not be designed/used in medical or high risk applications without Chilisin approval. Please contact our sales department before ordering.

AFDI00191909 Type

Characteristics Graph

Inductance vs. DC Current

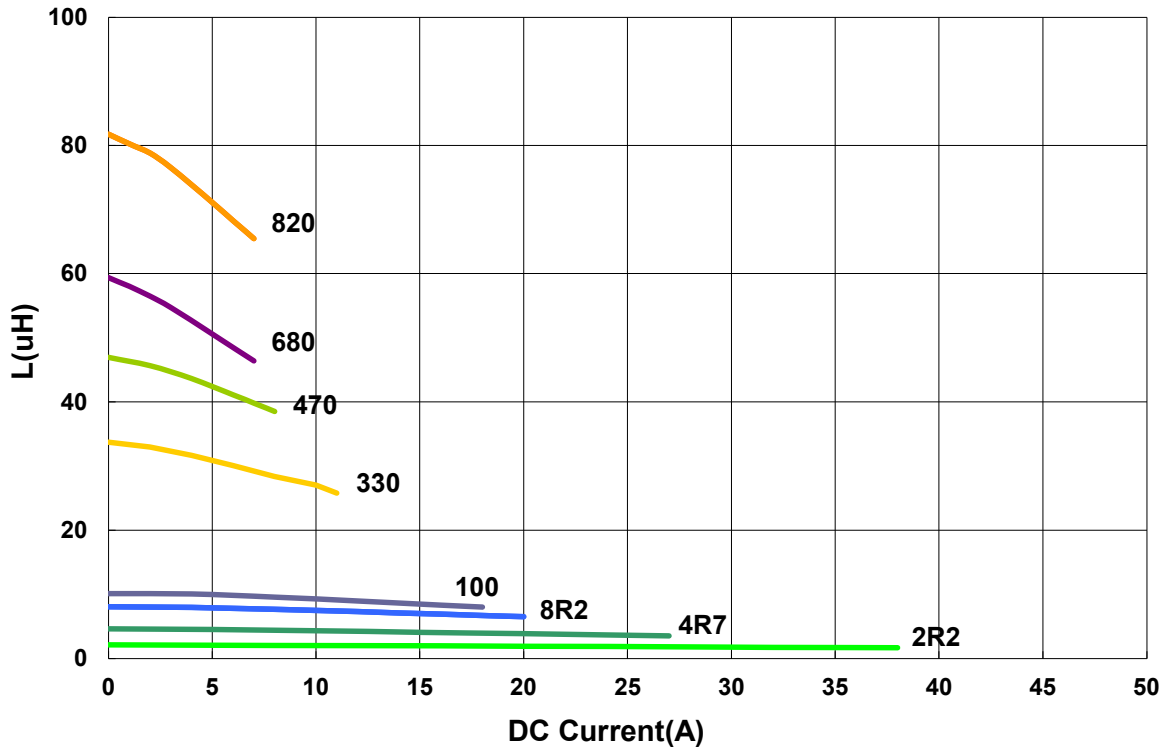

Temperature Change vs. DC Current

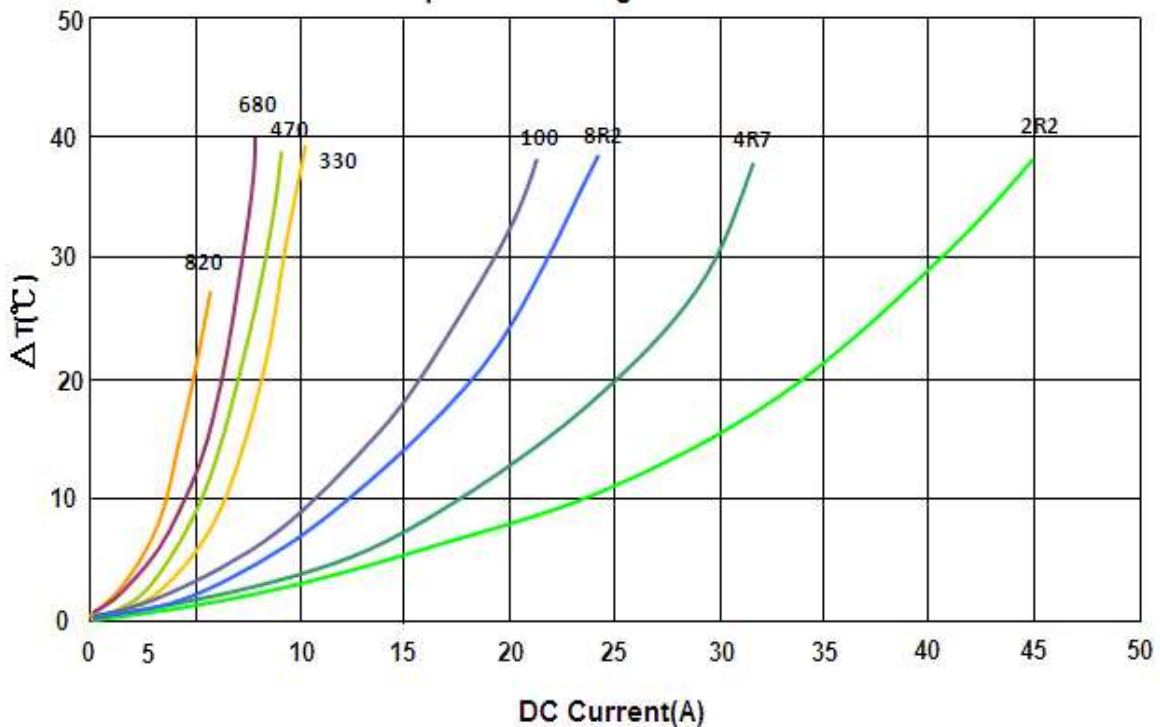

Please be sure to request approval specifications that provide further details of the products. Kindly note that the content of these specifications are subject to change or may be discontinued without prior notice. This product may not be designed/used in medical or high risk applications without Chilisin approval. Please contact our sales department before ordering.

AFDI00212010 Type

■ Dimensions

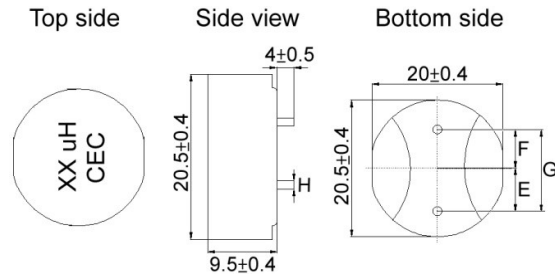

0.47uH~10uH

■ Recommended Land Pattern

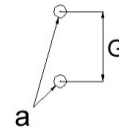

unit:mm

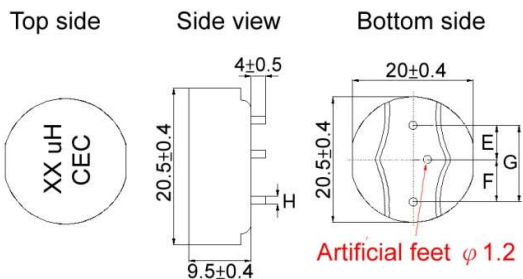

22uH~100uH

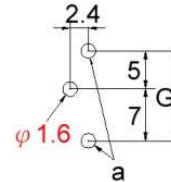

unit:mm

■ Electrical Characteristics

Part No.	L (uH)	Test Freq.	RDC(mΩ) Max(Typ)	Isat (A)Typ.	Irms (A)Typ.	Tol. (±%)	Marking	Dimensions				
								E	F	G	H	a
AFDI00212010R47M01	0.47	100kHz,1V	0.44(0.31)	65	65	20	0.47 uH	6±0.5	6±0.5	12±0.5	2.0±0.1	2.4
AFDI002120101R0M01	1.0	100kHz,1V	0.88(0.7)	60	62	20	1.0 uH	6±0.5	6±0.5	12±0.5	1.8±0.1	2.2
AFDI002120102R2M01	2.2	100kHz,1V	1.58(1.24)	40	46	20	2.2 uH	6±0.5	6±0.5	12±0.5	1.8±0.1	2.2
AFDI002120103R3M01	3.3	100kHz,1V	2.3(1.81)	34	35	20	3.3 uH	5.5±0.5	6.5±0.5	12±0.5	1.6±0.1	2
AFDI002120104R7M01	4.7	100kHz,1V	2.98(2.59)	30	27	20	4.7 uH	5±0.5	7±0.5	12±0.5	1.4±0.1	1.8
AFDI002120106R8M01	6.8	100kHz,1V	4.12(3.72)	28	25	20	6.8 uH	5±0.5	7±0.5	12±0.5	1.4±0.1	1.8
AFDI002120108R2M01	8.2	100kHz,1V	5.8(4.53)	26	21	20	8.2 uH	5±0.5	7±0.5	12±0.5	1.3±0.1	1.7
AFDI00212010100M01	10	100kHz,1V	7(5.57)	25	20	20	10 uH	5±0.5	7±0.5	12±0.5	1.3±0.1	1.7
AFDI00212010220M01	22	100kHz,1V	13.1(12.6)	16	13	20	22 uH	5±0.5	7±0.5	12±0.5	1.0±0.1	1.4
AFDI00212010330M01	33	100kHz,1V	22(18.9)	12	10	20	33 uH	5±0.5	7±0.5	12±0.5	0.9±0.1	1.3
AFDI00212010470M01	47	100kHz,1V	35.6(30.65)	10	8	20	47 uH	5±0.5	7±0.5	12±0.5	0.8±0.1	1.2
AFDI00212010680M01	68	100kHz,1V	44.8(38)	11	7	20	68 uH	5±0.5	7±0.5	12±0.5	0.8±0.1	1.2
AFDI00212010820M01	82	100kHz,1V	55.8(48.86)	9	6.4	20	82 uH	5±0.5	7±0.5	12±0.5	0.7±0.1	1.1
AFDI00212010101M01	100	100kHz,1V	62(54.51)	9	5.8	20	100 uH	5±0.5	7±0.5	12±0.5	0.7±0.1	1.1

Note: When ordering, please specify tolerance code. Tolerance: M=±20%

1. Customized Specifications are welcome
2. Operating temperature range -50°C~155°C(Including self - temperature rise)
3. Isat for Inductance drop 20% from its value without current
4. Irms for a 40°C temperature rise from 25°C ambient with current
5. Measure Equipment:

L: WK4237
RDC: CHEN HWA502
Isat: WK3260B/ 3265
Irms: WK3260B/ 3265

Please be sure to request approval specifications that provide further details of the products. Kindly note that the content of these specifications are subject to change or may be discontinued without prior notice. This product may not be designed/used in medical or high risk applications without Chilisin approval. Please contact our sales department before ordering.

AFDI00212010 Type

Characteristics Graph

Inductance vs. DC Current

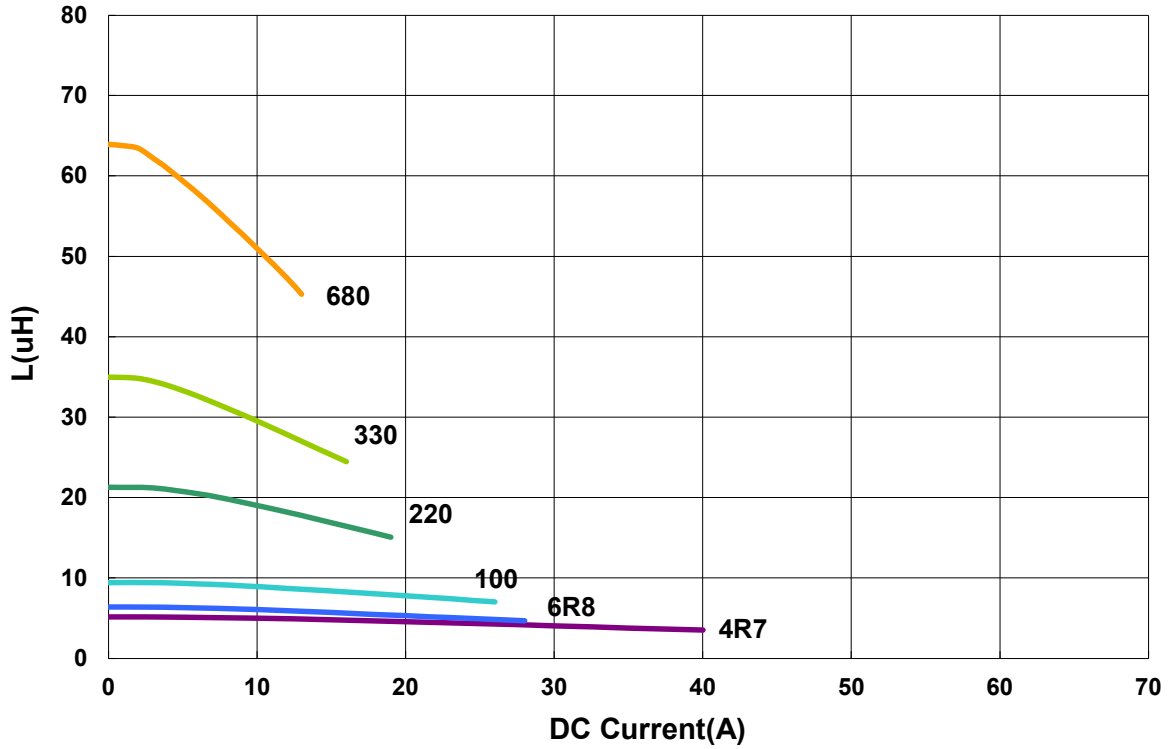

Temperature Change vs. DC Current

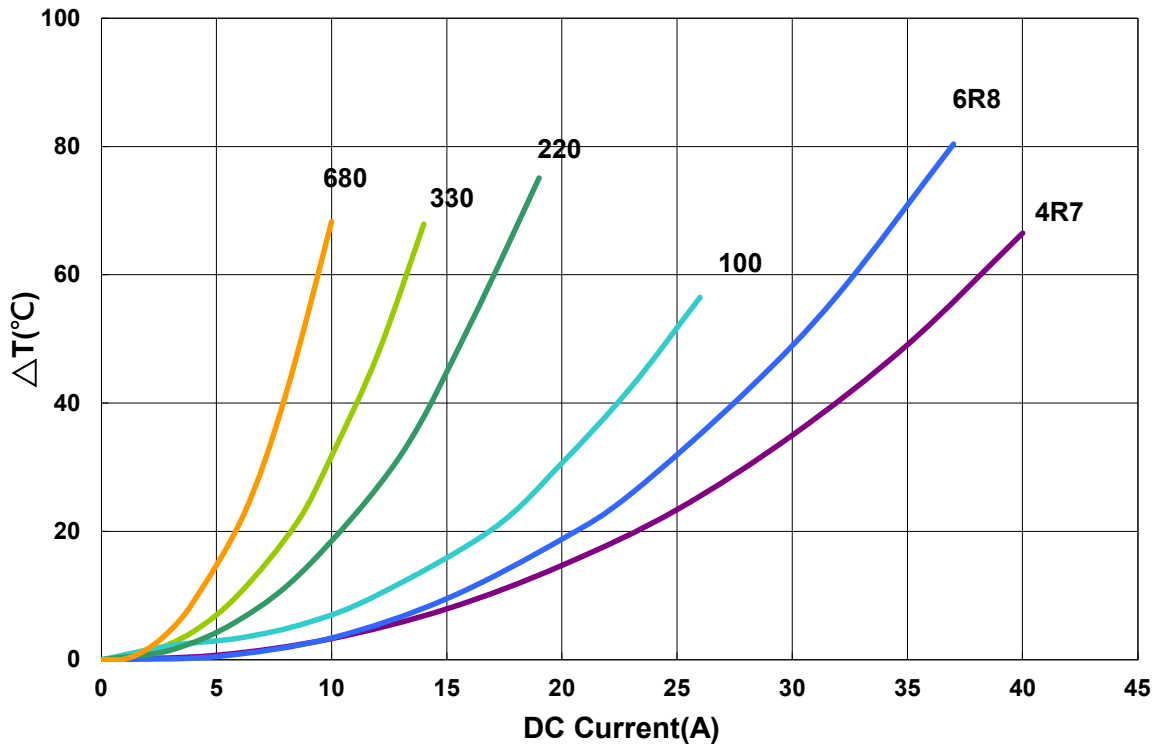

Please be sure to request approval specifications that provide further details of the products. Kindly note that the content of these specifications are subject to change or may be discontinued without prior notice. This product may not be designed/used in medical or high risk applications without Chilisin approval. Please contact our sales department before ordering.

AFDI00282811 Type

■ Dimensions

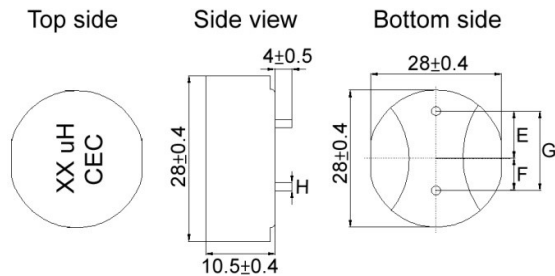

1.0uH~47uH

unit:mm

■ Recommended Land Pattern

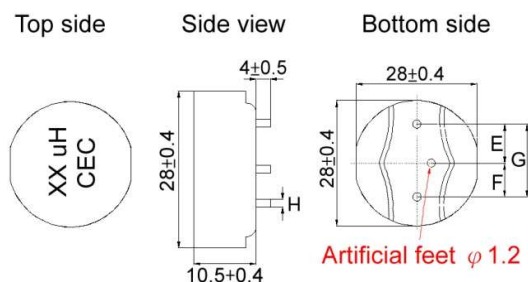
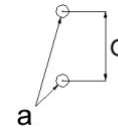

68uH~100uH

unit:mm

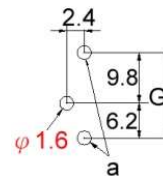

■ Electrical Characteristics

Part No.	L (uH)	Test Freq.	RDC(mΩ) Max(Typ)	Isat (A)Typ.	Irms (A)Typ.	Tol. (±%)	Marking	Dimensions				
								E	F	G	H	a
AFDI002828111R0M06	1.0	100kHz,1V	0.49(0.4)	70	90	20	1.0 uH	9.3±0.5	6.7±0.5	16±0.5	2.5±0.1	2.9
AFDI002828112R2M06	2.2	100kHz,1V	0.77(0.72)	64	72	20	2.2 uH	9.3±0.5	6.7±0.5	16±0.5	2.5±0.1	2.9
AFDI002828113R3M06	3.3	100kHz,1V	1.3(1.14)	60	57	20	3.3 uH	9.3±0.5	6.7±0.5	16±0.5	2.3±0.1	2.7
AFDI002828114R7M06	4.7	100kHz,1V	1.43(1.36)	52	53	20	4.7 uH	9.3±0.5	6.7±0.5	16±0.5	2.3±0.1	2.7
AFDI002828116R8M06	6.8	100kHz,1V	1.99(1.91)	44	45	20	6.8 uH	9.3±0.5	6.7±0.5	16±0.5	2.0±0.1	2.4
AFDI002828118R2M06	8.2	100kHz,1V	2.8(2.28)	32	40	20	8.2 uH	8±0.5	8±0.5	16±0.5	2.0±0.1	2.4
AFDI00282811100M06	10	100kHz,1V	3.64(3.13)	30	36	20	10 uH	8±0.5	8±0.5	16±0.5	1.8±0.1	2.2
AFDI00282811150M06	15	100kHz,1V	4.76(4.43)	20	28	20	15 uH	10±0.5	6±0.5	16±0.5	1.8±0.2	2.2
AFDI00282811220M06	22	100kHz,1V	6.85(6.47)	19	24	20	22 uH	9.8±0.5	6.2±0.5	16±0.5	1.6±0.1	2.0
AFDI00282811330M06	33	100kHz,1V	11.3(10.51)	18	18	20	33 uH	10±0.5	6±0.5	16±0.5	1.3±0.1	1.7
AFDI00282811470M06	47	100kHz,1V	14.7(13.69)	16.2	16	20	47 uH	10±0.5	6±0.5	16±0.5	1.3±0.1	1.7
AFDI00282811680M06	68	100kHz,1V	27.4(25.73)	11	11	20	68 uH	9.8±0.5	6.2±0.5	16±0.5	1.1±0.1	1.5
AFDI00282811820M06	82	100kHz,1V	30.5(29.3)	8	11	20	82 uH	9.8±0.5	6.2±0.5	16±0.5	1.1±0.1	1.5
AFDI00282811101M06	100	100kHz,1V	32.2(30.61)	7	11	20	100 uH	9.8±0.5	6.2±0.5	16±0.5	1.1±0.1	1.5

Note: When ordering, please specify tolerance code. Tolerance: M=±20%

1. Customized Specifications are welcome
2. Operating temperature range -50°C~155°C(Including self - temperature rise)
3. Isat for Inductance drop 20% from its value without current
4. Irms for a 40°C temperature rise from 25°C ambient with current
5. Measure Equipment:

L: WK4237
RDC: CHEN HWA502
Isat: WK3260B/ 3265
Irms: WK3260B/ 3265

Please be sure to request approval specifications that provide further details of the products. Kindly note that the content of these specifications are subject to change or may be discontinued without prior notice. This product may not be designed/used in medical or high risk applications without Chilisin approval. Please contact our sales department before ordering.

AFDI00282811 Type

Characteristics Graph

Inductance vs. DC Current

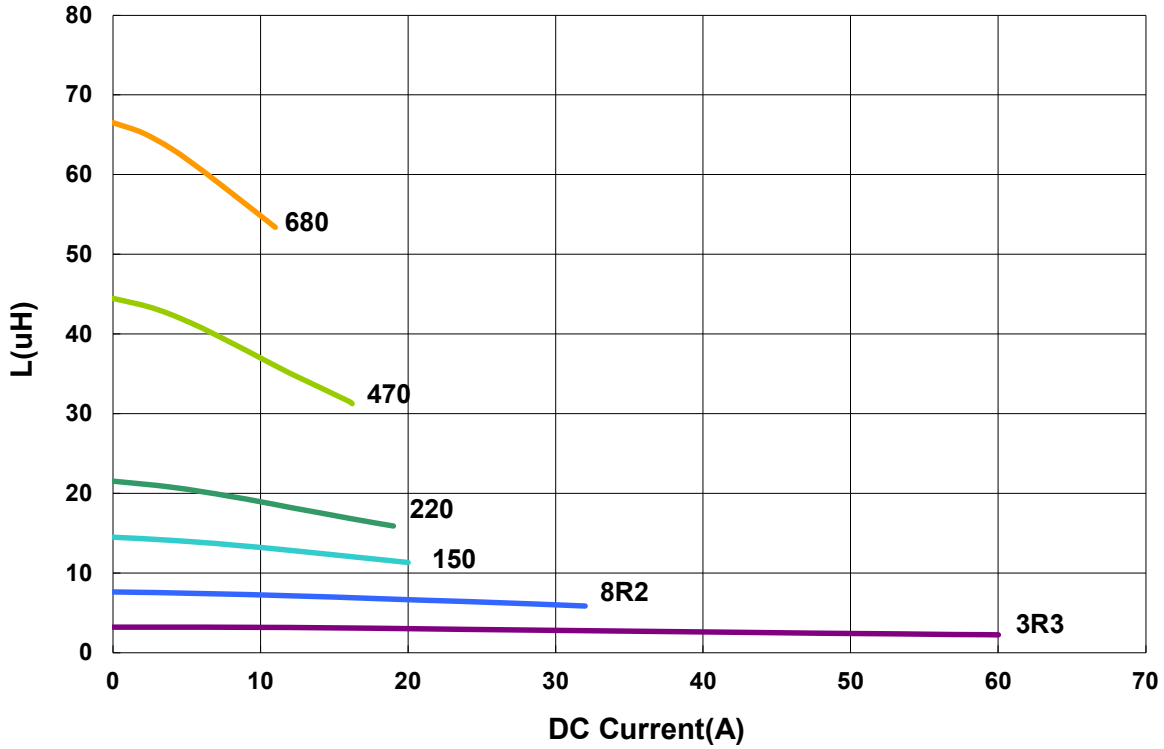

Temperature Change vs. DC Current

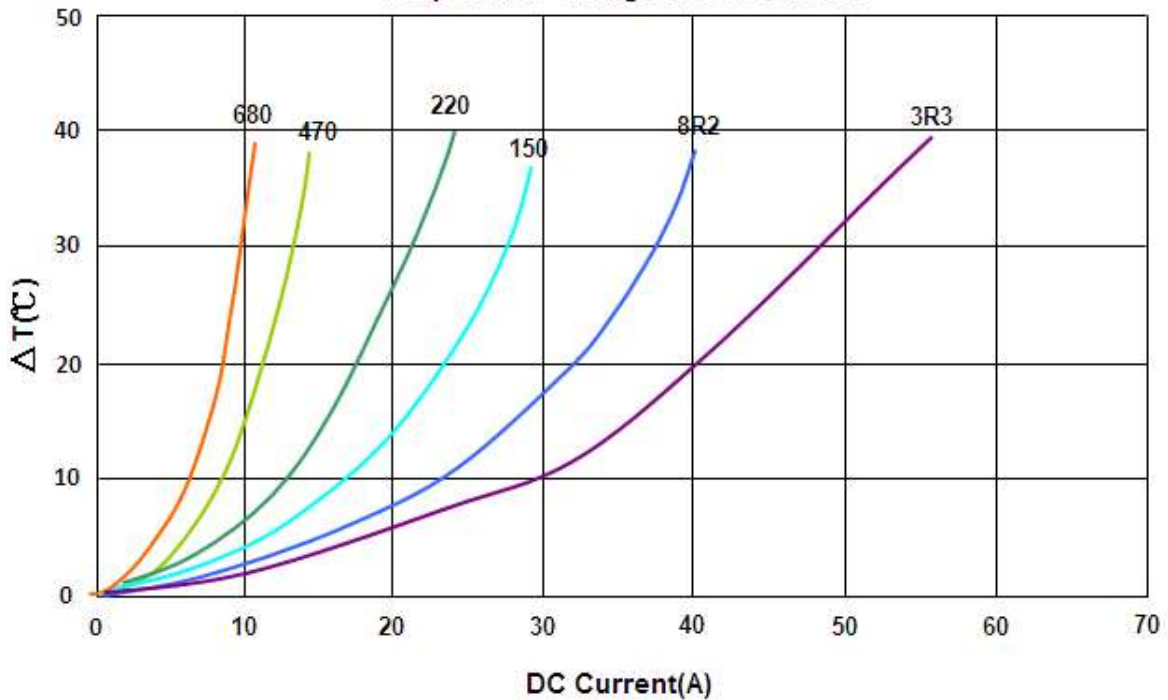

Please be sure to request approval specifications that provide further details of the products. Kindly note that the content of these specifications are subject to change or may be discontinued without prior notice. This product may not be designed/used in medical or high risk applications without Chilisin approval. Please contact our sales department before ordering.

AFDI00303012 Type

Dimensions

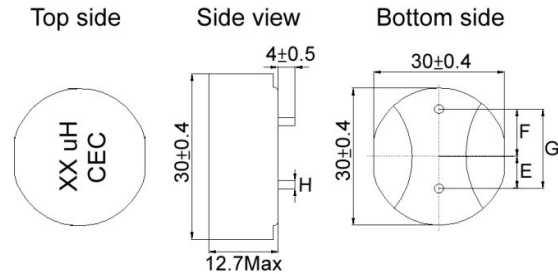

1.0uH~47uH

Recommended Land Pattern

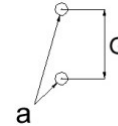

unit:mm

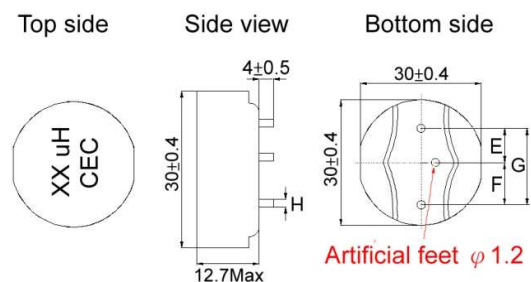

68uH~120uH

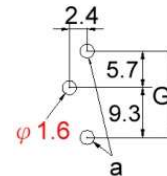

unit:mm

Electrical Characteristics

Part No.	L (uH)	Test Freq.	RDC(mΩ) Max(Typ)	Isat (A)Typ.	Irms (A)Typ.	Tol. (±%)	Marking	Dimensions				
								E	F	G	H	a
AFDI003030121R0M04	1.0	100kHz,1V	0.48(0.38)	65	90	20	1.0 uH	6.8±0.5	9.2±0.5	16±0.5	2.5±0.1	2.9
AFDI003030122R2M04	2.2	100kHz,1V	0.77(0.72)	65	72	20	2.2 uH	6.8±0.5	9.2±0.5	16±0.5	2.5±0.1	2.9
AFDI003030123R3M04	3.3	100kHz,1V	1.48(1.31)	62	60	20	3.3 uH	6.2±0.5	9.8±0.5	16±0.5	2.0±0.1	2.4
AFDI003030124R7M04	4.7	100kHz,1V	1.4(1.31)	53	54	20	4.7 uH	6.8±0.5	9.2±0.5	16±0.5	2.3±0.1	2.7
AFDI003030126R8M04	6.8	100kHz,1V	1.9(1.81)	44	45	20	6.8 uH	6.8±0.5	9.2±0.5	16±0.5	2.3±0.1	2.7
AFDI003030128R2M04	8.2	100kHz,1V	2.9(2.56)	34	37	20	8.2 uH	6.2±0.5	9.8±0.5	16±0.5	2.0±0.1	2.4
AFDI00303012100M04	10	100kHz,1V	3.6(3.2)	32	34	20	10 uH	6.2±0.5	9.8±0.5	16±0.5	1.8±0.1	2.2
AFDI00303012150M04	15	100kHz,1V	4.6(4.16)	28	28	20	15 uH	6.2±0.5	9.8±0.5	16±0.5	1.8±0.2	2.2
AFDI00303012220M04	22	100kHz,1V	6.83(6.43)	23	23	20	22 uH	5.75±0.5	9.25±0.5	15±0.5	1.6±0.1	2
AFDI00303012330M04	33	100kHz,1V	11.3(10.56)	18	18	20	33 uH	5.4±0.5	9.6±0.5	15±0.5	1.3±0.1	1.7
AFDI00303012470M04	47	100kHz,1V	14.6(13.45)	16.2	16	20	47 uH	5.4±0.5	9.6±0.5	15±0.5	1.3±0.1	1.7
AFDI00303012680M04	68	100kHz,1V	27(25.5)	11	12	20	68 uH	5.7±0.5	9.3±0.5	15±0.5	1.1±0.1	1.5
AFDI00303012101M04	100	100kHz,1V	32(29.71)	9	11	20	100 uH	5.7±0.5	9.3±0.5	15±0.5	1.1±0.1	1.5
AFDI00303012121M04	120	100kHz,1V	36(34.21)	8	9	20	120 uH	5.7±0.5	9.3±0.5	15±0.5	1.1±0.1	1.5

Note: When ordering, please specify tolerance code. Tolerance: M=±20%

1. Customized Specifications are welcome
2. Operating temperature range -50°C~155°C(Including self - temperature rise)
3. Isat for Inductance drop 20% from its value without current
4. Irms for a 40°C temperature rise from 25°C ambient with current
5. Measure Equipment:

L: WK4237
RDC: CHEN HWA502
Isat: WK3260B/ 3265
Irms: WK3260B/ 3265

Please be sure to request approval specifications that provide further details of the products. Kindly note that the content of these specifications are subject to change or may be discontinued without prior notice. This product may not be designed/used in medical or high risk applications without Chilisin approval. Please contact our sales department before ordering.

Leaded Power Chokes AFDI Series

**Automotive
AEC-Q200**

AFDI00303012 Type

■ Dimensions

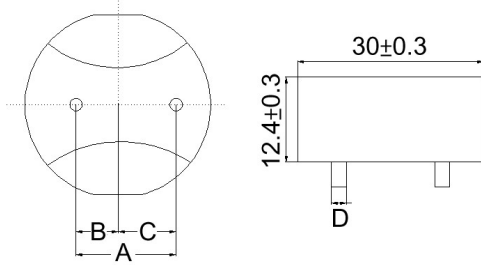

unit:mm

■ Recommended Land Pattern

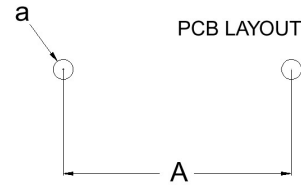

unit:mm

■ Electrical Characteristics

Part No.	Inductance (uH)	Test Freq.	RDC(mΩ) Typ(Max)	Isat (A)Typ.	Irms (A)Typ.	Tolerance (±%)	Marking	Dimensions				
								A	B	C	D	a
AFDI003030121R0M04	1.0	100kHz,1V	0.39(0.50)	65	90	20	1.0 uH	16±0.5	6.8±0.5	9.2±0.5	2.5±0.1	2.9

Please be sure to request approval specifications that provide further details of the products. Kindly note that the content of these specifications are subject to change or may be discontinued without prior notice. This product may not be designed/used in medical or high risk applications without Chilisin approval. Please contact our sales department before ordering.

AFDI00303012 Type

Characteristics Graph

Inductance vs. DC Current

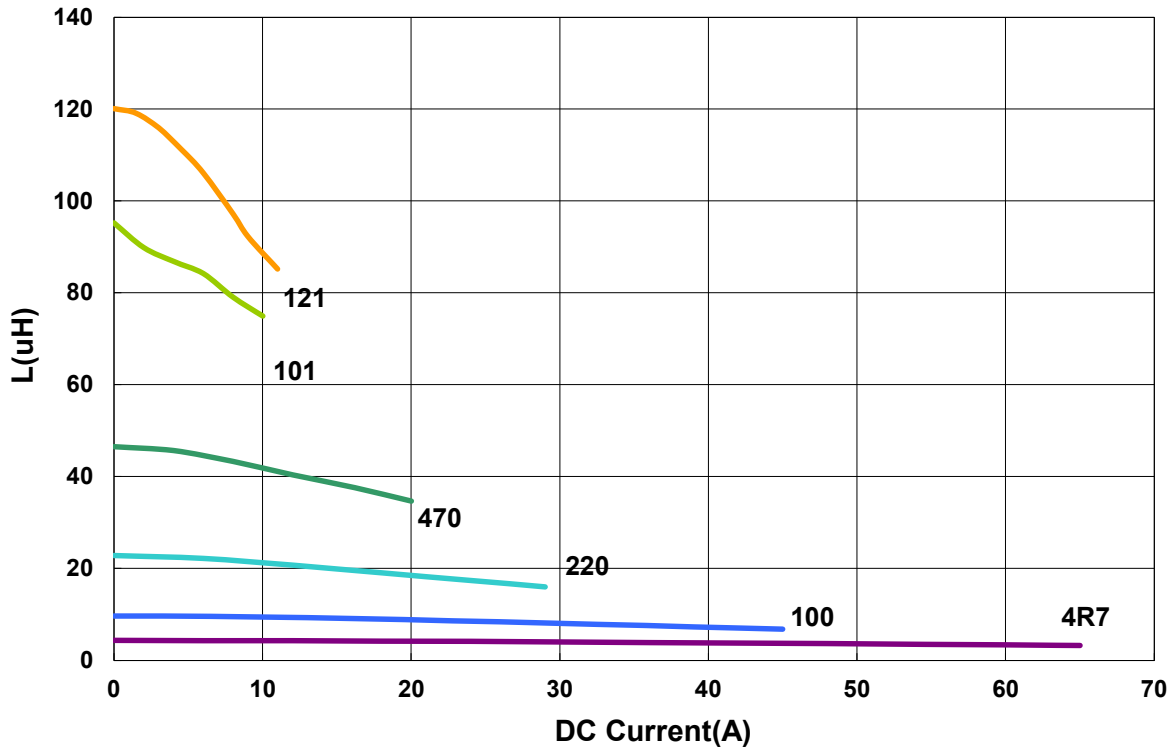

Temperature Change vs. DC Current

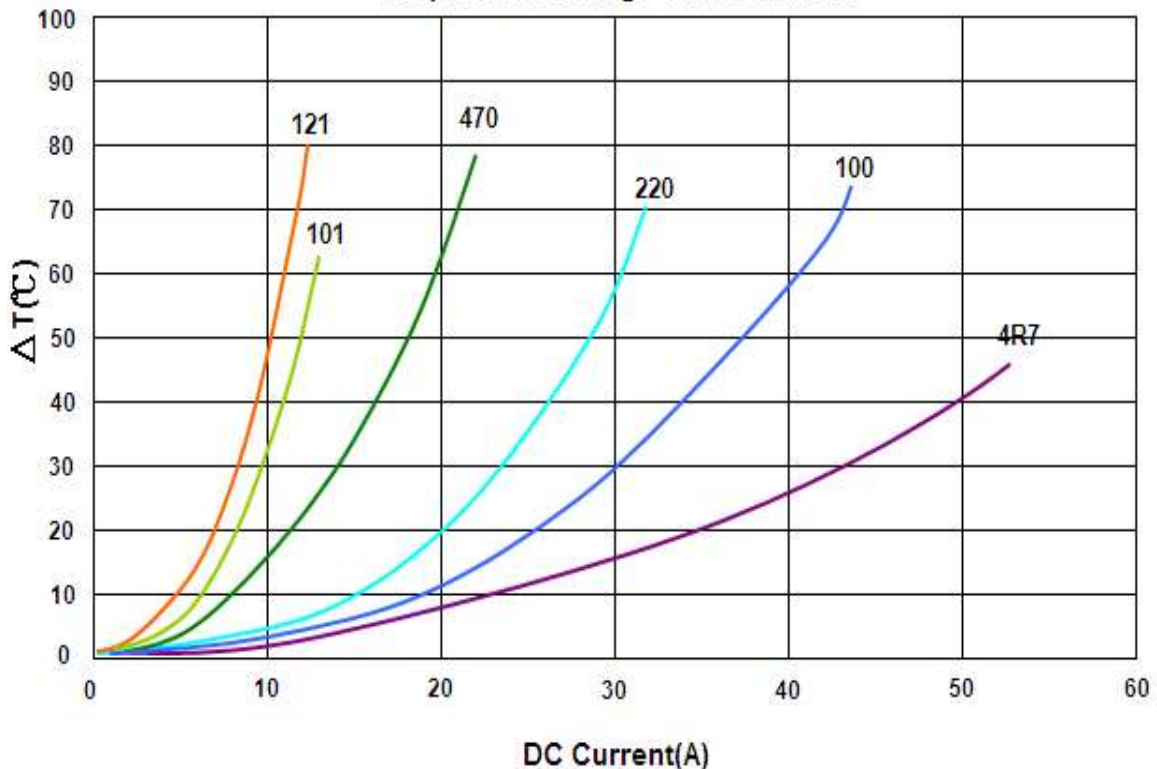

Please be sure to request approval specifications that provide further details of the products. Kindly note that the content of these specifications are subject to change or may be discontinued without prior notice. This product may not be designed/used in medical or high risk applications without Chilisin approval. Please contact our sales department before ordering.

■ Packaging

Plate Dimensions

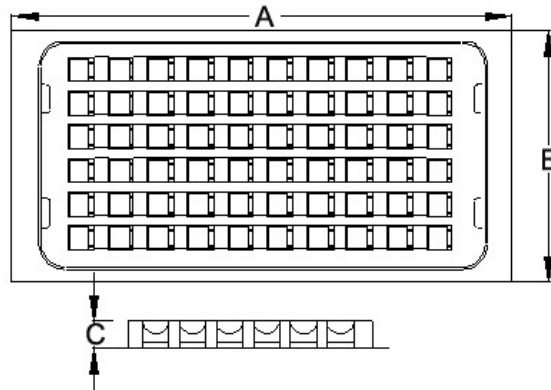

Packaging Quantity

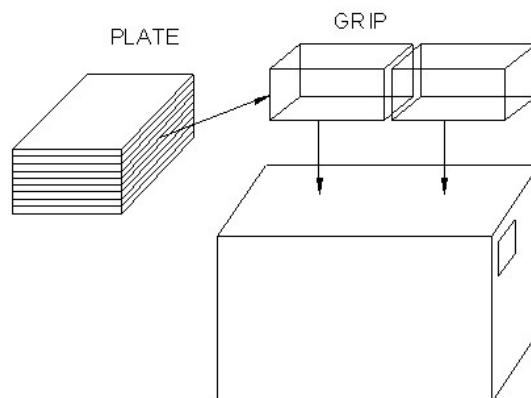

Dimensions in mm

TYPE	Plate Dimensions			Quantity				
	A	B	C	BULK	PLATE	PLATE/GRIP	GRIP	BOX
AFDI00111109	251	138	13	v	100	8	2	1600
AFDI00121210	251	138	13	v	100	8	2	1600
AFDI00131210	251	138	13	v	50	8	2	800
AFDI00161311	251	138	13	v	50	7	2	700
AFDI00191909	252	222	25.5	v	49	5	2	490
AFDI00212010	252	222	25.5	v	49	5	2	490
AFDI00282811	250	220	24	v	25	5	2	250
AFDI00303012	250	220	24	v	25	5	2	250

Please be sure to request approval specifications that provide further details of the products. Kindly note that the content of these specifications are subject to change or may be discontinued without prior notice. This product may not be designed/used in medical or high risk applications without Chilisin approval. Please contact our sales department before ordering.