

Data Sheet | Item Number: 2070-523/998-406

Through-Board SMD PCB Terminal Block; 0.75 mm²; Pin spacing 6.5 mm; 3-pole;
Push-in CAGE CLAMP®; in tape-and-reel packaging; white

<https://www.wago.com/2070-523/998-406>



Color: ■ white

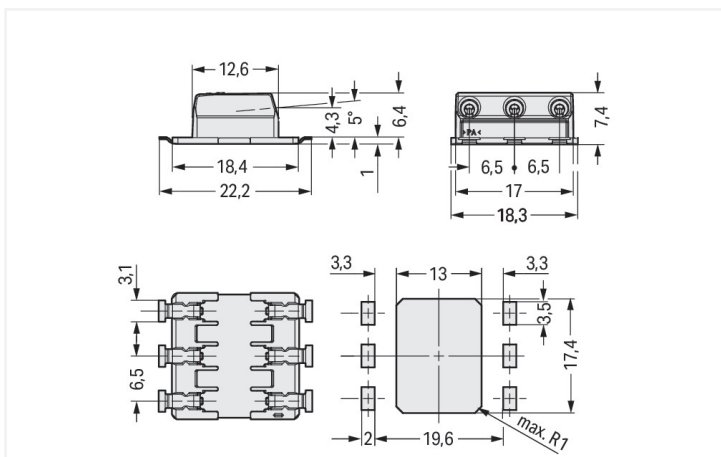

Dimensions in mm

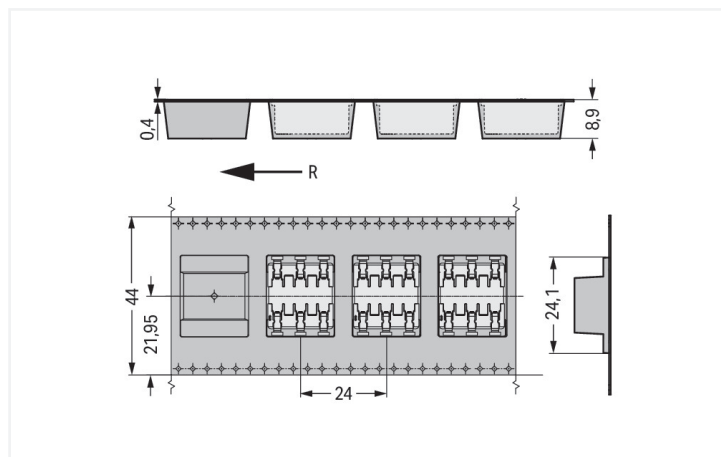

Dimensions in mm
R = feed direction

PCB terminal block, 2070 Series, with 6.5 mm pin spacing

This PCB terminal block (item number 2070-523/998-406) streamlines wire connections, making them both quick and easy. It is ideal for custom installations with different mounting types. Conductors can only be connected to this PCB terminal block if their strip length is between 8 and 10 mm. This product features one conductor terminal and utilizes Push-in CAGE CLAMP®. Our Push-in CAGE CLAMP® is a universal, maintenance-free connection solution for all conductor types, offering a key advantage: It allows direct insertion of both solid and fine-stranded conductors with ferrules without needing tools. No preparation is required; for example, crimping the conductor's ferrule is not necessary. The item's dimensions are (15.8 x 7.45 x 22.2) mm (width x height x depth). This PCB terminal block is suitable for conductor cross sections ranging from 0.2 mm² to 0.75 mm².

The contact surface is coated with tin. This PCB terminal block is operated with an operating tool. SMD is used to assemble the PCB terminal block. The conductor is designed to be inserted at a 0° angle..

Notes

Note	Depending on reflow soldering temperatures and times, color deviations may occur. These deviations will have no impact on functionality.
Variants:	Reel diameter of tape-and-reel packaging: 381 mm Other versions (or variants) can be requested from WAGO Sales or configured at https://configurator.wago.com/ .

Electrical data

Ratings	Electrical data for FR4 PCB type		
	IEC/EN 60664-1	IEC/EN 60664-1	IEC/EN 60664-1
Ratings per			
Overvoltage category	III	III	II
Pollution degree	3	2	2
Nominal voltage	320 V	320 V	630 V
Rated impulse withstand voltage	4 kV	4 kV	4 kV
Rated current	9 A	9 A	9 A

Ratings	Electrical data for metal-core PCBs		
	IEC/EN 60664-1	IEC/EN 60664-1	IEC/EN 60664-1
Ratings per			
Overvoltage category	III	III	II
Pollution degree	3	2	2
Nominal voltage	200 V	320 V	500 V
Rated impulse withstand voltage	4 kV	4 kV	4 kV
Rated current	9 A	9 A	9 A

Ratings

Approvals per	UL 1977
Rated voltage	600 V
Rated current	9 A

Connection Data

Clamping units	3
Total number of potentials	3
Number of connection types	1
Number of levels	1

Connection 1

Connection technology	Push-in CAGE CLAMP®
Actuation type	Operating tool
Solid conductor	0.2 ... 0.75 mm ² / 24 ... 18 AWG
Fine-stranded conductor	0.2 ... 0.75 mm ² / 24 ... 18 AWG
Strip length	8 ... 10 mm / 0.31 ... 0.39 inches
Conductor connection direction to PCB	0°
Pole number	3

Physical data

Pin spacing	6.5 mm / 0.256 inches
Width	15.8 mm / 0.622 inches
Height	7.45 mm / 0.293 inches
Depth	22.2 mm / 0.874 inches
Reel diameter of tape-and-reel packaging	330 mm
Tape width	44 mm
PCB thickness (max.)	2.4 mm

Mechanical data

Marking	+ - plain
Design	with cover
Mounting type	Through-board

PCB contact

PCB contact	SMD
Solder pin arrangement	over the entire terminal strip (in-line)
Number of solder pins per potential	2

Material data

Note (material data)	Information on material specifications can be found here
Color	white
Material group	I
Insulation material (main housing)	Polyphthalamide (PPA GF)
Flammability class per UL94	V0
Contact material	Copper alloy
Contact Plating	Tin
Fire load	0.019 MJ
Weight	2 g

Environmental requirements

Limit temperature range	-60 ... +105 °C
-------------------------	-----------------

Environmental Testing

Test specification: Railway applications – Rolling stock – Electronic equipment	DIN EN 50155 (VDE 0115-200):2022-06
Test procedure: Railway applications – Rolling stock equipment – Vibration and shock tests	DIN EN 61373 (VDE 0115-0106):2011-04
Spectrum/Mounting location	Service life test, Category 1, Class A/B
Functional test with noise-like oscillations	Test passed according to Section 8 of the standard
Frequency	$f_1 = 5 \text{ Hz}$ to $f_2 = 150 \text{ Hz}$
Acceleration	0.101g (highest test level used for all axes)
Test duration per axis	10 min.
Test directions	X, Y and Z axes
Monitoring of contact faults and interruptions	Passed
Voltage drop measurement before and after each axis	Passed
Simulated service life test through increased levels of noise-like oscillations	Test passed according to Section 9 of the standard
Frequency	$f_1 = 5 \text{ Hz}$ to $f_2 = 150 \text{ Hz}$
Acceleration	0.572g (highest test level used for all axes)
Test duration per axis	5 h
Test directions	X, Y and Z axes
Extended testing: Monitoring of contact faults and interruptions	Passed
Extended testing: Voltage drop measurement before and after each axis	Passed
Shock test	Test passed according to Section 10 of the standard
Shock pulse form	Half sine
Acceleration	5g (highest test level used for all axes)

Environmental Testing

Shock duration	30 ms
Number of shocks (per axis)	3 pos. und 3 neg.
Test directions	X, Y and Z axes
Extended testing: Monitoring of contact faults and interruptions	Passed
Extended testing: Voltage drop measurement before and after each axis	Passed
Vibration and shock stress for rolling stock equipment	Passed

Commercial data

PU (SPU)	1590 (318) pcs
Packaging type	Box
Country of origin	CH
GTIN	4055143652797
Customs tariff number	85369010000

Product Classification

UNSPSC	39121409
eCl@ss 10.0	27-14-11-06
eCl@ss 9.0	27-14-11-06
ETIM 9.0	EC001284
ETIM 10.0	EC001284
ECCN	NO US CLASSIFICATION

Environmental Product Compliance

RoHS Compliance Status	Compliant, No Exemption
------------------------	-------------------------

Approvals / Certificates

General approvals



Approval	Standard	Certificate Name
CB DEKRA Certification B.V.	IEC 60998	NL-57652
CB DEKRA Certification B.V.	EN 60998	NL-57653
KEMA/KEUR DEKRA Certification B.V.	EN 60998	71-107967
KEMA/KEUR DEKRA Certification B.V.	EN 60947-7-4	71-107965
UR Underwriters Laboratories Inc.	UL 1977	E45171

Declarations of conformity and manufacturer's declarations



Approval	Standard	Certificate Name
EU-Declaration of Conformity WAGO GmbH & Co. KG	-	-
Railway WAGO GmbH & Co. KG	-	Z00004398.000
UK-Declaration of Conformity WAGO GmbH & Co. KG	-	-

Downloads

Environmental Product Compliance

Compliance Search

Environmental Product Compliance
2070-523/998-406



Documentation

Additional Information

Technical Section

03.04.2019

pdf

2027.26 KB



CAD/CAE-Data

CAD data

2D/3D Models
2070-523/998-406



CAE data

ZUKEN Portal
2070-523/998-406



PCB Design

Symbol and Footprint
via SamacSys
2070-523/998-406



Symbol and Footprint
via Ultra Librarian
2070-523/998-406



1 Compatible Products

1.1 Optional Accessories

1.1.1 Tool

1.1.1.1 Operating tool



Item No.: 2070-400

Operating tool; made of insulating material; green

Installation Notes

Conductor termination

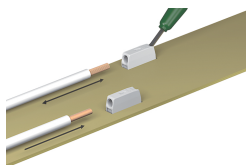

Insert fine-stranded conductors and remove all conductor types via operating tool. Solid conductors can also be terminated by simply pushing them in.

Conductor removal

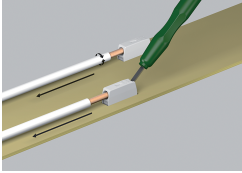

Use an operating tool or simply "twist and pull" to remove solid conductors.

Installation

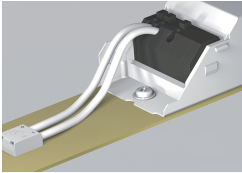

Shift wiring to the back of the LED module via 2070 Series SMD PCB Terminal Blocks.

Application

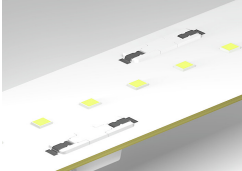

The variants with cover feature a center contact surface for easy pick-and-place assembly and minimum shadowing.

Application

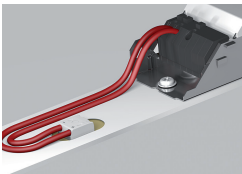

The printed variants offer unique pole marking on the back of the module.