

Parameter	Value
$V_{CEO}$	50V
$I_C$	4.0A

### ●Features

- 1) Suitable for Middle Power Driver
- 2) Complementary PNP Types : 2SAR543D
- 3) Low  $V_{CE(sat)}$   
 $V_{CE(sat)}=0.35V(\text{Max.})$   
 $(I_C/I_B=2A/100mA)$
- 4) Lead Free/RoHS Compliant.

### ●Inner circuit

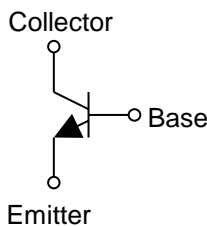

### ●Outline

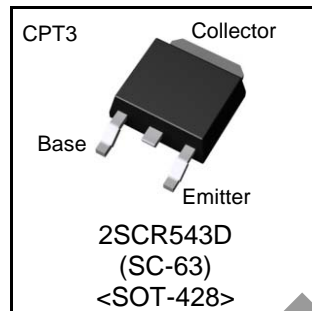

### ●Applications

Motor driver , LED driver  
Power supply

### ●Packaging specifications

Part No.	Package	Package size (mm)	Taping code	Reel size (mm)	Tape width (mm)	Basic ordering unit (pcs)	Marking
2SCR543D	CPT3	6595	TL	330	16	2,500	CR543

### ●Absolute maximum ratings (Ta = 25°C)

Parameter	Symbol	Values	Unit	
Collector-base voltage	$V_{CBO}$	50	V	
Collector-emitter voltage	$V_{CEO}$	50	V	
Emitter-base voltage	$V_{EBO}$	6	V	
Collector current	DC	$I_C$	4.0	A
	Pulsed	$I_{CP}^{*1}$	8.0	A
Power dissipation	$P_D^{*2}$	1	W	
	$P_D^{*3}$	10	W	
Junction temperature	$T_j$	150	°C	
Range of storage temperature	$T_{stg}$	-55 to +150	°C	

\*1 Pw=10ms , single pulse

\*2 Mounted on a substrate

\*3 Tc=25°C

●Electrical characteristics(Ta = 25°C)

Parameter	Symbol	Conditions	Min.	Typ.	Max.	Unit
Collector-emitter breakdown voltage	$BV_{CEO}$	$I_C = 1mA$	50	-	-	V
Collector-base breakdown voltage	$BV_{CBO}$	$I_C = 100\mu A$	50	-	-	V
Emitter-base breakdown voltage	$BV_{EBO}$	$I_E = 100\mu A$	6	-	-	V
Collector cut-off current	$I_{CBO}$	$V_{CB} = 50V$	-	-	1	$\mu A$
Emitter cut-off current	$I_{EBO}$	$V_{EB} = 4V$	-	-	1	$\mu A$
Collector-emitter saturation voltage	$V_{CE(sat)}^{*1}$	$I_C = 2A, I_B = 100mA$	-	0.13	0.35	V
DC current gain	$h_{FE}$	$V_{CE} = 3V, I_C = 100mA$	180	-	450	-
Transition frequency	$f_T$	$V_{CE} = 10V, I_E = -500mA$ $f = 100MHz$	-	300	-	MHz
Output capacitance	$C_{ob}$	$V_{CB} = 10V, I_E = 0A,$ $f = 1MHz$	-	20	-	pF
Turn-on time	$t_{on}^{*2}$	$I_C = 2A$ $I_{B1} = 200mA$ $I_{B2} = -200mA$ $V_{CC} \approx 10V$	-	50	-	ns
Storage time	$t_{stg}^{*2}$		-	450	-	ns
Fall time	$t_f^{*2}$		-	85	-	ns

\*1 Pulsed

\*2 See switching time test circuit

●Switching time test circuit

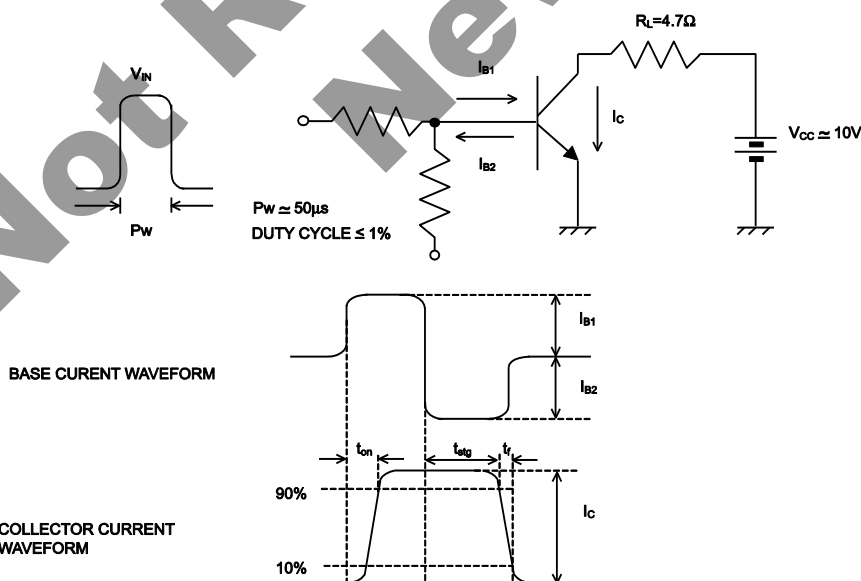

●Electrical characteristic curves(Ta = 25°C)

Fig.1 Ground Emitter Propagation Characteristics

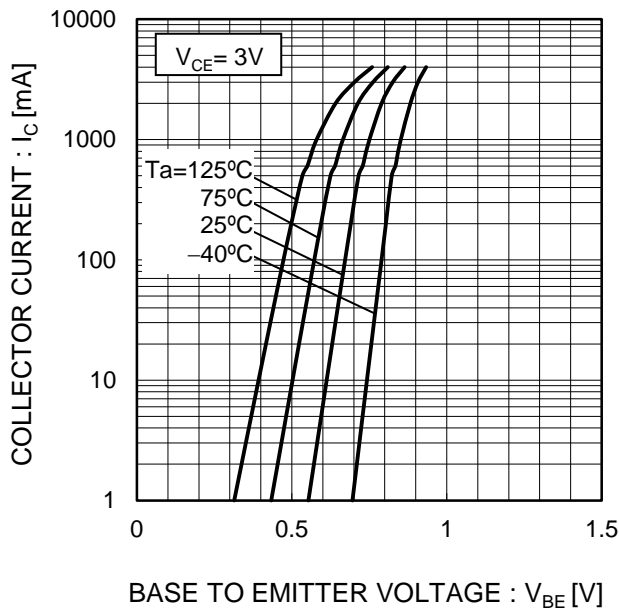

Fig.2 Typical Output Characteristics

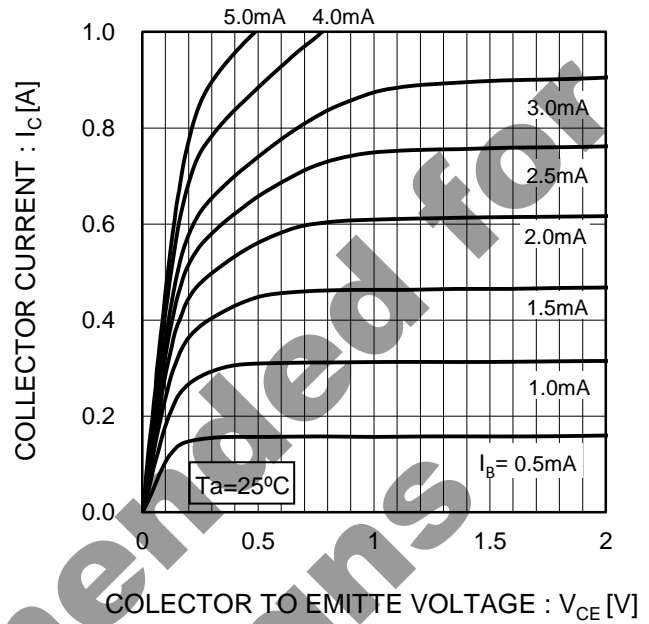

Fig.3 DC Current Gain vs. Collector Current(I)

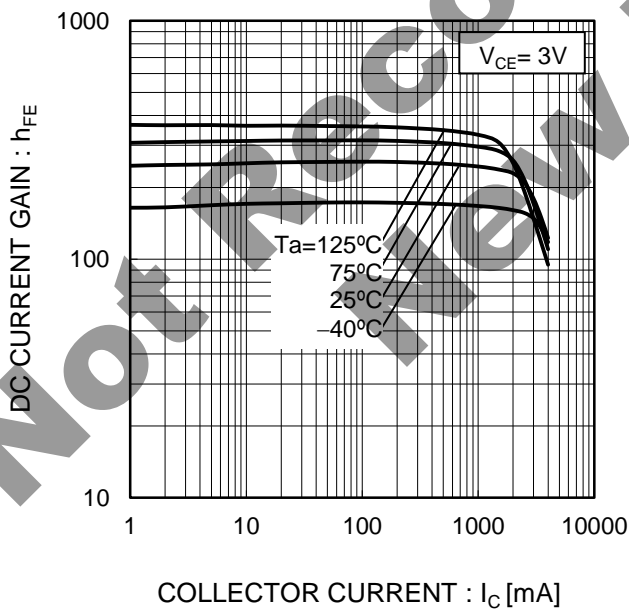
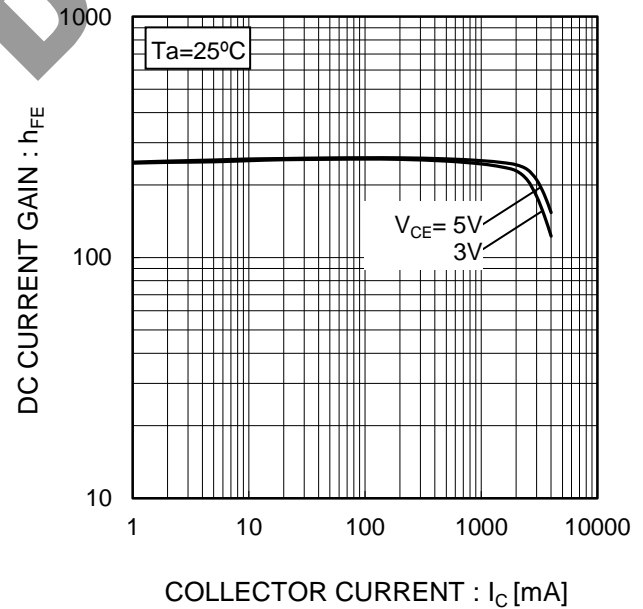

Fig.4 DC current gain vs. output current (II)



●Electrical characteristic curves(Ta = 25°C)

Fig.5 Collector-Emitter Saturation Voltage vs. Collector Current (I)

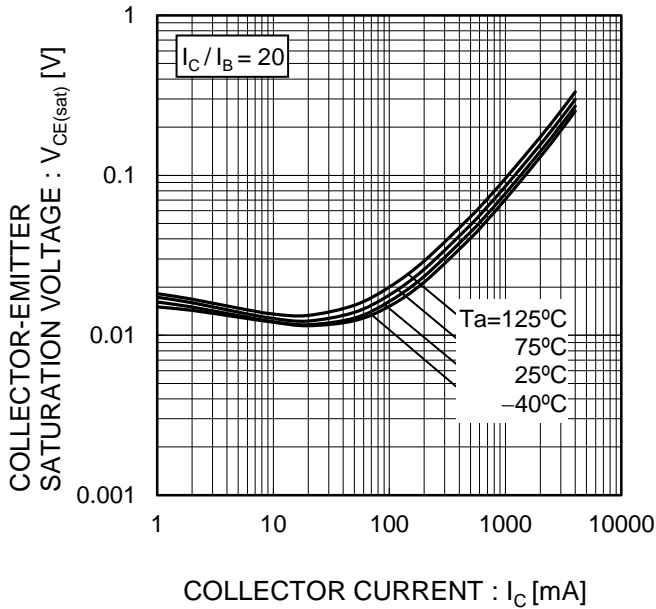

Fig.6 Collector-Emitter Saturation Voltage vs. Collector Current (II)

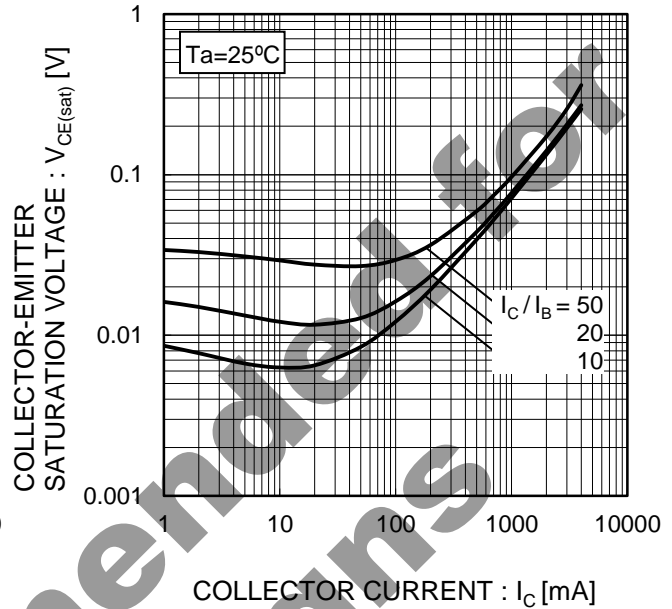

Fig.7 Base-Emitter Saturation Voltage vs. Collector Current

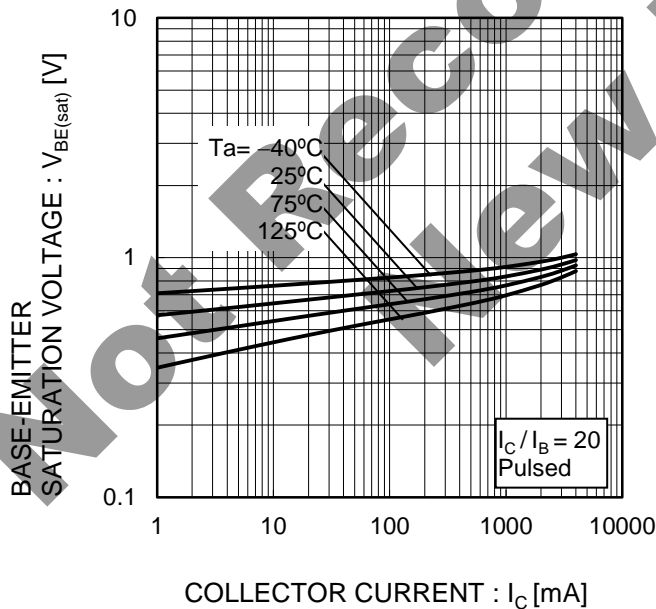
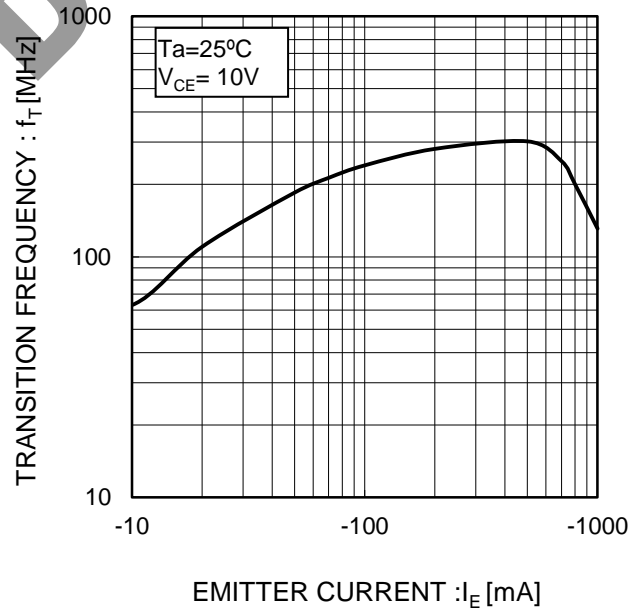

Fig.8 Gain Bandwidth Product vs. Emitter Current



●Electrical characteristic curves(Ta = 25°C)

Fig.9 Emitter input capacitance vs. Emitter-Base Voltage  
Collector output capacitance vs. Collector-Base Voltage

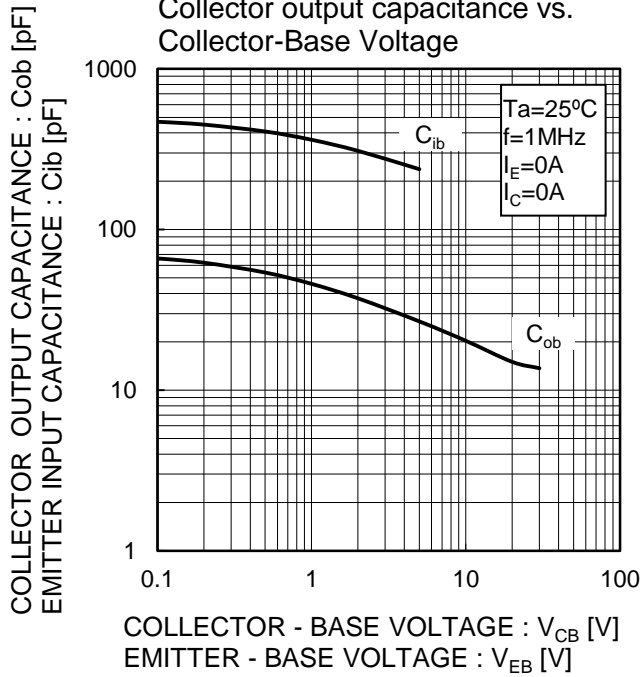
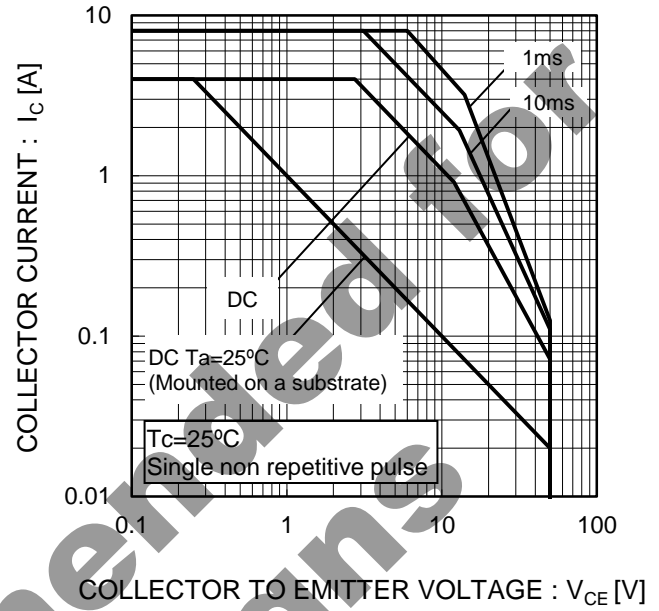

Fig.10 Safe Operating Area



Not Recommended for New Design

●Dimensions (Unit : mm)

CPT3

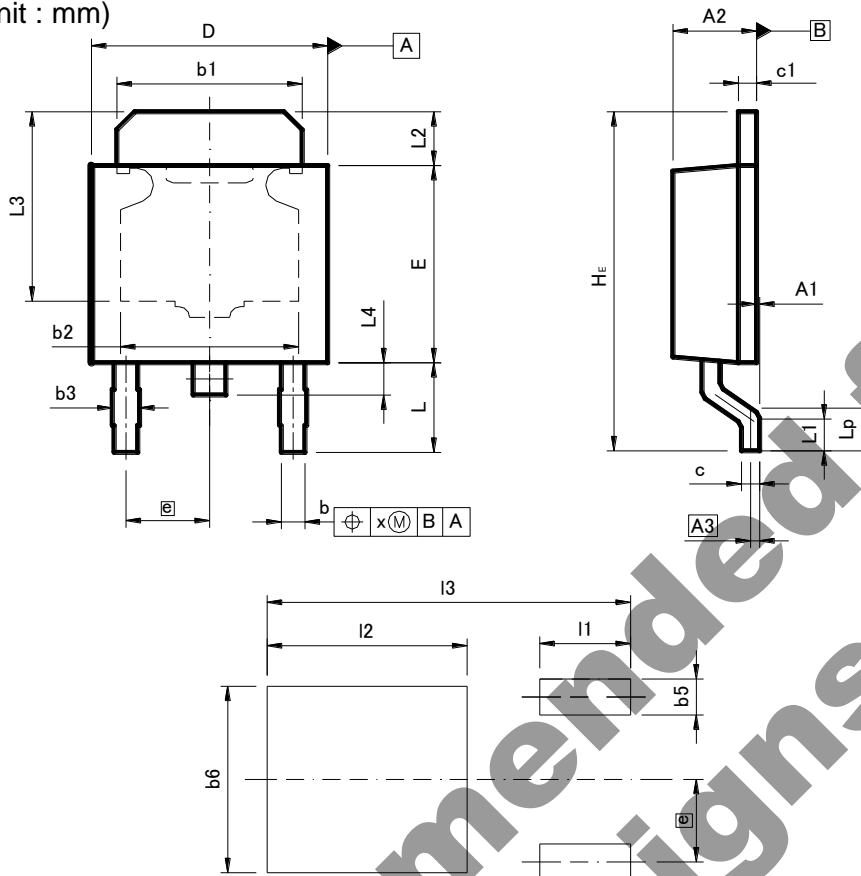

Pattern of terminal position areas  
 [Not a recommended pattern of soldering pads]

DIM	MILIMETERS		INCHES	
	MIN	MAX	MIN	MAX
A1	0.00	0.15	0.000	0.006
A2	2.20	2.50	0.087	0.098
A3	0.25		0.010	
b	0.55	0.75	0.022	0.030
b1	5.00	5.30	0.197	0.209
b2	5.00		0.197	
b3	0.75		0.030	
c	0.40	0.60	0.016	0.024
c1	0.40	0.60	0.016	0.024
D	6.30	6.70	0.248	0.264
E	5.40	5.80	0.213	0.228
e	2.30		0.091	
HE	9.00	10.00	0.354	0.394
L	2.20	2.80	0.087	0.110
L1	0.80	1.40	0.031	0.055
L2	1.20	1.80	0.047	0.071
L3	5.30		0.209	
L4	0.90		0.035	
Lp	1.00	1.60	0.039	0.063
x	-	0.25	-	0.010

DIM	MILIMETERS		INCHES	
	MIN	MAX	MIN	MAX
b5	-	1.00	-	0.04
b6	-	5.20	-	0.205
I1	-	2.50	-	0.098
I2	-	5.50	-	0.217
I3	-	10.00	-	0.394

Dimension in mm / inches

## Notes

- 1) The information contained herein is subject to change without notice.
- 2) Before you use our Products, please contact our sales representative and verify the latest specifications :
- 3) Although ROHM is continuously working to improve product reliability and quality, semiconductors can break down and malfunction due to various factors. Therefore, in order to prevent personal injury or fire arising from failure, please take safety measures such as complying with the derating characteristics, implementing redundant and fire prevention designs, and utilizing backups and fail-safe procedures. ROHM shall have no responsibility for any damages arising out of the use of our Products beyond the rating specified by ROHM.
- 4) Examples of application circuits, circuit constants and any other information contained herein are provided only to illustrate the standard usage and operations of the Products. The peripheral conditions must be taken into account when designing circuits for mass production.
- 5) The technical information specified herein is intended only to show the typical functions of and examples of application circuits for the Products. ROHM does not grant you, explicitly or implicitly, any license to use or exercise intellectual property or other rights held by ROHM or any other parties. ROHM shall have no responsibility whatsoever for any dispute arising out of the use of such technical information.
- 6) The Products are intended for use in general electronic equipment (i.e. AV/OA devices, communication, consumer systems, gaming/entertainment sets) as well as the applications indicated in this document.
- 7) The Products specified in this document are not designed to be radiation tolerant.
- 8) For use of our Products in applications requiring a high degree of reliability (as exemplified below), please contact and consult with a ROHM representative : transportation equipment (i.e. cars, ships, trains), primary communication equipment, traffic lights, fire/crime prevention, safety equipment, medical systems, servers, solar cells, and power transmission systems.
- 9) Do not use our Products in applications requiring extremely high reliability, such as aerospace equipment, nuclear power control systems, and submarine repeaters.
- 10) ROHM shall have no responsibility for any damages or injury arising from non-compliance with the recommended usage conditions and specifications contained herein.
- 11) ROHM has used reasonable care to ensure the accuracy of the information contained in this document. However, ROHM does not warrant that such information is error-free, and ROHM shall have no responsibility for any damages arising from any inaccuracy or misprint of such information.
- 12) Please use the Products in accordance with any applicable environmental laws and regulations, such as the RoHS Directive. For more details, including RoHS compatibility, please contact a ROHM sales office. ROHM shall have no responsibility for any damages or losses resulting from non-compliance with any applicable laws or regulations.
- 13) When providing our Products and technologies contained in this document to other countries, you must abide by the procedures and provisions stipulated in all applicable export laws and regulations, including without limitation the US Export Administration Regulations and the Foreign Exchange and Foreign Trade Act.
- 14) This document, in part or in whole, may not be reprinted or reproduced without prior consent of ROHM.



Thank you for your accessing to ROHM product informations.  
More detail product informations and catalogs are available, please contact us.

## ROHM Customer Support System

<http://www.rohm.com/contact/>