

## Data Sheet | Item Number: 831-3108/037-000

1-conductor female connector; Push-in CAGE CLAMP®; 10 mm²; Pin spacing 7.62 mm; 8-pole; 100% protected against mismatching; Lateral locking levers; 10,00 mm²; light gray

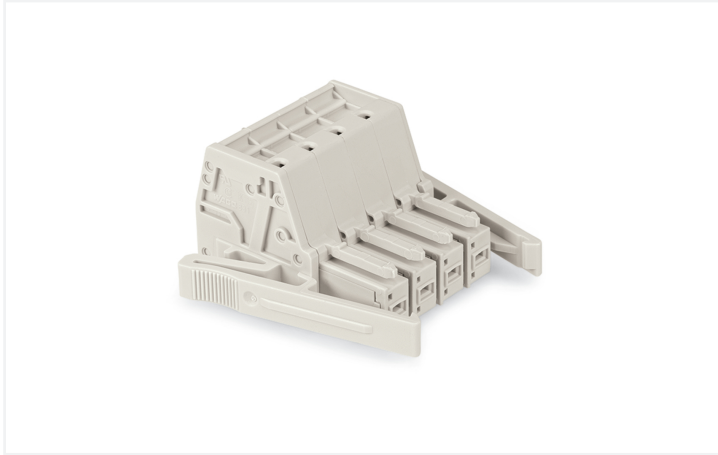

<https://www.wago.com/831-3108/037-000>



Color: ■ light gray

Similar to illustration

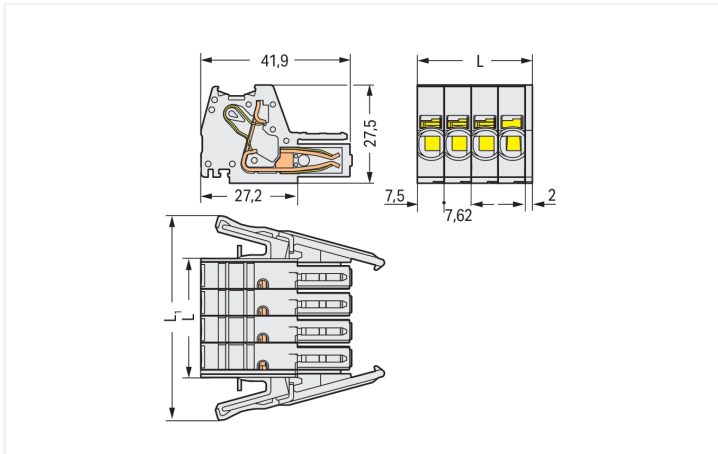
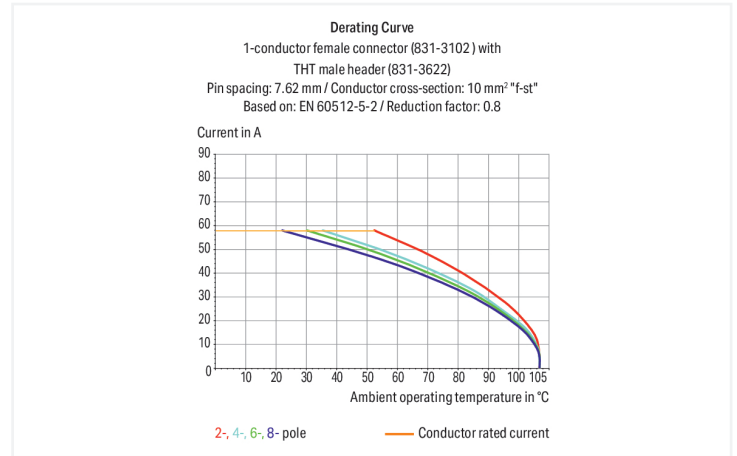

Dimensions in mm

$L = (\text{pole no.} - 1) \times \text{pin spacing} + 10.5 \text{ mm}$   
 $L_1 = L + 23.7 \text{ mm}$

### Female connector, 831 Series, Push-in CAGE CLAMP®

This female connector (item number 831-3108/037-000) is designed for fault-free electrical installations. Conductors should only be connected to this female connector if their strip length is between 13 and 15 mm. This product features one conductor terminal and utilizes Push-in CAGE CLAMP®. Our Push-in CAGE CLAMP® is a universal, maintenance-free connection solution for all conductor types, offering a key advantage: both solid and fine-stranded conductors with ferrules can be directly inserted without the need for tools or any preparation, such as crimping the ferrule. The item's dimensions are (87.64 x 27.6 x 41.9) mm (width x height x depth). This female connector is suitable for conductor cross sections ranging from 0.5 mm² to 10 mm².

Tin is used for coating the contact surfaces.

## Notes

## Safety Information

The MCS – MULTI CONNECTION SYSTEM includes connectors without breaking capacity in accordance with DIN EN 61984. When used as intended, these connectors must not be connected/disconnected when live or under load. When used as intended, these connectors must not be connected/disconnected when live or under load. The circuit design should ensure header pins, which can be touched, are not live when unmated.

## Variants:

Other pole numbers

Other versions (or variants) can be requested from WAGO Sales or configured at <https://configurator.wago.com/>.

## Electrical data

Ratings per	IEC/EN 60664-1		
Overvoltage category	III	III	II
Pollution degree	3	2	2
Nominal voltage	800 V	1000 V	1000 V
Rated impulse withstand voltage	8 kV	8 kV	8 kV
Rated current	41 A	41 A	41 A

Approvals per	UL 1059		
Use group	B	C	D
Rated voltage	-	600 V	-
Rated current	-	42 A	-

Approvals per	CSA		
Use group	B	C	D
Rated voltage	-	600 V	-
Rated current	-	41 A	-

## Connection Data

Clamping units	8
Total number of potentials	8
Number of connection types	1
Number of levels	1

## Connection 1

Connection technology	Push-in CAGE CLAMP®
Actuation type	Operating tool
Actuation direction 1	Operation parallel to conductor entry
Solid conductor	0.5 ... 10 mm <sup>2</sup> / 20 ... 8 AWG
Fine-stranded conductor	0.5 ... 10 mm <sup>2</sup> / 20 ... 8 AWG
Fine-stranded conductor; with insulated ferrule	0.5 ... 6 mm <sup>2</sup>
Fine-stranded conductor; with uninsulated ferrule	0.5 ... 6 mm <sup>2</sup>
Strip length	13 ... 15 mm / 0.51 ... 0.59 inches
Pole number	8
Conductor entry direction to mating direction	0°

## Physical data

Pin spacing	7.62 mm / 0.3 inches
Width	87.64 mm / 3.45 inches
Height	27.6 mm / 1.087 inches
Depth	41.9 mm / 1.65 inches

### Mechanical data

Variable coding	Yes
Anti-rotation protection	Yes

### Plug-in connection

Contact type (pluggable connector)	Female connector/socket
Connector (connection type)	for conductor
Mismating protection	Yes
Locking of plug-in connection	Locking lever

### Material data

Note (material data)	<a href="#">Information on material specifications can be found here</a>
Color	light gray
Material group	I
Insulation material (main housing)	Polyamide (PA66)
Flammability class per UL94	V0
Clamping spring material	Chrome-nickel spring steel (CrNi)
Material of the additional spring for socket contact	Chrome-nickel spring steel (CrNi)
Contact material	Electrolytic copper (E <sub>Cu</sub> )
Contact Plating	Tin
Fire load	0.81 MJ
Weight	62.5 g

### Environmental requirements

Limit temperature range	-60 ... +105 °C
Processing temperature	-35 ... +60 °C

### Commercial data

Product Group	3 (Multi Conn. System)
PU (SPU)	12 pcs
Packaging type	Box
Country of origin	PL
GTIN	4066966854664
Customs tariff number	85366990990

### Product Classification

UNSPSC	39121409
eCl@ss 10.0	27-14-11-06
eCl@ss 9.0	27-14-11-06
ETIM 9.0	EC001284
ETIM 10.0	EC001284
ECCN	NO US CLASSIFICATION

**Environmental Product Compliance**

RoHS Compliance Status Compliant, No Exemption

**Approvals / Certificates**

**General approvals**



Approval	Standard	Certificate Name
CB DEKRA Certification B.V.	IEC 61984	NL-61360/M1
CSA DEKRA Certification B.V.	C22.2	1466354
KEMA/KEUR DEKRA Certification B.V.	EN 61984	71-116057
UR Underwriters Laboratories Inc.	UL 1059	UL-US-2426356-0

**Downloads**

**Environmental Product Compliance**

Compliance Search
Environmental Product Compliance 831-3108/037-000 <span style="float: right;">↓</span>

**Documentation**

Additional Information			
Technical Section	03.04.2019	pdf 2027.26 KB	↓

**CAD/CAE-Data**

CAD data
2D/3D Models 831-3108/037-000 <span style="float: right;">↓</span>

CAE data
EPLAN Data Portal 831-3108/037-000 <span style="float: right;">↓</span>
ZUKEN Portal 831-3108/037-000 <span style="float: right;">↓</span>

## 1 Compatible Products

### 1.1 System counterpart

#### 1.1.1 Male connector/plug



**Item No.: 831-3208**

1-conductor male connector; Push-in CA-GE CLAMP®; 10 mm²; Pin spacing 7.62 mm; 8-pole; 100% protected against mis-mating; 10,00 mm²; light gray

**Item No.: 831-3628**

THT male header; 1.0 x 1.2 mm solder pin; angled; 100% protected against mis-mating; Pin spacing 7.62 mm; 8-pole; light gray

**Item No.: 831-3648**

THT male header; 1.0 x 1.2 mm solder pin; angled; 100% protected against mis-mating; Pin spacing 7.62 mm; 8-pole; light gray

**Item No.: 831-3608**

THT male header; 1.0 x 1.2 mm solder pin; straight; 100% protected against mis-mating; Pin spacing 7.62 mm; 8-pole; light gray

## 1.2 Optional Accessories

### 1.2.1 Marking

#### 1.2.1.1 Marker



**Item No.: 2009-145/000-006**

Mini-WSB Inline; for Smart Printer; 1700 pieces on roll; stretchable 5 - 5.2 mm; plain; snap-on type; blue

**Item No.: 2009-145/000-007**

Mini-WSB Inline; for Smart Printer; 1700 pieces on roll; stretchable 5 - 5.2 mm; plain; snap-on type; gray

**Item No.: 2009-145/000-023**

Mini-WSB Inline; for Smart Printer; 1700 pieces on roll; stretchable 5 - 5.2 mm; plain; snap-on type; green

**Item No.: 2009-145/000-012**

Mini-WSB Inline; for Smart Printer; 1700 pieces on roll; stretchable 5 - 5.2 mm; plain; snap-on type; orange



**Item No.: 2009-145/000-005**

Mini-WSB Inline; for Smart Printer; 1700 pieces on roll; stretchable 5 - 5.2 mm; plain; snap-on type; red

**Item No.: 2009-145/000-024**

Mini-WSB Inline; for Smart Printer; 1700 pieces on roll; stretchable 5 - 5.2 mm; plain; snap-on type; violet

**Item No.: 2009-145**

Mini-WSB Inline; for Smart Printer; 1700 pieces on roll; stretchable 5 - 5.2 mm; plain; snap-on type; white

**Item No.: 2009-145/000-002**

Mini-WSB Inline; for Smart Printer; 1700 pieces on roll; stretchable 5 - 5.2 mm; plain; snap-on type; yellow



**Item No.: 248-501/000-006**

Mini-WSB marking card; as card; not stretchable; plain; snap-on type; blue

**Item No.: 248-501/000-007**

Mini-WSB marking card; as card; not stretchable; plain; snap-on type; gray

**Item No.: 248-501/000-023**

Mini-WSB marking card; as card; not stretchable; plain; snap-on type; green

**Item No.: 248-501/000-017**

Mini-WSB marking card; as card; not stretchable; plain; snap-on type; light green



**Item No.: 248-501/000-012**

Mini-WSB marking card; as card; not stretchable; plain; snap-on type; orange

**Item No.: 248-501/000-005**

Mini-WSB marking card; as card; not stretchable; plain; snap-on type; red

**Item No.: 248-501**

Mini-WSB marking card; as card; not stretchable; plain; snap-on type; white

**Item No.: 248-501/000-002**

Mini-WSB marking card; as card; not stretchable; plain; snap-on type; yellow



**Item No.: 793-5501/000-006**

WMB marking card; as card; for terminal block width 5 - 17.5 mm; stretchable 5 - 5.2 mm; plain; snap-on type; blue

**Item No.: 793-5501/000-007**

WMB marking card; as card; for terminal block width 5 - 17.5 mm; stretchable 5 - 5.2 mm; plain; snap-on type; gray

**Item No.: 793-5501/000-023**

WMB marking card; as card; for terminal block width 5 - 17.5 mm; stretchable 5 - 5.2 mm; plain; snap-on type; green

**Item No.: 793-5501/000-017**

WMB marking card; as card; for terminal block width 5 - 17.5 mm; stretchable 5 - 5.2 mm; plain; snap-on type; light green



**Item No.: 793-5501/000-012**

WMB marking card; as card; for terminal block width 5 - 17.5 mm; stretchable 5 - 5.2 mm; plain; snap-on type; orange

**Item No.: 793-5501/000-005**

WMB marking card; as card; for terminal block width 5 - 17.5 mm; stretchable 5 - 5.2 mm; plain; snap-on type; red

**Item No.: 793-5501/000-024**

WMB marking card; as card; for terminal block width 5 - 17.5 mm; stretchable 5 - 5.2 mm; plain; snap-on type; violet

**Item No.: 793-5501**

WMB marking card; as card; for terminal block width 5 - 17.5 mm; stretchable 5 - 5.2 mm; plain; snap-on type; white



**Item No.: 793-5501/000-002**

WMB marking card; as card; for terminal block width 5 - 17.5 mm; stretchable 5 - 5.2 mm; plain; snap-on type; yellow

**Item No.: 793-501/000-006**

WMB marking card; as card; not stretchable; plain; snap-on type; blue

**Item No.: 793-501/000-007**

WMB marking card; as card; not stretchable; plain; snap-on type; gray

**Item No.: 793-501/000-023**

WMB marking card; as card; not stretchable; plain; snap-on type; green



**Item No.: 793-501/000-017**

WMB marking card; as card; not stretchable; plain; snap-on type; light green

**Item No.: 793-501/000-012**

WMB marking card; as card; not stretchable; plain; snap-on type; orange

**Item No.: 793-501/000-005**

WMB marking card; as card; not stretchable; plain; snap-on type; red

**Item No.: 793-501/000-024**

WMB marking card; as card; not stretchable; plain; snap-on type; violet

1.2.1.1 Marker



**Item No.: 793-501**

WMB marking card; as card; not stretchable; plain; snap-on type; white

**Item No.: 793-501/000-002**

WMB marking card; as card; not stretchable; plain; snap-on type; yellow

**Item No.: 2009-115/000-006**

WMB-Inline; for Smart Printer; 1500 pieces on roll; stretchable 5 - 5.2 mm; plain; snap-on type; blue

**Item No.: 2009-115/000-007**

WMB-Inline; for Smart Printer; 1500 pieces on roll; stretchable 5 - 5.2 mm; plain; snap-on type; gray



**Item No.: 2009-115/000-023**

WMB-Inline; for Smart Printer; 1500 pieces on roll; stretchable 5 - 5.2 mm; plain; snap-on type; green

**Item No.: 2009-115/000-017**

WMB-Inline; for Smart Printer; 1500 pieces on roll; stretchable 5 - 5.2 mm; plain; snap-on type; light green

**Item No.: 2009-115/000-012**

WMB-Inline; for Smart Printer; 1500 pieces on roll; stretchable 5 - 5.2 mm; plain; snap-on type; orange

**Item No.: 2009-115/000-024**

WMB-Inline; for Smart Printer; 1500 pieces on roll; stretchable 5 - 5.2 mm; plain; snap-on type; violet



**Item No.: 2009-115**

WMB-Inline; for Smart Printer; 1500 pieces on roll; stretchable 5 - 5.2 mm; plain; snap-on type; white

**Item No.: 2009-115/000-002**

WMB-Inline; for Smart Printer; 1500 pieces on roll; stretchable 5 - 5.2 mm; plain; snap-on type; yellow

1.2.1.2 Marking strip



**Item No.: 2009-110/762-802**

Marking strips; for Smart Printer; cut to a defined length; MARKED; Specialty printing; not stretchable; Horizontal marking; snap-on type; white

**Item No.: 2009-110/762-803**

Marking strips; for Smart Printer; cut to a defined length; MARKED; Specialty printing; not stretchable; Horizontal marking; snap-on type; white

**Item No.: 2009-110/762-804**

Marking strips; for Smart Printer; cut to a defined length; MARKED; Specialty printing; not stretchable; Horizontal marking; snap-on type; white

**Item No.: 2009-110/762-805**

Marking strips; for Smart Printer; cut to a defined length; MARKED; Specialty printing; not stretchable; Horizontal marking; snap-on type; white



**Item No.: 2009-110/762-806**

Marking strips; for Smart Printer; cut to a defined length; MARKED; Specialty printing; not stretchable; Horizontal marking; snap-on type; white

**Item No.: 2009-110/762-807**

Marking strips; for Smart Printer; cut to a defined length; MARKED; Specialty printing; not stretchable; Horizontal marking; snap-on type; white

**Item No.: 2009-110/762-808**

Marking strips; for Smart Printer; cut to a defined length; MARKED; Specialty printing; not stretchable; Horizontal marking; snap-on type; white

**Item No.: 2009-110**

Marking strips; for Smart Printer; on reel; not stretchable; plain; snap-on type; white

1.2.2 Strain relief

1.2.2.1 Strain relief plate



**Item No.: 831-506**

Strain relief plate; for female and male connectors; 51 mm wide; 1 part; Pin spacing 7.62 mm; light gray

1.2.3 Test and measurement

1.2.3.1 Testing accessories



**Item No.: 210-136**

Test plug; 2 mm Ø; with 500 mm cable; red

## 1.2.4 Tool

### 1.2.4.1 Operating tool



#### Item No.: 210-721

Operating tool; Blade: 5.5 x 0.8 mm; with a partially insulated shaft; multicoloured

## Installation Notes

### Conductor termination

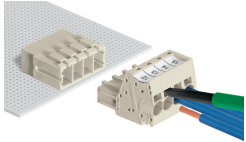

Inserting fine-stranded conductors via (5.5 x 0.8) mm screwdriver.

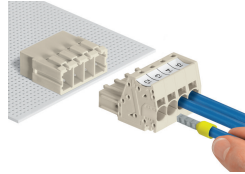

Solid and ferruled conductors are terminated by simply pushing them into unit.

## Testing

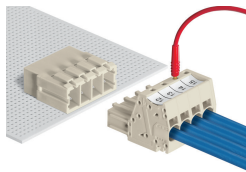

Testing with 2 mm Ø test plug.

## Coding

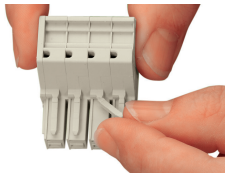

Break or cut off coding pin from female connector.

## Marking



Direct marking of female and male connectors



MCS MAXI male and female connectors can also be marked via Mini-WSB or WMB markers.