

Click to
ORDER
samples

AMED240-GY



DIN Rail

The AMED240-GY is a high efficiency DIN rail AC/DC converter that features a cost-effective design. Offering a commercial input voltage range of 90-264VAC and an output voltage range from 24-48V, this series will offer many benefits to your new system design. The converter measures 63.00 x 125.20 x 113.50mm and has ambient air-cooling vents both at the top and bottom of the converter for improved thermal performance. It is also easy to install and remove for maintenance, while efficiently organizing all your electrical cables.

This series offers great operating temperatures, from -25°C to 70°C and features an isolation of 3000VAC for improved reliability and system safety. Furthermore, a high MTBF of 986,300h, output over-load protection, output short circuit protection, over temperature protection (OTP), and output over-voltage protection (OVP) come standard with the series. A built in DC OK relay contact is integrated in the design.

The AMED240-GY is suitable for electric distribution boxes, grid power, instrumentation, CNC machines, industrial control panels and building automation applications.

Features

- Ultra-wide Input: 90 - 264VAC/127 - 370VDC
- Operating Temp: -25 °C to +70 °C
- High isolation voltage: 3000VAC
- Low ripple & noise, 120mV(p-p), max.
- Short circuit protection, over-voltage protection, over temperature protection, and overload protection.

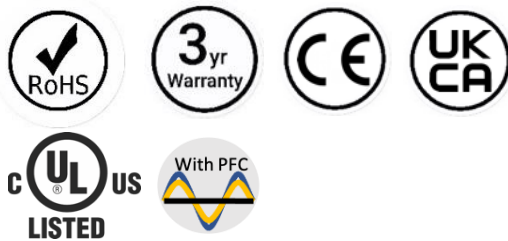

Summary

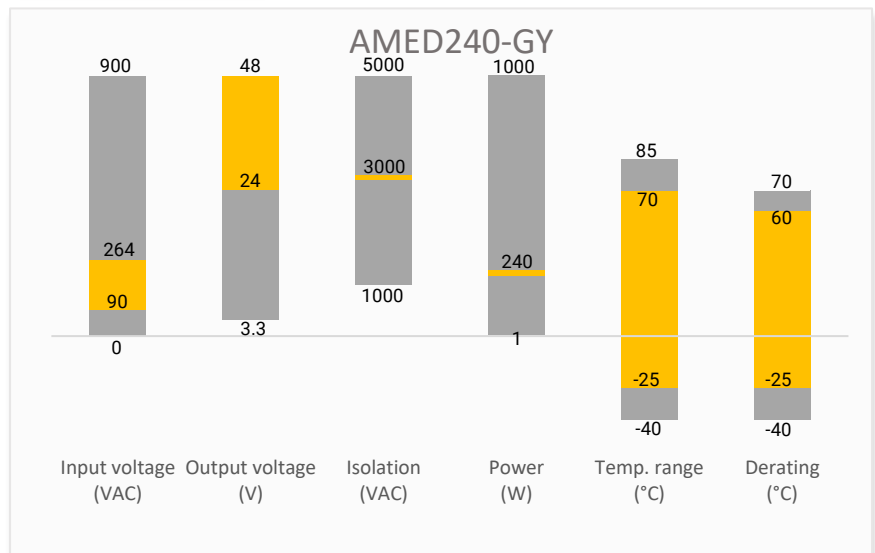

Training

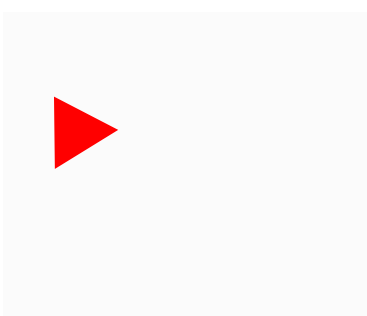

Product Training Video
(click to open)

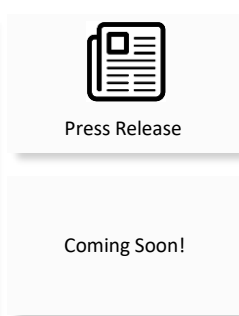

Application Notes

Applications



Power Grid



Industrial



Telecom

Models & Specifications

Model	Input Voltage (VAC/Hz)	Input Voltage (VDC)	Max Output wattage (W)	Output Voltage (V)	Output Current max (A)	Efficiency @ 230VAC Typ. (%)
AMED240-24SGY	90~264/47~63	127~370	240	24	10	90
AMED240-48SGY	90~264/47~63	127~370	240	48	5	93

Input Specifications

Parameters	Conditions	Typical	Maximum	Units
Input Current	115VAC		2.6	A
	230VAC		1.3	A
Inrush Current	115VAC, cold start	33		A
	230VAC, cold start	55		
Leakage Current	240VAC		< 1	mA
Power factor	115VAC, at full load	0.99		
	230VAC, at full load	0.94		

Output Specifications

Parameters	Conditions	Typical	Maximum	Units
Voltage accuracy	0 - 100% load	± 2		%
Line regulation	Rated load	± 0.5		%
Load regulation	0 - 100% load	± 1		%
Ripple & Noise*	24 VDC Output		100	mV p-p
	48 VDC Output		120	mV p-p
Start-up time	230VAC input, full load		0.65	s
	115VAC input, full load		1.3	s
Rise time	230VAC input, full load		60	ms
	115VAC input, full load		60	ms
Hold up time	230VAC input, full load	20		ms
	115VAC input, full load	20		ms
Voltage adjustable range	24 VDC Output	24 - 28		V
	48 VDC Output	48 - 55		V

* Ripple and Noise are measured at 20MHz bandwidth. Please refer to the application note for specific details. Measured with a 47μF electrolytic capacitor and a 0.1μF ceramic capacitor.

Isolation Specifications

Parameters	Conditions	Typical	Maximum	Units
Tested I/O voltage	60 sec, Leakage current < 10mA	3000		VAC
Tested Input to GND voltage	60 sec, Leakage current < 10mA	2000		VAC
Tested Output to GND voltage	60 sec, Leakage current < 10mA	500		VAC
Tested Output to P-G signal	60 sec, Leakage current < 2mA	500		VAC
Insulation resistance	I to O, I/O to PE, 500VDC, 25°C, 70%RH	>100		MΩ

General Specifications				
Parameters	Conditions	Typical	Maximum	Units
Over voltage protection	24 VDC Output, manual-recovery	≤ 33		VDC
	48 VDC Output, manual-recovery	≤ 65		VDC
Over temperature protection	Detected on heatsink power switch, auto-recovery	95 ± 5		°C
Overload protection	Works normally within 110 ~ 150% rated output power for more than 5 seconds, output voltage turns off, auto-recovery >150% rated output power, constant current limiting, auto-recovery within 5 seconds, shut down if over 3 seconds			
Short circuit protection	Hiccup, Continuous, auto-recovery			
Operating temperature	20 ~ 95% RH non-condensing	-25 to +70		°C
Storage temperature	10 ~ 95% RH	-40 to +85		°C
Power derating	230VAC, +60 °C to 70°C, For 3 sec.	3.75		% / °C
	230VAC, +60 °C to 70°C, Continuous	2.5		% / °C
	Input voltage derating, 90VAC - 100VAC	1.0		% / °C
Temperature coefficient	0 ~ 50 °C	± 0.03		% / °C
Cooling	Free air convection			
Operating Humidity	Non-condensing		< 95	% RH
Storage Humidity	Non-condensing		<95	% RH
Case material	Metal			
Weight		1000		g
Dimensions (L x W x H)	2.48 x 4.92 x 4.47 inches (63.00 x 125.00 x 113.50 mm)			
MTBF	986.3K hrs min. Telcordia SR-332(Bellcore)			
NOTE: All specifications in this datasheet are measured at an ambient temperature of 25°C, humidity<75%, nominal input voltage and at rated output load unless otherwise specified.				

Safety Specifications		
Parameters		
Agency approval	UL61010-1, UL61010-2-201, BS EN/EN61010-1	
Standards	EMC - Conducted and radiated emission	CISPR32 / EN55032, Class B
	Harmonic Current emission	IEC/EN 61000-3-2, Class A
	Voltage Fluctuations & Flicker	IEC/EN 61000-3-3
	Electrostatic Discharge Immunity	IEC/EN 61000-4-2 Contact ±4KV, Air ±8KV, Criteria B
	RF, Electromagnetic Field Immunity	IEC/EN 61000-4-3 3V/m, Criteria A
	Electrical Fast Transient/Burst Immunity	IEC/EN 61000-4-4 ±1KV, Criteria B
	Surge Immunity	IEC/EN 61000-4-5 L-L ±1KV, L-G ±2KV, Criteria B
	CS, Conducted Disturbance Immunity	IEC/EN 61000-4-6 3V, 3V~1V, 1V r.m.s, Criteria A
	Power Frequency Magnetic Field Immunity	IEC/EN 61000-4-8 50, 60Hz, Criteria A
	Voltage dips, Short Interruptions Immunity	IEC/EN 61000-4-11 100% Voltage Dips/Interruptions, 3 cycles, Criteria B
EMC Immunity	BS EN/EN55024, BS EN/EN61000-6-2(BS EN/EN50082-2), BS EN/EN61204-3, Heavy Industry Level	

Derating

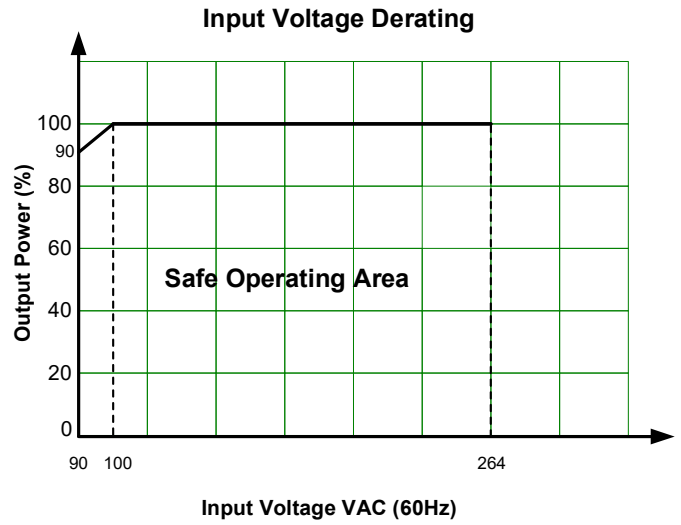
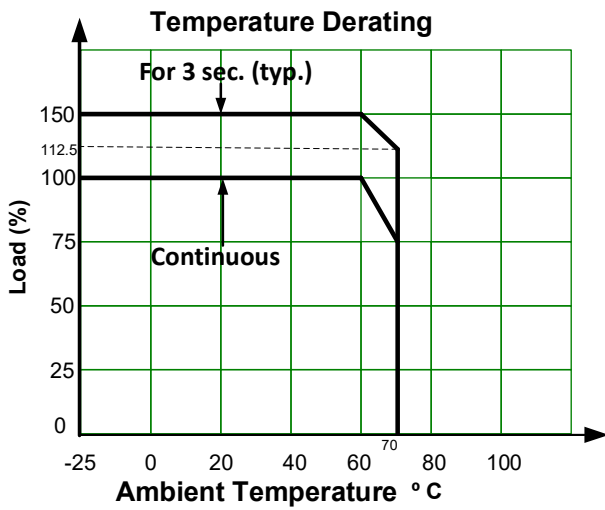

Dimensions

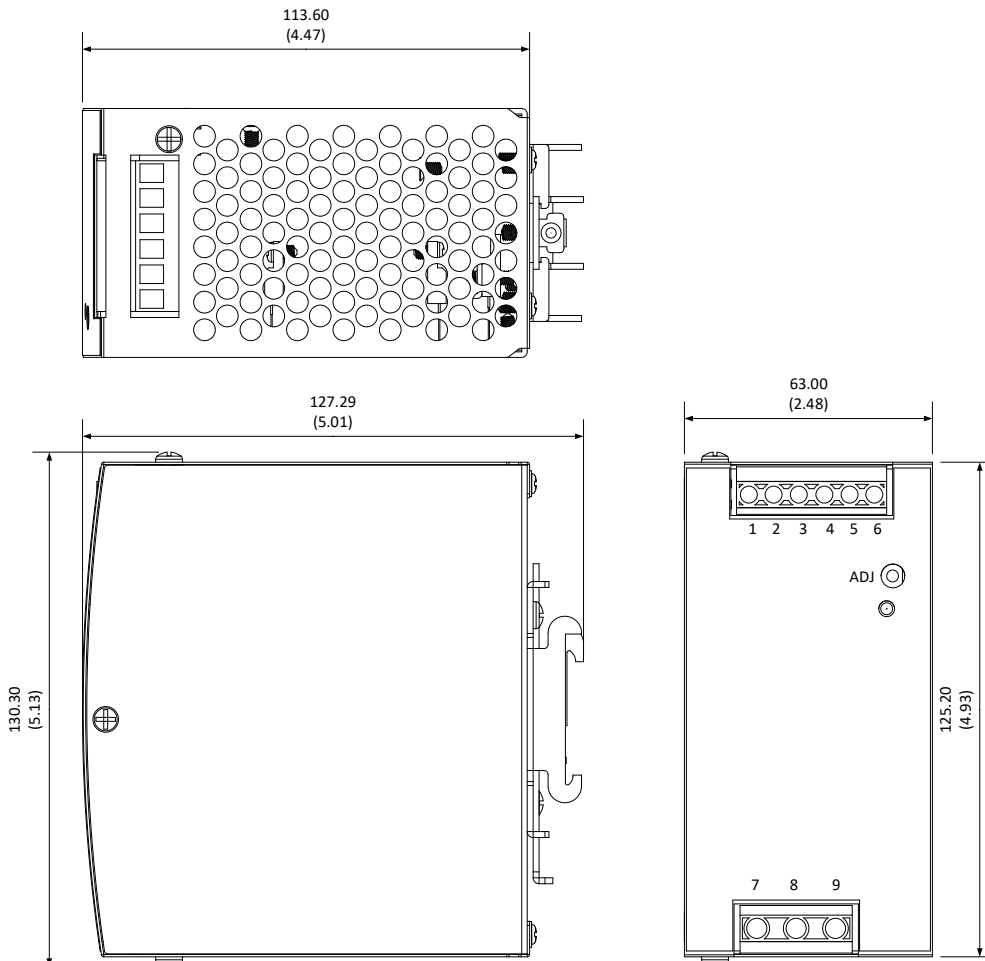

Pin Output Specifications	
Pin	Function
1	Relay Contact
2	Relay Contact
3	+V Output
4	+V Output
5	-V Output
6	-V Output
7	GND \equiv
8	N
9	L
ADJ	Voltage Adjustment

Functional Diagram

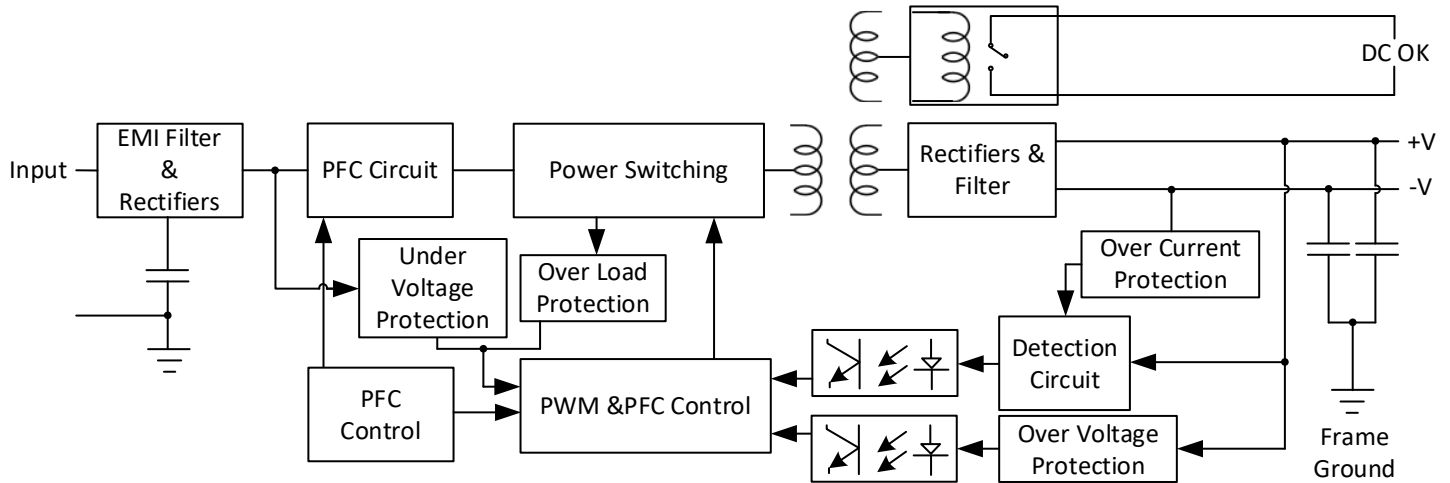

DC OK Relay Contact

Contact Closed	Power Supply Unit turns on / DC OK
Contact Open	Power Supply Unit turns off / DC FAIL
Contact Ratings (maximum)	30 V / 1 A resistive load

Peak Loading

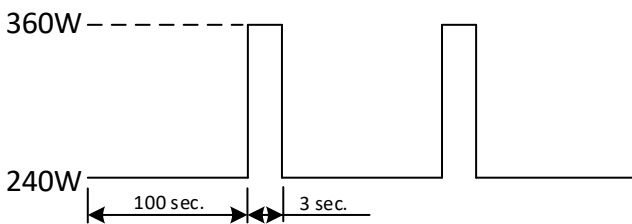

Full Load

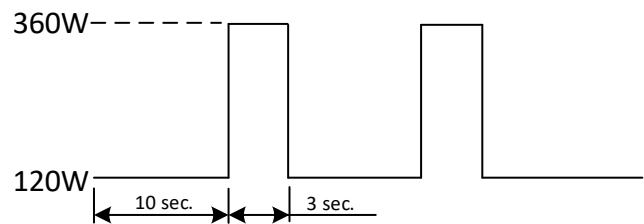

Half Load

NOTE: 1. Datasheets are updated as needed and as such, specifications are subject to change without notice. Once printed or downloaded, datasheets are no longer controlled by Aimtec; refer to www.aimtec.com for the most current product specifications. 2. Product labels shown, including safety agency certifications on labels, may vary based on the date manufactured. 3. Mechanical drawings and specifications are for reference only. 4. All specifications are measured at an ambient temperature of 25°C, humidity<75%, nominal input voltage and at rated output load unless otherwise specified. 5. Aimtec may not have conducted destructive testing or chemical analysis on all internal components and chemicals at the time of publishing this document. CAS numbers and other limited information are considered proprietary and may not be available for release. 6. This product is not designed for use in critical life support systems, equipment used in hazardous environments, nuclear control systems or other such applications which necessitate specific safety and regulatory standards other the ones listed in this datasheet. 7. Warranty is in accordance with Aimtec's standard Terms of Sale available at www.aimtec.com.