

Data Sheet | Item Number: 2002-1306

3-conductor through terminal block; 2.5 mm²; suitable for Ex e II applications; side and center marking; for DIN-rail 35 x 15 and 35 x 7.5; Push-in CAGE CLAMP®; 2,50 mm²; yellow

<https://www.wago.com/2002-1306>

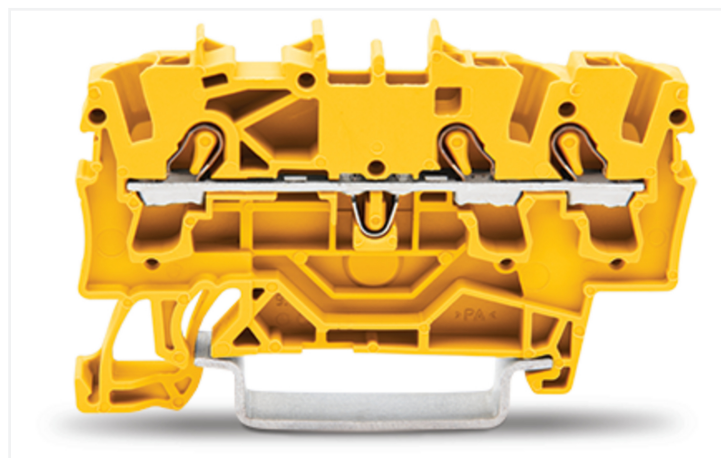
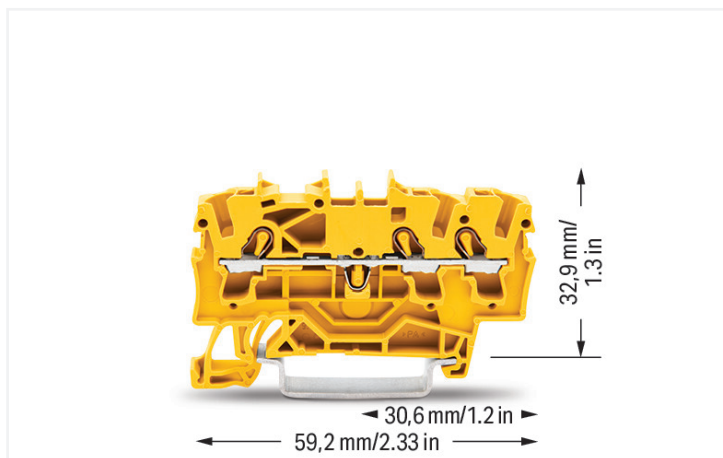

Color: ■ yellow

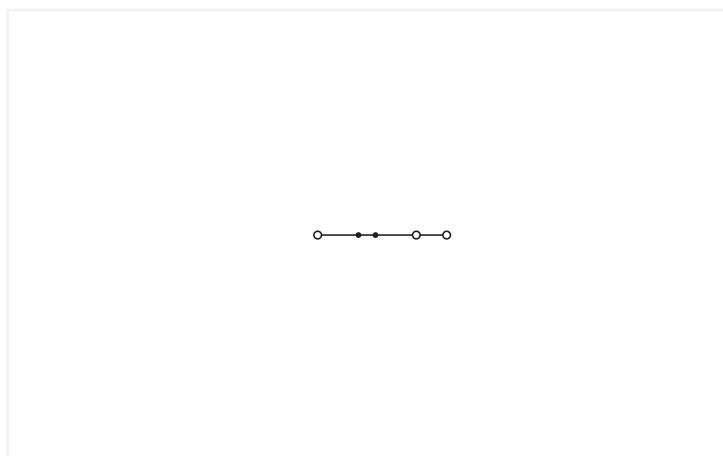

Similar to illustration

Through terminal block, 2002 Series, Push-in CAGE CLAMP®

Our through terminal block (item number 2002-1306) is the ideal way to connect conductors quickly and securely. Ensure that the strip lengths are between 10 and 12 mm when connecting conductors to this through terminal block. Whether for use in industry or building installations, our rail-mount through terminal blocks make it easy to quickly and securely connect electrical conductors. They're perfect for either classic through-wiring or distributing potential, depending on the variant. Featuring conductor terminals along with Push-in CAGE CLAMP®, this connector delivers reliable performance. Push-in CAGE CLAMP® connection technology is ideal for connecting all conductor types. It allows direct insertion of both solid and fine-stranded conductors with ferrules without the need for tools—all thanks to its pluggable design. Dimensions: (5.2 x 59.2 x 39.5) mm (width x height x depth). Depending on the conductor type, this through terminal block is suitable for conductor cross sections ranging from 0.25 mm² to 4 mm².

An operating tool is used to operate this through rail-mount terminal block. Our TOPJOB® S rail-mount terminal blocks guarantee secure electrical connections in various industrial applications and modern building installations. They simplify wiring, as you can quickly plug in solid, stranded, and fine-stranded conductors with ferrules. This product is designed for specific Ex applications (please refer to the product datasheet).

Electrical data

Ratings per	IEC/EN 60947-7-1		
Overvoltage category	III	III	II
Pollution degree	3	2	2
Nominal voltage	800 V	-	-
Rated impulse withstand voltage	8 kV	-	-
Rated current	24 A	-	-
Current at conductor cross-section (max.) mm ²	32 A	-	-

Approvals per	UL 1059		
Use group	B	C	D
Rated voltage	600 V	600 V	-
Rated current	20 A	20 A	-

Approvals per	CSA 22.2 No 158		
Use group	B	C	D
Rated voltage	600 V	600 V	-
Rated current	20 A	20 A	-

Ex information	
Reference to hazardous areas	See application instructions in section "Knowledge and Downloads – Documentation – Additional Information: Technical Section; Technical Explanations"
Ratings per	ATEX: PTB 03 ATEX 1162 U / IECEx: PTB 03.0004U (Ex eb IIC Gb)
Rated voltage EN (Ex e II)	550 V
Rated current (Ex e II)	22 A
Rated current (Ex e II) with jumper	20 A

Power Loss

Power loss, per pole (potential)	0.7661 W
Rated current I_N for power loss specification	24 A
Resistance value for specified, current-dependent power loss	0.00133 Ω

General information

Wiring direction	Front-entry wiring
------------------	--------------------

Connection Data

Clamping units	3
Total number of potentials	1
Number of levels	1
Number of jumper slots	2

Connection 1	
Connection technology	Push-in CAGE CLAMP®
Actuation type	Operating tool
Connectable conductor materials	Copper
Nominal cross-section	2.5 mm ²
Solid conductor	0.25 ... 4 mm ² / 22 ... 12 AWG
Solid conductor; push-in termination	0.75 ... 4 mm ² / 18 ... 12 AWG
Fine-stranded conductor	0.25 ... 4 mm ² / 22 ... 12 AWG
Fine-stranded conductor; with insulated ferrule	0.25 ... 2.5 mm ² / 22 ... 14 AWG
Fine-stranded conductor; with ferrule; push-in termination	1 ... 2.5 mm ² / 18 ... 14 AWG
Note (conductor cross-section)	Depending on the conductor characteristic, a conductor with a smaller cross-section can also be inserted via push-in termination.
Strip length	10 ... 12 mm / 0.39 ... 0.47 inches
Wiring direction	Front-entry wiring

Physical data

Width	5.2 mm / 0.205 inches
Height	59.2 mm / 2.33 inches
Depth from upper-edge of DIN-rail	32.9 mm / 1.295 inches
Depth	39.5 mm / 1.555 inches

Mechanical data

Mounting type	DIN-35 rail
Marking level	Center/side marking

Material data

Note (material data)	Information on material specifications can be found here
Color	yellow
Material group	I
Insulation material (main housing)	Polyamide (PA66)
Flammability class per UL94	V0
Fire load	0.117 MJ
Weight	6.2 g

Environmental requirements

Processing temperature	-35 ... +85 °C
Continuous operating temperature	-60 ... +105 °C

Environmental Testing

Test specification: Railway applications – Rolling stock – Electronic equipment	DIN EN 50155 (VDE 0115-200):2022-06
Test procedure: Railway applications – Rolling stock equipment – Vibration and shock tests	DIN EN 61373 (VDE 0115-0106):2011-04
Spectrum/Mounting location	Service life test, Category 1, Class A/B
Functional test with noise-like oscillations	Test passed according to Section 8 of the standard
Frequency	$f_1 = 5 \text{ Hz}$ to $f_2 = 150 \text{ Hz}$
Acceleration	0.101g (highest test level used for all axes)
Test duration per axis	10 min.
Test directions	X, Y and Z axes
Monitoring of contact faults and interruptions	Passed
Voltage drop measurement before and after each axis	Passed
Simulated service life test through increased levels of noise-like oscillations	Test passed according to Section 9 of the standard
Frequency	$f_1 = 5 \text{ Hz}$ to $f_2 = 150 \text{ Hz}$
Acceleration	0.572g (highest test level used for all axes)
Test duration per axis	5 h
Test directions	X, Y and Z axes
Extended testing: Monitoring of contact faults and interruptions	Passed
Extended testing: Voltage drop measurement before and after each axis	Passed
Shock test	Test passed according to Section 10 of the standard
Shock pulse form	Half sine
Acceleration	5g (highest test level used for all axes)
Shock duration	30 ms
Number of shocks (per axis)	3 pos. und 3 neg.
Test directions	X, Y and Z axes

Environmental Testing

Extended testing: Monitoring of contact faults and interruptions	Passed
Extended testing: Voltage drop measurement before and after each axis	Passed
Vibration and shock stress for rolling stock equipment	Passed

Commercial data

Product Group	22 (TOPJOB S)
PU (SPU)	100 pcs
Packaging type	Box
Country of origin	DE
GTIN	4044918081535
Customs tariff number	85369010000

Product Classification

UNSPSC	39121410
eCl@ss 10.0	27-14-11-20
eCl@ss 9.0	27-14-11-20
ETIM 9.0	EC000897
ETIM 10.0	EC000897
ECCN	NO US CLASSIFICATION

Environmental Product Compliance

RoHS Compliance Status	Compliant, No Exemption
------------------------	-------------------------

Approvals / Certificates

General approvals



Approval	Standard	Certificate Name
CCA DEKRA Certification B.V.	EN 60947	NTR NL-8054
CSA CSA Group	C22.2 No. 158	154112
DEKRA DEKRA Certification B.V.	EN 60947	71-149763
KEMA/KEUR DEKRA Certification B.V.	EN 60947	71-124163
UL Underwriters Laboratories Inc.	UL 1059	E45172

Declarations of conformity and manufacturer's declarations



Approval	Standard	Certificate Name
ATEX-Attestation of Conformity WAGO GmbH & Co. KG	-	-
EU-Declaration of Conformity WAGO GmbH & Co. KG	-	-
Railway WAGO GmbH & Co. KG	-	Railway Ready
UK-Declaration of Conformity WAGO GmbH & Co. KG	-	-

Approvals for marine applications



Approval	Standard	Certificate Name
ABS American Bureau of Shipping	EN 60947	24-0152298-PDA
DNV GL Det Norske Veritas, Germanischer Lloyd	-	TAE00001V2
PRS Polski Rejestr Statków	-	TE/1094/880590/23

Approvals for hazardous areas



Approval	Standard	Certificate Name
AEx Underwriters Laboratories Inc.	UL 60079	E185892 (AEx eb IIC resp. Ex eb IIC)
ATEX Physikalisch Technische Bundesanstalt	EN 60079	PTB 03 ATEX 1162 U (II2G Ex eb IIC Gb, IM2 Ex eb IMb)
CCC CQST/CNEC	GB/T 3836.3	2020312313000238 (Ex eb IIC Gb, Ex eb I Mb)
IECEX Physikalisch Technische Bundesanstalt	IEC 60079	IECEX PTB 03.0004U (Ex eb IIC Gb or Ex eb I Mb)
INMETRO TÜV Rheinland do Brasil Ltda.	IEC 60079	TÜV 12.1307 U

Downloads

Environmental Product Compliance

Compliance Search

Environmental Product Compliance 2002-1306



Documentation

Bid Text

2002-1306	29.04.2019	xml 4.15 KB	
2002-1306	23.04.2019	docx 14.90 KB	

CAD/CAE-Data

CAD data

2D/3D Models
2002-1306



CAE data

EPLAN Data Portal
2002-1306



WSCAD Universe
2002-1306



ZUKEN Portal 2002-1306



1 Compatible Products

1.1 Required Accessories

1.1.1 End plate

1.1.1.1 End plate



Item No.: 2002-1391

End and intermediate plate; 0.8 mm thick; gray



Item No.: 2002-1392

End and intermediate plate; 0.8 mm thick; orange



Item No.: 209-191

Separator for Ex e/Ex i applications; 3 mm thick; 120 mm wide; orange

1.2 Optional Accessories

1.2.1 DIN-rail

1.2.1.1 Mounting accessories



Item No.: 210-196

Aluminum carrier rail; 35 x 8.2 mm; 1.6 mm thick; 2 m long; unslotted; similar to EN 60715; silver-colored



Item No.: 210-198

Copper carrier rail; 35 x 15 mm; 2.3 mm thick; 2 m long; unslotted; according to EN 60715; copper-colored



Item No.: 210-508

Steel carrier rail; 35 x 15 mm; 1.5 mm thick; 2 m long; slotted; galvanized; similar to EN 60715; silver-colored



Item No.: 210-197

Steel carrier rail; 35 x 15 mm; 1.5 mm thick; 2 m long; slotted; similar to EN 60715; silver-colored



Item No.: 210-506

Steel carrier rail; 35 x 15 mm; 1.5 mm thick; 2 m long; unslotted; galvanized; similar to EN 60715; silver-colored



Item No.: 210-114

Steel carrier rail; 35 x 15 mm; 1.5 mm thick; 2 m long; unslotted; similar to EN 60715; silver-colored



Item No.: 210-118

Steel carrier rail; 35 x 15 mm; 2.3 mm thick; 2 m long; unslotted; according to EN 60715; silver-colored



Item No.: 210-115

Steel carrier rail; 35 x 7.5 mm; 1 mm thick; 2 m long; slotted; according to EN 60715; "Hole width 18 mm; silver-colored



Item No.: 210-112

Steel carrier rail; 35 x 7.5 mm; 1 mm thick; 2 m long; slotted; according to EN 60715; "Hole width 25 mm; silver-colored



Item No.: 210-504

Steel carrier rail; 35 x 7.5 mm; 1 mm thick; 2 m long; slotted; galvanized; according to EN 60715; silver-colored



Item No.: 210-113

Steel carrier rail; 35 x 7.5 mm; 1 mm thick; 2 m long; unslotted; according to EN 60715; silver-colored



Item No.: 210-505

Steel carrier rail; 35 x 7.5 mm; 1 mm thick; 2 m long; unslotted; galvanized; according to EN 60715; silver-colored

1.2.2 End plate

1.2.2.1 End plate



Item No.: 2002-1393

Separator plate; 2 mm thick; oversized; gray



Item No.: 2002-1394

Separator plate; 2 mm thick; oversized; orange

1.2.3 Ferrule

1.2.3.1 Ferrule



Item No.: 216-241

Ferrule; Sleeve for 0.5 mm² / 20 AWG; insulated; electro-tin plated; electrolytic copper; gastight crimped; acc. to DIN 46228, Part 4/09.90; white



Item No.: 216-242

Ferrule; Sleeve for 0.75 mm² / 18 AWG; insulated; electro-tin plated; electrolytic copper; gastight crimped; acc. to DIN 46228, Part 4/09.90; gray



Item No.: 216-262

Ferrule; Sleeve for 0.75 mm² / 18 AWG; insulated; electro-tin plated; electrolytic copper; gastight crimped; acc. to DIN 46228, Part 4/09.90; gray



Item No.: 216-243

Ferrule; Sleeve for 1 mm² / AWG 18; insulated; electro-tin plated; electrolytic copper; gastight crimped; acc. to DIN 46228, Part 4/09.90; red

1.2.3.1 Ferrule



Item No.: 216-263
 Ferrule; Sleeve for 1 mm² / AWG 18; insulated; electro-tin plated; electrolytic copper; gastight crimped; acc. to DIN 46228, Part 4/09.90; red

Item No.: 216-244
 Ferrule; Sleeve for 1.5 mm² / AWG 16; insulated; electro-tin plated; electrolytic copper; gastight crimped; acc. to DIN 46228, Part 4/09.90; black

Item No.: 216-264
 Ferrule; Sleeve for 1.5 mm² / AWG 16; insulated; electro-tin plated; electrolytic copper; gastight crimped; acc. to DIN 46228, Part 4/09.90; black

Item No.: 216-246
 Ferrule; Sleeve for 2.5 mm² / AWG 14; insulated; electro-tin plated; electrolytic copper; gastight crimped; acc. to DIN 46228, Part 4/09.90; blue



Item No.: 216-266
 Ferrule; Sleeve for 2.5 mm² / AWG 14; insulated; electro-tin plated; electrolytic copper; gastight crimped; acc. to DIN 46228, Part 4/09.90; blue

1.2.4 Installation

1.2.4.1 Cover



Item No.: 709-156
 Cover; Type 3; suitable for cover carrier, type 3; 1 m long; transparent

1.2.4.2 Cover carrier



Item No.: 709-169
 Cover carrier; Type 3; incl. fixing/retaining screws and knurled nut; suitable for 279 to 282 and 880 Series rail-mounted terminal blocks; suitable for 264 Series miniature rail-mounted terminal blocks; suitable for 270 Series sensor and actuator terminal blocks; gray

1.2.5 Insulation stop

1.2.5.1 Insulation stop



Item No.: 2002-171
 Insulation stop; 0.25 - 0.5 mm²; 5 pieces/strip; light gray

Item No.: 2002-172
 Insulation stop; 0.75 - 1 mm²; 5 pieces/strip; dark gray

1.2.6 Jumper

1.2.6.1 Jumper



Item No.: 2002-400
 Continuous jumper; 2-way; insulated; light gray

Item No.: 2002-413
 Continuous jumper; 3-way; insulated; light gray

Item No.: 2002-415
 Continuous jumper; 5-way; insulated; light gray

Item No.: 2002-423/000-006
 Continuous jumper; from 1 to 3; insulated; blue



























































Item No.: 2002-423
 Continuous jumper; from 1 to 3; insulated; light gray

Item No.: 2002-423/000-005
 Continuous jumper; from 1 to 3; insulated; red

Item No.: 2002-424/000-006
 Continuous jumper; from 1 to 4; insulated; blue

Item No.: 2002-424
 Continuous jumper; from 1 to 4; insulated; light gray

1.2.6.1 Jumper

 Item No.: 2002-424/000-005 Continuous jumper; from 1 to 4; insulated; red	 Item No.: 2002-406/020-000 Delta jumper; insulated; light gray	 Item No.: 2002-410/000-006 Jumper; 10-way; insulated; blue	 Item No.: 2002-410 Jumper; 10-way; insulated; light gray
 Item No.: 2002-410/000-005 Jumper; 10-way; insulated; red	 Item No.: 2002-402/000-006 Jumper; 2-way; insulated; blue	 Item No.: 2002-402 Jumper; 2-way; insulated; light gray	 Item No.: 2002-402/000-005 Jumper; 2-way; insulated; red
 Item No.: 2002-403/000-006 Jumper; 3-way; insulated; blue	 Item No.: 2002-403 Jumper; 3-way; insulated; light gray	 Item No.: 2002-403/000-005 Jumper; 3-way; insulated; red	 Item No.: 2002-404/000-006 Jumper; 4-way; insulated; blue
 Item No.: 2002-404 Jumper; 4-way; insulated; light gray	 Item No.: 2002-404/000-005 Jumper; 4-way; insulated; red	 Item No.: 2002-405/000-006 Jumper; 5-way; insulated; blue	 Item No.: 2002-405 Jumper; 5-way; insulated; light gray
 Item No.: 2002-405/000-005 Jumper; 5-way; insulated; red	 Item No.: 2002-406/000-006 Jumper; 6-way; insulated; blue	 Item No.: 2002-406 Jumper; 6-way; insulated; light gray	 Item No.: 2002-406/000-005 Jumper; 6-way; insulated; red
 Item No.: 2002-407/000-006 Jumper; 7-way; insulated; blue	 Item No.: 2002-407 Jumper; 7-way; insulated; light gray	 Item No.: 2002-407/000-005 Jumper; 7-way; insulated; red	 Item No.: 2002-408/000-006 Jumper; 8-way; insulated; blue
 Item No.: 2002-408 Jumper; 8-way; insulated; light gray	 Item No.: 2002-408/000-005 Jumper; 8-way; insulated; red	 Item No.: 2002-409/000-006 Jumper; 9-way; insulated; blue	 Item No.: 2002-409 Jumper; 9-way; insulated; light gray
 Item No.: 2002-409/000-005 Jumper; 9-way; insulated; red	 Item No.: 2002-440 Jumper; from 1 to 10; insulated; light gray	 Item No.: 2002-433 Jumper; from 1 to 3; insulated; light gray	 Item No.: 2002-434 Jumper; from 1 to 4; insulated; light gray
 Item No.: 2002-435 Jumper; from 1 to 5; insulated; light gray	 Item No.: 2002-436 Jumper; from 1 to 6; insulated; light gray	 Item No.: 2002-437 Jumper; from 1 to 7; insulated; light gray	 Item No.: 2002-438 Jumper; from 1 to 8; insulated; light gray
 Item No.: 2002-439 Jumper; from 1 to 9; insulated; light gray	 Item No.: 2002-480 Staggered jumper; 10-way; insulated; light gray	 Item No.: 2002-481 Staggered jumper; 11-way; insulated; light gray	 Item No.: 2002-482 Staggered jumper; 12-way; insulated; light gray
 Item No.: 2002-473/011-000 Staggered jumper; 2-way; from 1 to 3; insulated; light gray	 Item No.: 2002-472 Staggered jumper; 2-way; insulated; light gray	 Item No.: 2002-473 Staggered jumper; 3-way; insulated; light gray	 Item No.: 2002-475/011-000 Staggered jumper; 3-way; insulated; light gray
 Item No.: 2002-474 Staggered jumper; 4-way; insulated; light gray	 Item No.: 2002-475 Staggered jumper; 5-way; insulated; light gray	 Item No.: 2002-476 Staggered jumper; 6-way; insulated; light gray	 Item No.: 2002-477 Staggered jumper; 7-way; insulated; light gray
 Item No.: 2002-478 Staggered jumper; 8-way; insulated; light gray	 Item No.: 2002-479 Staggered jumper; 9-way; insulated; light gray	 Item No.: 2002-477/011-000 Staggered jumper; insulated; light gray	 Item No.: 2002-479/011-000 Staggered jumper; insulated; light gray
 Item No.: 2002-481/011-000 Staggered jumper; insulated; light gray	 Item No.: 2002-405/011-000 Star point jumper; 3-way; insulated; light gray	 Item No.: 2006-499 Step-down jumper; from 2006/2004 to 2004/2002/2001 series; from 2206/2204 to 2204/2202/2201 series; insulated; light gray	 Item No.: 2016-499 Step-down jumper; from 2016/2010 to 2010/2006/2004/2002 series; from 2216/2210 to 2210/2206/2204/2202 series; insulated; light gray

1.2.6.1 Jumper



Item No.: 210-103

Wire commoning chain; 0.5 mm²; insulated; black

Item No.: 210-123

Wire commoning chain; insulated; blue

1.2.7 Marking

1.2.7.1 Group marker carrier



Item No.: 2009-191

Group marker carrier; gray

Item No.: 2009-192

Group marker carrier; gray

Item No.: 2009-193

Group marker carrier; gray

1.2.7.2 Marker

Item No.: 2009-145/000-006

Mini-WSB Inline; for Smart Printer; 1700 pieces on roll; stretchable 5 - 5.2 mm; plain; snap-on type; blue

Item No.: 2009-145/000-007

Mini-WSB Inline; for Smart Printer; 1700 pieces on roll; stretchable 5 - 5.2 mm; plain; snap-on type; gray

Item No.: 2009-145/000-023

Mini-WSB Inline; for Smart Printer; 1700 pieces on roll; stretchable 5 - 5.2 mm; plain; snap-on type; green

Item No.: 2009-145/000-012

Mini-WSB Inline; for Smart Printer; 1700 pieces on roll; stretchable 5 - 5.2 mm; plain; snap-on type; orange

Item No.: 2009-145/000-005

Mini-WSB Inline; for Smart Printer; 1700 pieces on roll; stretchable 5 - 5.2 mm; plain; snap-on type; red

Item No.: 2009-145/000-024

Mini-WSB Inline; for Smart Printer; 1700 pieces on roll; stretchable 5 - 5.2 mm; plain; snap-on type; violet

Item No.: 2009-145

Mini-WSB Inline; for Smart Printer; 1700 pieces on roll; stretchable 5 - 5.2 mm; plain; snap-on type; white

Item No.: 2009-145/000-002

Mini-WSB Inline; for Smart Printer; 1700 pieces on roll; stretchable 5 - 5.2 mm; plain; snap-on type; yellow



Item No.: 248-501/000-006

Mini-WSB marking card; as card; not stretchable; plain; snap-on type; blue

Item No.: 248-501/000-007

Mini-WSB marking card; as card; not stretchable; plain; snap-on type; gray

Item No.: 248-501/000-023

Mini-WSB marking card; as card; not stretchable; plain; snap-on type; green

Item No.: 248-501/000-017

Mini-WSB marking card; as card; not stretchable; plain; snap-on type; light green



Item No.: 248-501/000-012

Mini-WSB marking card; as card; not stretchable; plain; snap-on type; orange

Item No.: 248-501/000-005

Mini-WSB marking card; as card; not stretchable; plain; snap-on type; red

Item No.: 248-501/000-024

Mini-WSB marking card; as card; not stretchable; plain; snap-on type; violet

Item No.: 248-501

Mini-WSB marking card; as card; not stretchable; plain; snap-on type; white



Item No.: 248-501/000-002

Mini-WSB marking card; as card; not stretchable; plain; snap-on type; yellow

Item No.: 793-5501/000-006

WMB marking card; as card; for terminal block width 5 - 17.5 mm; stretchable 5 - 5.2 mm; plain; snap-on type; blue

Item No.: 793-5501/000-014

WMB marking card; as card; for terminal block width 5 - 17.5 mm; stretchable 5 - 5.2 mm; plain; snap-on type; brown

Item No.: 793-5501/000-007

WMB marking card; as card; for terminal block width 5 - 17.5 mm; stretchable 5 - 5.2 mm; plain; snap-on type; gray



Item No.: 793-5501/000-023

WMB marking card; as card; for terminal block width 5 - 17.5 mm; stretchable 5 - 5.2 mm; plain; snap-on type; green

Item No.: 793-5501/000-017

WMB marking card; as card; for terminal block width 5 - 17.5 mm; stretchable 5 - 5.2 mm; plain; snap-on type; light green

Item No.: 793-5501/000-012

WMB marking card; as card; for terminal block width 5 - 17.5 mm; stretchable 5 - 5.2 mm; plain; snap-on type; orange

Item No.: 793-5501/000-005

WMB marking card; as card; for terminal block width 5 - 17.5 mm; stretchable 5 - 5.2 mm; plain; snap-on type; red



Item No.: 793-5501/000-024

WMB marking card; as card; for terminal block width 5 - 17.5 mm; stretchable 5 - 5.2 mm; plain; snap-on type; violet

Item No.: 793-5501

WMB marking card; as card; for terminal block width 5 - 17.5 mm; stretchable 5 - 5.2 mm; plain; snap-on type; white

Item No.: 793-5501/000-002

WMB marking card; as card; for terminal block width 5 - 17.5 mm; stretchable 5 - 5.2 mm; plain; snap-on type; yellow

Item No.: 2009-115/000-006

WMB-Inline; for Smart Printer; 1500 pieces on roll; stretchable 5 - 5.2 mm; plain; snap-on type; blue



Item No.: 2009-115/000-007

WMB-Inline; for Smart Printer; 1500 pieces on roll; stretchable 5 - 5.2 mm; plain; snap-on type; gray

Item No.: 2009-115/000-023

WMB-Inline; for Smart Printer; 1500 pieces on roll; stretchable 5 - 5.2 mm; plain; snap-on type; green

Item No.: 2009-115/000-017

WMB-Inline; for Smart Printer; 1500 pieces on roll; stretchable 5 - 5.2 mm; plain; snap-on type; light green

Item No.: 2009-115/000-012

WMB-Inline; for Smart Printer; 1500 pieces on roll; stretchable 5 - 5.2 mm; plain; snap-on type; orange

1.2.7.2 Marker



Item No.: 2009-115/000-005

WMB-Inline; for Smart Printer; 1500 pieces on roll; stretchable 5 - 5.2 mm; plain; snap-on type; red



Item No.: 2009-115/000-024

WMB-Inline; for Smart Printer; 1500 pieces on roll; stretchable 5 - 5.2 mm; plain; snap-on type; violet



Item No.: 2009-115

WMB-Inline; for Smart Printer; 1500 pieces on roll; stretchable 5 - 5.2 mm; plain; snap-on type; white



Item No.: 2009-115/000-002

WMB-Inline; for Smart Printer; 1500 pieces on roll; stretchable 5 - 5.2 mm; plain; snap-on type; yellow

1.2.7.3 Marker carrier



Item No.: 2002-161

Adaptor; gray



Item No.: 2009-198

Adaptor; gray

1.2.7.4 Marking strip



Item No.: 2009-110

Marking strips; for Smart Printer; on reel; not stretchable; plain; snap-on type; white

1.2.8 Plug

1.2.8.1 Component module with diode



Item No.: 2002-880/1000-411

Component plug; 2-pole; with diode 1N4007; 10.4 mm wide; Operating temperature 85°C max.; gray

1.2.8.2 Component module with LED



Item No.: 2002-880/1000-541

Component plug; 2-pole; LED (red); 10.4 mm wide; Operating temperature 85°C max.; gray



Item No.: 2002-880/1000-836

Component plug; 2-pole; LED (red); 10.4 mm wide; Operating temperature 85°C max.; gray



Item No.: 2002-880/1000-542

Component plug; 2-pole; LED (red); 10.4 mm wide; Operating temperature 85°C max.; multicoloured

1.2.8.3 Empty component plug housing



Item No.: 2002-880

Empty component plug housing; 10.4 mm wide; 2-pole; Type 4; gray

1.2.9 Protective warning marker

1.2.9.1 Cover



Item No.: 2002-115

Protective warning marker; for 5 terminal blocks; with high-voltage symbol, black; yellow

1.2.10 Push-in type wire jumper

1.2.10.1 Jumper



Item No.: 2009-414

Push-in type wire jumper; 1.5 mm²; insulated; 110 mm long; black



Item No.: 2009-414/000-005

Push-in type wire jumper; 1.5 mm²; insulated; 110 mm long; black



Item No.: 2009-416

Push-in type wire jumper; 1.5 mm²; insulated; 250 mm long; black



Item No.: 2009-414/000-006

Push-in type wire jumper; insulated; 110 mm long; black



Item No.: 2009-412

Push-in type wire jumper; insulated; 60 mm long; black

1.2.11 Screwless end stop

1.2.11.1 Mounting accessories



Item No.: 249-117

Screwless end stop; 10 mm wide; for DIN-rail 35 x 15 and 35 x 7.5; gray



Item No.: 249-116

Screwless end stop; 6 mm wide; for DIN-rail 35 x 15 and 35 x 7.5; gray

1.2.12 Test and measurement

1.2.12.1 Testing accessories



Item No.: 2002-560

Modular TOPJOB*S connector; modular; for jumper contact slot; 10-pole; gray



Item No.: 2002-511

Modular TOPJOB*S connector; modular; for jumper contact slot; 1-pole; gray



Item No.: 2002-552

Modular TOPJOB*S connector; modular; for jumper contact slot; 2-pole; gray



Item No.: 2002-553

Modular TOPJOB*S connector; modular; for jumper contact slot; 3-pole; gray



Item No.: 2002-554

Modular TOPJOB*S connector; modular; for jumper contact slot; 4-pole; gray



Item No.: 2002-555

Modular TOPJOB*S connector; modular; for jumper contact slot; 5-pole; gray



Item No.: 2002-556

Modular TOPJOB*S connector; modular; for jumper contact slot; 6-pole; gray



Item No.: 2002-557

Modular TOPJOB*S connector; modular; for jumper contact slot; 7-pole; gray



Item No.: 2002-558

Modular TOPJOB*S connector; modular; for jumper contact slot; 8-pole; gray



Item No.: 2002-559

Modular TOPJOB*S connector; modular; for jumper contact slot; 9-pole; gray



Item No.: 2002-549

Spacer module; modular; e.g., for bridging commoned terminal blocks; gray



Item No.: 2009-174

Test plug adapter; for 4 mm Ø test plugs; for testing TOPJOB*S rail-mounted terminal blocks; gray



Item No.: 2009-182

Testing tap; for max. 2.5 mm²; tool-free connection for individual test wires 0.08 - 2.5 mm; gray



Item No.: 2002-649

TOPJOB*S L-type spacer module; modular; e.g., for bridging commoned terminal blocks; gray



Item No.: 2002-611

TOPJOB*S L-type test plug module; modular; 1-pole; gray

1.2.13 Tool

1.2.13.1 Operating tool



Item No.: 210-658

Operating tool; Blade: 3.5 x 0.5 mm; with a partially insulated shaft; angled; short; multi-coloured

Item No.: 210-720

Operating tool; Blade: 3.5 x 0.5 mm; with a partially insulated shaft; multicoloured

Installation Notes

Conductor termination



All conductor types at a glance

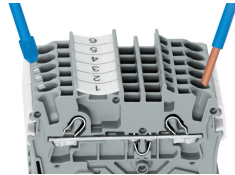

Push-in termination of solid and ferruled conductors

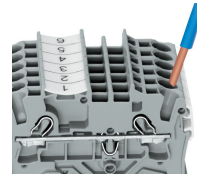

Inserting a conductor via push-in termination:

Solid conductors with cross-sections from either one size above, or up to two sizes below, the rated cross-section can be simply pushed in – no tools needed.

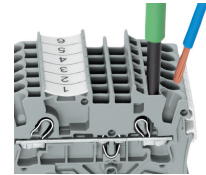

Inserting a conductor via operating tool:

Connecting fine-stranded conductors without ferrules, or small cross-sectional conductors that cannot be pushed in, is performed similarly to the original CAGE CLAMP® – just use an operating tool.

Advantage:

To open the clamp, the operating tool is inserted vertically. The conductor entry is less than 15 degrees for easier wiring.

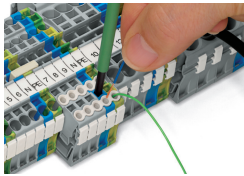

Conductor termination – insulation stop

Commoning

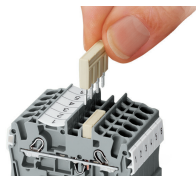

Insert push-in type jumper bar and push down until it hits backstop.

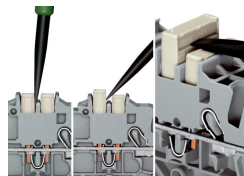

Removing a push-in type jumper bar:

Insert the operating tool between the jumper and partition wall of the dual jumper slots, then lift up the jumper. Place the operating tool in the center of jumpers for up to five contacts (see above), or alternately on both sides for jumpers with more than five contacts.

Commoning

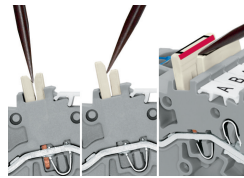
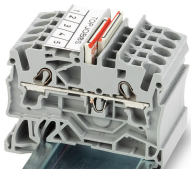

Orient the staggered jumpers' red stripes on the inside. Insert the staggered jumper and push down until it hits the backstop.

Removing a staggered jumper: Insert the operating tool between the staggered jumpers, then lift up the jumper.

Commoning

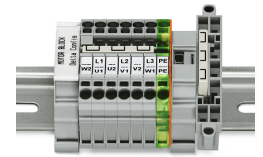
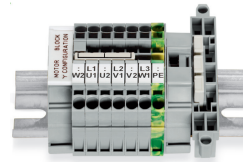
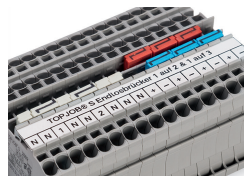

Continuous jumpers (2002 Series) readily connect an endless number of terminal blocks to each other via single jumper slot. Use the second jumper slot for additional commoning or testing.

The 1-to-3 adjacent jumper for continuous commoning enables every other terminal block to be commoned. For example, positive and negative potentials can be accommodated alongside each other.

This star point jumper has been specially developed to create a "star point" and is used on motor terminal boards equipped with Rail-Mount Terminal Blocks TOPJOB® S.

This delta jumper has been specially developed to create a delta configuration and is used on motor terminal boards equipped with rail-mount terminal blocks TOPJOB® S.

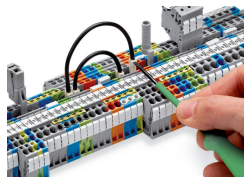

Push down the wire jumper until fully inserted. Lift the jumper with an operating tool for rewiring.

Commoning

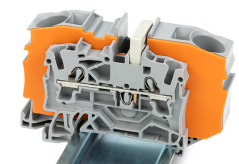
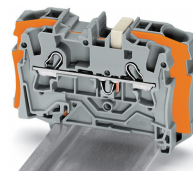
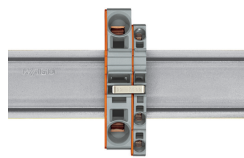
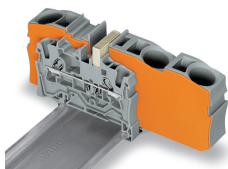

Step-down jumpers common terminal blocks of different sizes, without losing a conductor clamping point. This can be beneficial on long conductor runs where voltage drop can be a problem. A large conductor can be easily connected to smaller conductors at the distribution point. Commoning may be made in either direction using the special thin end plate to cover the open side. Additional through terminal blocks having a smaller cross-section may be commoned using push-in type jumper bars.

Using step-down jumpers, an end plate must be inserted between the terminal blocks to be commoned.

Step-down jumper (Item No. 2006-499) commons 6/4 mm² (10/12 AWG) terminal blocks (2006/2004 Series) with 4/2.5/1.5 mm² (AWG 12/14/16) terminal blocks (2004/2002/2001 Series).

Step-down jumper (Item No. 2016-499) commons 16/10 mm² (16/8 AWG) terminal blocks (2016/2010 Series) with 10/6/4/2.5 mm² (8/10/12/14 AWG) terminal blocks (2010/2006/2004/2002 Series).

Commoning

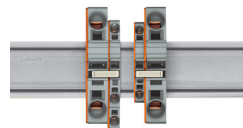
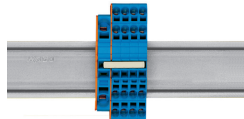
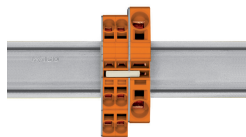

Stepping down via push-in type jumper bar:
Commoning via open terminal side with end plate allows jumpering over two cross-section sizes for 16 mm² (6 AWG) and 10 mm² (8 AWG) and one cross-section size for 6/4/2.5 mm² (10/12/14 AWG). An example: from 16 mm² (6 AWG) to 6 mm² (10 AWG) (see illustration above) or from 10 mm² (8 AWG) to 4 mm² (12 AWG).

Stepping down via push-in type jumper bar:
Commoning via closed terminal side with end plate allows jumpering over two cross-section sizes, e.g., from 16 mm² (6 AWG) to 6 mm² (10 AWG) or from 6 mm² (10 AWG) to 2.5 mm² (14 AWG) (see illustration above).

Note:
The total current of the outgoing circuits must not exceed the nominal current of the step-down jumper/push-in type jumper bar.

Testing

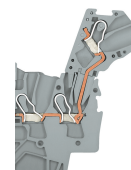
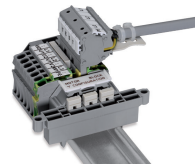
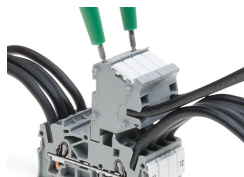
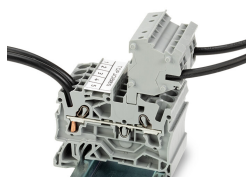

The modular TOPJOB® S connectors also connect conductors of the same size as the terminal blocks being used.

TOPJOB® S Connectors with a 2 mm Ø test socket for testing voltage via 2-pole voltage tester

Rail-mount terminal block assembly for electric motor wiring

L-type test plug module – cross-sectional view of contacts



Test plug adapter (2009-174, CAT I) for 4 mm Ø plugs – compatible with 2000 to 2016 Series

Testing tap (2009-182) for tool-free connection of test cables up to 2.5 mm² (12 AWG) – compatible with 2000 to 2016 Series

Marking

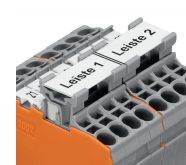
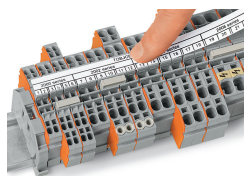
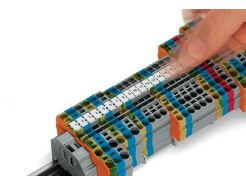

Snapping WMB Inline markers into marker slots.

TOPJOB® S 2009-193 Group Marker Carrier (equipped with a marking strip) for all 2001 to 2016 Series TOPJOB® S Rail-Mount Terminal Blocks
Do not use on an end plate!

Using marker carriers for marking strips (2002-161) in jumper slots.

Ex application

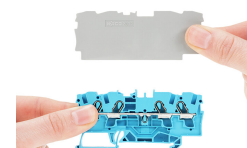
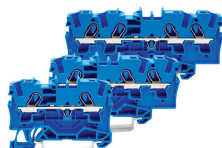
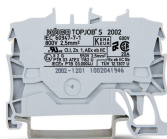

Through terminal blocks with a blue insulated housing are suitable for Ex i applications.

All through and ground conductor terminal blocks are suitable for Ex e II applications.

Separator plate for Ex e/Ex i applications
An end plate must be applied to the terminal block located directly behind an Ex e/Ex i separator plate.

Ex application

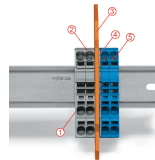
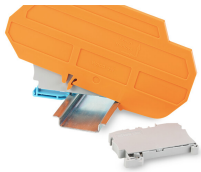

Ex e II/Ex i terminal strip

Note:

The movable feet of terminal blocks and separator plates must face the same direction.

A separator plate is located between the Ex e II and Ex i terminal strip.

End plate

Ex e II terminal blocks

Separator plate for Ex e/Ex i applications

End plate

Ex i terminal blocks

According to EN 50020, a minimum distance of 50 mm must be kept between live parts of Ex e and Ex i circuits. The use of Ex e/Ex i separators is a space-saving solution when Ex e and Ex i terminal blocks are mounted on a common DIN-rail.