

# PC 4/ 3-STF-7,62 RAE - PCB connector



1859933

<https://www.phoenixcontact.com/us/products/1859933>

Please be informed that the data shown in this PDF document is generated from our online catalog. Please find the complete data in the user documentation. Our general terms of use for downloads are valid.



PCB connector, nominal cross section: 4 mm<sup>2</sup>, color: green, nominal current: 20 A, rated voltage (III/2): 630 V, contact surface: Tin, contact connection type: Socket, number of potentials: 3, number of rows: 1, number of positions: 3, number of connections: 3, product range: PC 4/..-STF, pitch: 7.62 mm, connection method: Screw connection with tension sleeve, screw head form: L Slotted, conductor/PCB connection direction: 0 °, locking clip: - without locking clip, plug-in system: COMBICON PC 4, locking: Screw locking mechanism, mounting: Screw flange, type of packaging: packed in cardboard

## Your advantages

- Well-known connection principle allows worldwide use
- Low temperature rise, thanks to maximum contact force
- Allows connection of two conductors
- Integrated double steel spring provides additional safety in the event of temperature and power fluctuations
- Flange with knurled screw that does not require tools, for superior mechanical stability

## Commercial data

Item number	1859933
Packing unit	50 pc
Minimum order quantity	50 pc
Sales key	AA08
Product key	AAHGIB
GTIN	4017918265427
Weight per piece (including packing)	21.655 g
Weight per piece (excluding packing)	21.6 g
Customs tariff number	85366990
Country of origin	DE

# PC 4/ 3-STF-7,62 RAE - PCB connector



1859933

<https://www.phoenixcontact.com/us/products/1859933>

## Technical data

### Product properties

Product type	PCB connector
Product family	PC 4/..-STF
Product line	COMBICON Connectors Special
Type	Standard
Number of positions	3
Pitch	7.62 mm
Number of connections	3
Number of rows	1
Number of potentials	3
Mounting flange	yes

### Electrical properties

Nominal current $I_N$	20 A
Nominal voltage $U_N$	630 V
Rated voltage (III/3)	400 V
Rated surge voltage (III/3)	6 kV
Rated voltage (III/2)	630 V
Rated surge voltage (III/2)	6 kV
Rated voltage (II/2)	1000 V
Rated surge voltage (II/2)	6 kV

### Connection data

#### Connection technology

Type	Standard
Connector system	COMBICON PC 4
Nominal cross section	4 mm <sup>2</sup>
Contact connection type	Socket

#### Interlock

Locking type	Screw locking mechanism
Mounting flange	Screw flange

#### Conductor connection

Connection method	Screw connection with tension sleeve
Conductor/PCB connection direction	0 °
Conductor cross section rigid	0.2 mm <sup>2</sup> ... 4 mm <sup>2</sup>
Conductor cross section flexible	0.2 mm <sup>2</sup> ... 4 mm <sup>2</sup>
Conductor cross section AWG	24 ... 10
Conductor cross section flexible, with ferrule without plastic sleeve	0.25 mm <sup>2</sup> ... 4 mm <sup>2</sup>
Conductor cross section, flexible, with ferrule, with plastic sleeve	0.25 mm <sup>2</sup> ... 4 mm <sup>2</sup>

# PC 4/ 3-STF-7,62 RAE - PCB connector



1859933

<https://www.phoenixcontact.com/us/products/1859933>

2 conductors with same cross section, solid	0.2 mm <sup>2</sup> ... 2.5 mm <sup>2</sup>
2 conductors with same cross section, flexible	0.2 mm <sup>2</sup> ... 1.5 mm <sup>2</sup>
2 conductors with same cross section, flexible, with ferrule without plastic sleeve	0.25 mm <sup>2</sup> ... 1.5 mm <sup>2</sup>
2 conductors with the same cross section, flexible, with TWIN ferrule with plastic sleeve	0.5 mm <sup>2</sup> ... 2.5 mm <sup>2</sup>
Stripping length	7 mm
Drive form screw head	Slotted (L)
Tightening torque	0.5 Nm ... 0.6 Nm

## Material specifications

### Material data - contact

Note	WEEE/RoHS-compliant, free of whiskers according to IEC 60068-2-82/JEDEC JESD 201
Contact material	Cu alloy
Surface characteristics	hot-dip tin-plated
Metal surface terminal point (top layer)	Tin (4 - 8 µm Sn)
Metal surface contact area (top layer)	Tin (4 - 8 µm Sn)

### Material data - housing

Color (Housing)	green (6021)
Insulating material	PA
Insulating material group	I
CTI according to IEC 60112	600
Flammability rating according to UL 94	V0
Glow wire flammability index GWFI according to EN 60695-2-12	850
Glow wire ignition temperature GWIT according to EN 60695-2-13	775
Temperature for the ball pressure test according to EN 60695-10-2	125 °C

## Dimensions

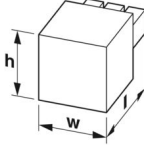
Dimensional drawing	
Pitch	7.62 mm
Width [w]	38.08 mm
Height [h]	18.1 mm
Length [l]	30.7 mm

## Notes

Notes on operation	In accordance with IEC 61984, COMBICON connectors have no switching power (COC). During designated use, they must not be plugged in or disconnected when carrying voltage or under load.
--------------------	--

# PC 4/ 3-STF-7,62 RAE - PCB connector



1859933

<https://www.phoenixcontact.com/us/products/1859933>

## Electrical tests

### Air clearances and creepage distances |

Insulating material group	I
Rated insulation voltage (III/3)	400 V
Rated surge voltage (III/3)	6 kV
Rated insulation voltage (III/2)	630 V
Rated surge voltage (III/2)	6 kV
Rated insulation voltage (II/2)	1000 V
Rated surge voltage (II/2)	6 kV

## Packaging specifications

Type of packaging	packed in cardboard
-------------------	---------------------

# PC 4/ 3-STF-7,62 RAE - PCB connector





1859933

<https://www.phoenixcontact.com/us/products/1859933>

## Approvals

To download certificates, visit the product detail page: <https://www.phoenixcontact.com/us/products/1859933>

 <b>CSA</b> Approval ID: 13631				
	Nominal voltage $U_N$	Nominal current $I_N$	Cross section AWG	Cross section $\text{mm}^2$
Use group B	300 V	20 A	28 - 10	-
Use group C	300 V	20 A	28 - 10	-

 <b>cULus Recognized</b> Approval ID: E60425-19920722				
	Nominal voltage $U_N$	Nominal current $I_N$	Cross section AWG	Cross section $\text{mm}^2$
Use group B	300 V	30 A	30 - 10	-
Use group C	300 V	30 A	30 - 10	-
Use group D	600 V	5 A	30 - 10	-

 <b>DNV GL</b> Approval ID: TAE00001EZ				
--	--	--	--	--

 <b>LR</b> Approval ID: LR21308805TA				
--	--	--	--	--

 <b>BV</b> Approval ID: 35433/B0 BV				
---	--	--	--	--

# PC 4/ 3-STF-7,62 RAE - PCB connector



1859933

<https://www.phoenixcontact.com/us/products/1859933>

## Classifications

### ECLASS

ECLASS-11.0	27460202
ECLASS-12.0	27460202
ECLASS-13.0	27460202

### ETIM

ETIM 8.0	EC002638
----------	----------

### UNSPSC

UNSPSC 21.0	39121400
-------------	----------

# PC 4/ 3-STF-7,62 RAE - PCB connector



1859933

<https://www.phoenixcontact.com/us/products/1859933>

## Environmental product compliance

### EU RoHS

Fulfills EU RoHS substance requirements	Yes, No exemptions
---	--------------------

### China RoHS

Environment friendly use period (EFUP)	EFUP-E
	No hazardous substances above the limits

### EU REACH SVHC

REACH candidate substance (CAS No.)	No substance above 0.1 wt%
-------------------------------------	----------------------------

# PC 4/ 3-STF-7,62 RAE - PCB connector



1859933

<https://www.phoenixcontact.com/us/products/1859933>

## Accessories

### CP-PC RD - Coding profile

1701967

<https://www.phoenixcontact.com/us/products/1701967>

Coding profile, for plugging into the coding ribs of the plug at a later date, insulating material, color: Red



---

### SK 7,62/3,8:FORTL.ZAHLEN - Marker card

0804549

<https://www.phoenixcontact.com/us/products/0804549>

Marker card, white, labeled, horizontal: consecutive numbers 1 ... 10, 11 ... 20, etc. up to 91 ... 100, mounting type: adhesive, for terminal block width: 7.62 mm, lettering field size: 7.62 x 3.8 mm

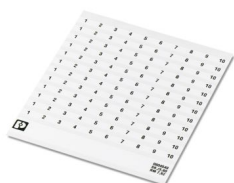

## PC 4/ 3-STF-7,62 RAE - PCB connector

1859933

<https://www.phoenixcontact.com/us/products/1859933>



## SZS 0,6X3,5 - Screwdriver

1205053

<https://www.phoenixcontact.com/us/products/1205053>



Actuation tool, for ST terminal blocks, insulated, also suitable for use as a bladed screwdriver, size: 0.6 x 3.5 x 100 mm, 2-component grip, with non-slip grip

---

## SK 3,8 REEL P7,62 WH CUS - Marker card

0825128

<https://www.phoenixcontact.com/us/products/0825128>



Marker card, can be ordered: by card, white, labeled according to customer specifications, mounting type: adhesive, for terminal block width: 7.62 mm, lettering field size: continuous x 3.8 mm

# PC 4/ 3-STF-7,62 RAE - PCB connector

1859933

<https://www.phoenixcontact.com/us/products/1859933>



## SK U/3,8 WH:UNBEDRUCKT - Marker card

0803906

<https://www.phoenixcontact.com/us/products/0803906>

Marker card, Din A4, white, unlabeled, can be labeled with: PLOTMARK, CMS-P1-PLOTTER, Office printing systems, mounting type: adhesive, for terminal block width: 210 mm, lettering field size: 186 x 3.8 mm, Number of individual labels: 1440



---

Phoenix Contact 2024 © - all rights reserved

<https://www.phoenixcontact.com>

Phoenix Contact USA  
586 Fulling Mill Road  
Middletown, PA 17057, United States  
(+717) 944-1300  
[info@phoenixcon.com](mailto:info@phoenixcon.com)