

1600 Series

Sumicon 1600 Series



Wide Variation



Positive-Lock



May.1.2026 Copyright 2026 HIROSE ELECTRIC CO., LTD. All Rights Reserved.



Product Page
<https://www.hirose.com/en/product/series/1600>

May 2024

Overview

The Sumicon 1600 series from Hirose includes a versatile range of multi-contact rectangular connectors, available in models with 8, 12, 16, 20, 24, 28, 34, 45, and 60 positions. These connectors come in both soldering and crimping types. Accessories such as the C case, CA case, ST stopper, and STA stopper are also available. By combining these accessories, the Sumicon 1600 series can be adapted to a wide variety of applications.

Features

The Sumicon 1600 series has separated connector units and accessories (cases and stoppers) allow for versatile combinations and simplifying cable assembly.

Product Specifications

Rated Current	3A
Rated Voltage	300V AC / 420V DC

Operating Temperature	-55 to +85°C
Contact Resistance	7 mΩ Max. at 1A DC
Insulation Resistance	1000M Ω Min. at 500V DC
Withstanding Voltage	1000V AC for 1 min.

Materials / Finish

Part	Materials	Color / Finish	RoHS2
Insulator	Glass Filled Diallyphthalate Resin	Blue	Yes
Male Contact	Brass	A type : Silver Plated	
Female Contact	Phosphor Bronze		
Plug Case	ABS Resin (Black)	NTT spec : ABS Resin 2.5PB 6.0/2.0 (color)	
Stopper Bracket	Steel	Nickel Plating	

Product Number Structure

Refer to the chart below when determining the product specifications from the product number.
Please select from the product numbers listed in this catalog when placing orders.

P - **16 34** # **A - C** # ()

① ② ③ ④ ⑤ ⑥ ⑦ ⑧ ⑨

① Contact Gender	P : Male Contact S : Female Contact	⑦ Category Symbol for Accessories	C : Plug Case ST : Stopper Bracket
② Termination Style	None : Solder Type	⑧ Serial Symbol for Accessories by Type	Each accessory (C, ST, J, H, DB) is provided with sequence of upper-case, alphabetic characters. Sequence : No sign, A, B, C Accessories, C, ST, or J followed by No sign : Side lock type Accessories, C and ST followed by A : Top touch lock type Note : The space for no sign is filled sequentially.
③ Series Name	16 : 1600 Series		
④ No. of Pos.	8, 12, 16, 20, 24, 28, 34, 45, 60		
⑤ Serial Symbol by Connector Unit Type	Alphabets (capital letters) are sequentially assigned and divided according to the type. However, in the order of no symbol, B, C, D, E	⑨ Specifications	In the case of a special Specifications, it is given by a later number in ().
⑥ Contact Plating Type	A : Silver Plated		

Functional Diagram

■ When using a Cover Case

Side Lock Type

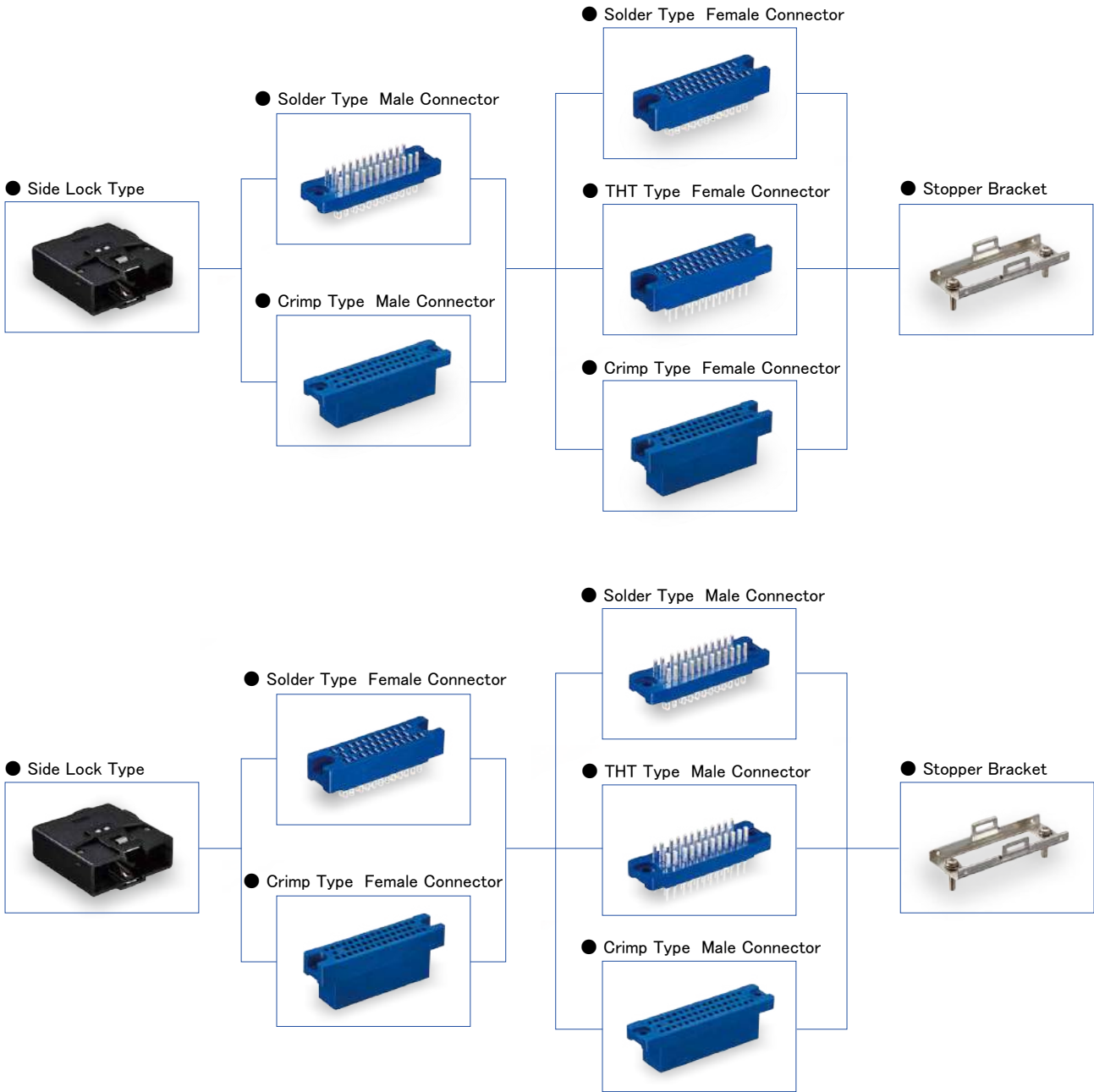

May. 1. 2026 Copyright 2026 HIROSE ELECTRIC CO., LTD. All Rights Reserved.

Top Touch Lock Type

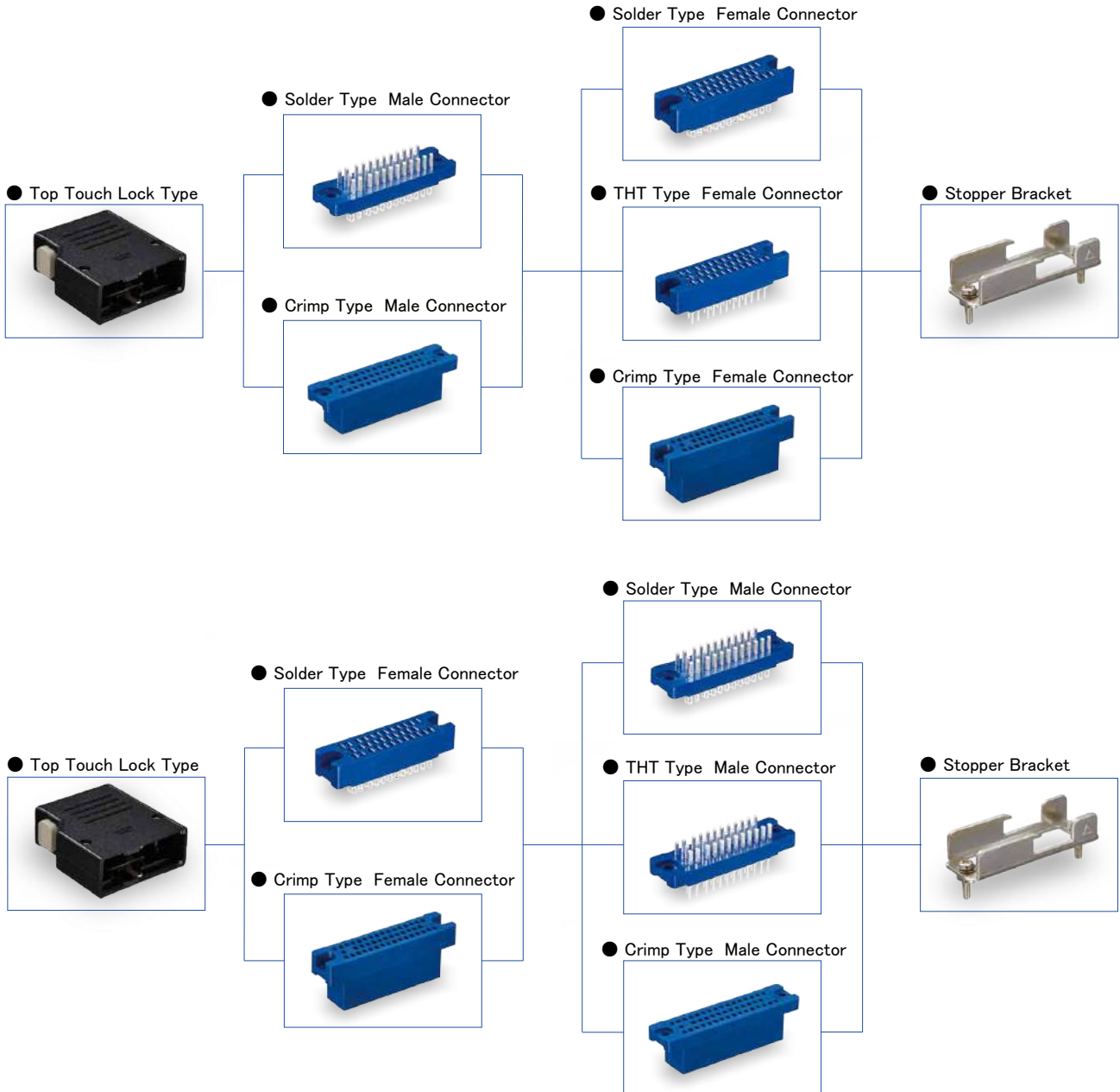

■ When using a Plastic Lock

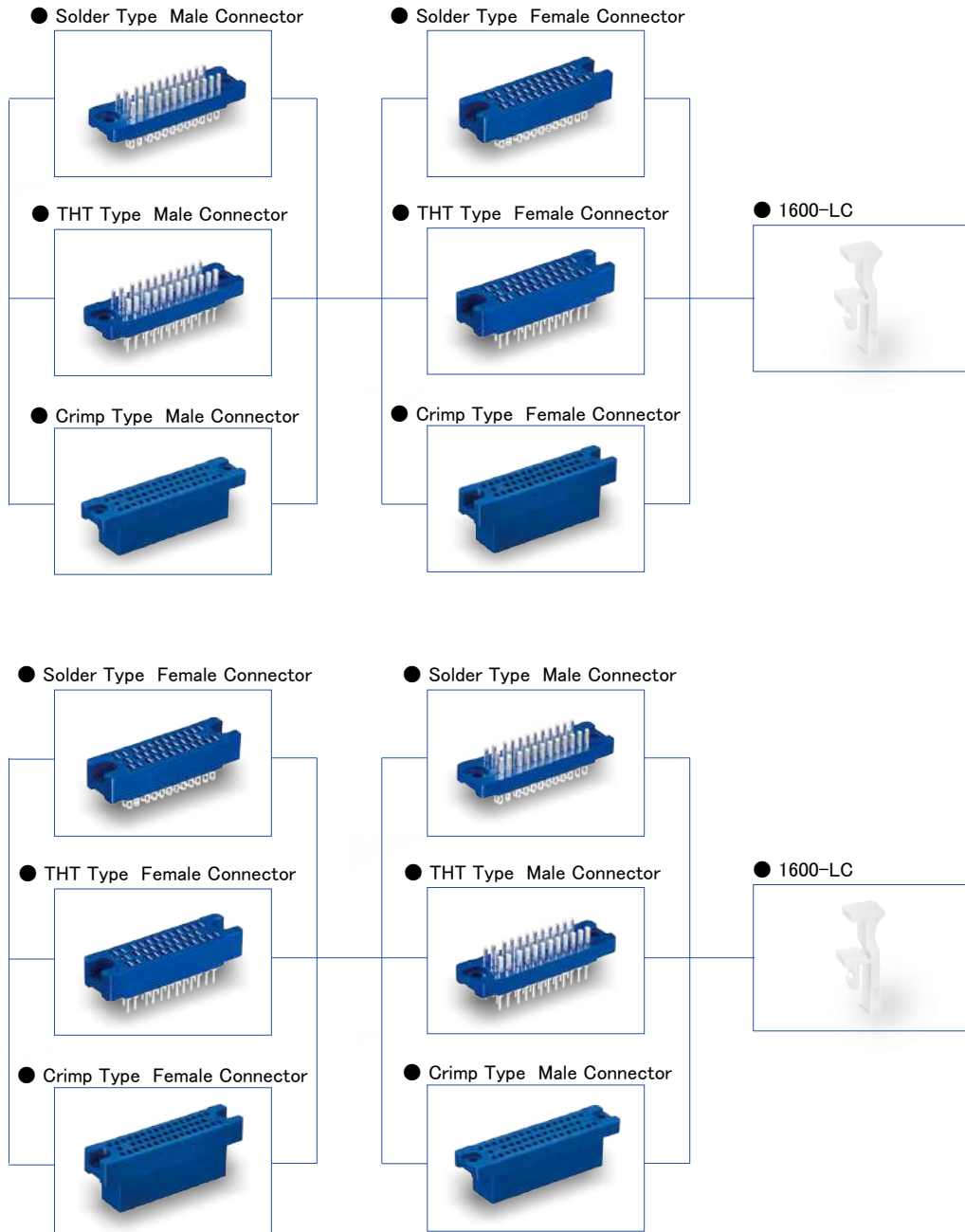

■ Crimp Case Combination

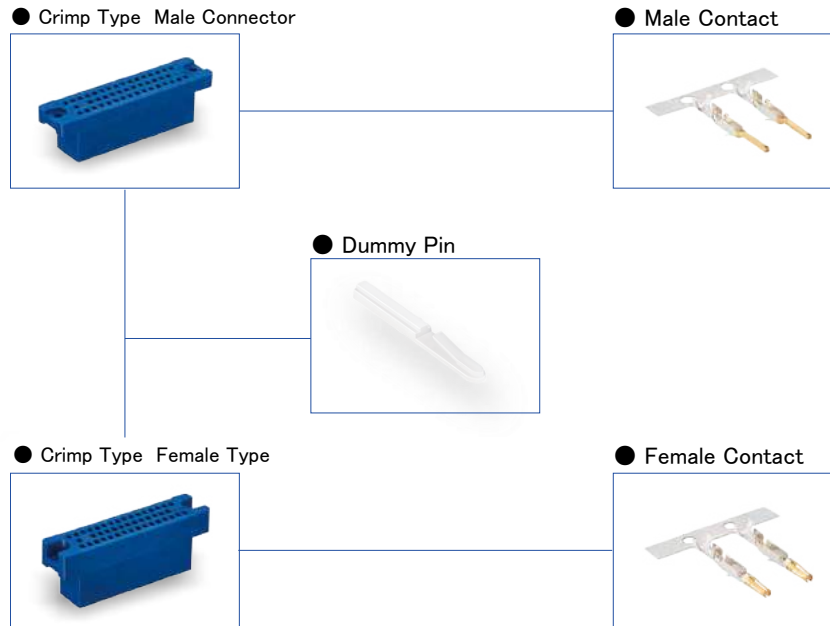

Soldering Type Connector Unit

● Male Connector

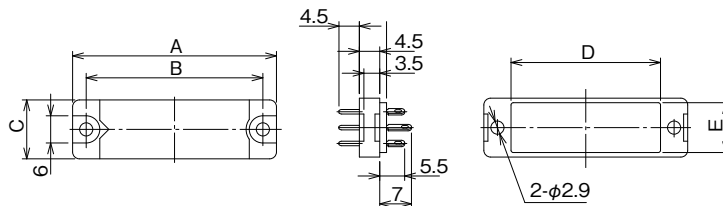

P-1634BA(09)

Unit : mm

A Type		No. of Pos.	A	B	C	D	E
Part No.	HRS No.						
P-1608BA(09) (Note)	CL0216-0171-5-09	8	25	19	10	13	8
P-1612BA(09) (Note)	CL0216-0172-8-09	12	30	24		18	
P-1616BA(09) (Note)	CL0216-0173-0-09	16	35	29		23	
P-1620BA(09) (Note)	CL0216-0174-3-09	20	33	27	13	21	11
P-1624BA(09) (Note)	CL0216-0175-6-09	24	37	31		25	
P-1628BA(09) (Note)	CL0216-0176-9-09	28	40	34		28	
P-1634BA(09) (Note)	CL0216-0177-1-09	34	45	39		33	
P-1645BA(10) (Note)	CL0216-0178-4-10	45	54	48		42	
P-1660BA(10) (Note)	CL0216-0179-7-10	60	67	61		55	

Note : Standard Product

● Female Connector

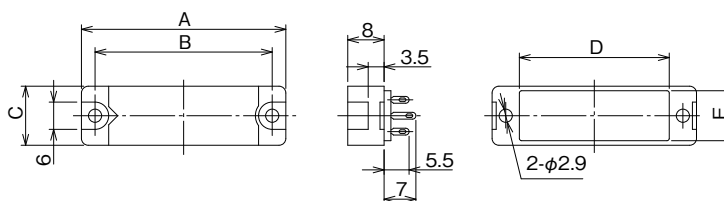

S-1634A(09)

Unit : mm

A Type		No. of Pos.	A	B	C	D	E
Part No.	HRS No.						
S-1608A(09) (Note)	CL0216-0001-5-09	8	25	19	10	13	8
S-1612A(09) (Note)	CL0216-0002-8-09	12	30	24		18	
S-1616A(09) (Note)	CL0216-0003-0-09	16	35	29		23	
S-1620A(09) (Note)	CL0216-0004-3-09	20	33	27	13	21	11
S-1624A(09) (Note)	CL0216-0005-6-09	24	37	31		25	
S-1628A(09) (Note)	CL0216-0006-9-09	28	40	34		28	
S-1634A(09) (Note)	CL0216-0007-1-09	34	45	39		33	
S-1645A(10) (Note)	CL0216-0008-4-10	45	54	48		42	
S-1660A(10) (Note)	CL0216-0009-7-10	60	67	61		55	

Note : Standard Product

Side Lock Type Plug Case

All these products are plug cases only. Please order connector units separately. The cases can be used for both male and female connector units.



P-1634A-C(50)

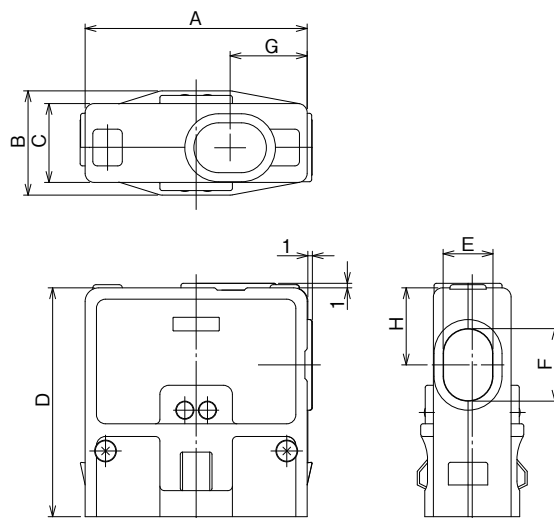

Unit : mm

Part No.	HRS No.	No. of Pos.	A	B	C	D	E	F	G	H
P-1608A-C(50) (Note)	CL0216-0028-1-50	8	29	20	14.5	42	7.5	7.5	12.5	12.5
P-1612A-C(50) (Note)	CL0216-0029-4-50	12	34			43.5		9	13.5	13.5
P-1616A-C(50) (Note)	CL0216-0030-3-50	16	39			46		11.5	14.5	14.5
P-1620A-C(50) (Note)	CL0216-0031-6-50	20	37	23	17.5	45.5	11	11	15	15
P-1624A-C(50) (Note)	CL0216-0032-9-50	24	41			46.5		12		
P-1628A-C(50) (Note)	CL0216-0033-1-50	28	44			47.5		13	15.5	15.5
P-1634A-C(50) (Note)	CL0216-0034-4-50	34	49			50.5		15	17	17
P-1645A-C(50) (Note)	CL0216-0035-7-50	45	58			18.5		54.5	19	18.5
P-1660A-C(50) (Note)	CL0216-0036-0-50	60	71	59.5	24		21	22		

Note : Standard Product

Side Lock Type Stopper Bracket

All these products are stopper brackets only. Please order connector units separately. The cases can be used for both male and female connector units.

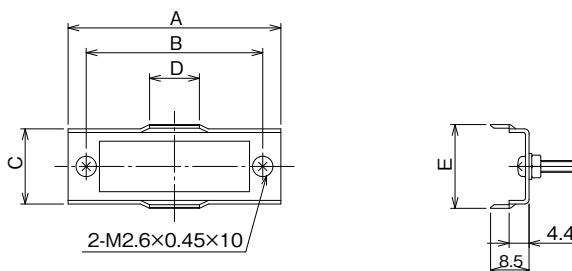

P-1634A-ST(51)

Unit : mm

Part No.	HRS No.	No. of Pos.	A	B	C	D	E
P-1608A-ST(51) (Note)	CL0216-0046-3-51	8	27	19	13.6	9.2	15.5
P-1612A-ST(51) (Note)	CL0216-0047-6-51	12	32	24		11.0	
P-1616A-ST(51) (Note)	CL0216-0048-9-51	16	37	29			
P-1620A-ST(51) (Note)	CL0216-0049-1-51	20	35	27			
P-1624A-ST(51) (Note)	CL0216-0050-0-51	24	39	31	16.6		15.0
P-1628A-ST(51) (Note)	CL0216-0051-3-51	28	42	34			
P-1634A-ST(51) (Note)	CL0216-0052-6-51	34	47	39	16.6	15.0	
P-1645A-ST(51) (Note)	CL0216-0053-9-51	45	56	48			
P-1660A-ST(51) (Note)	CL0216-0054-1-51	60	69	61			

Note : Standard Product

Top Touch Lock Type Plug Case

All these products are plug cases only. Please order connector units separately. The cases can be used for both male and female connector units.



P-1634A-CA(50)

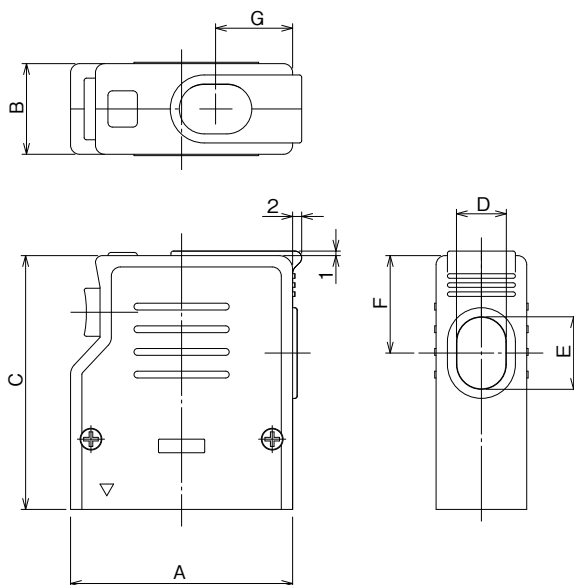

Unit : mm

Part No.	HRS No.	No. of Pos.	A	B	C	D	E	F	G
P-1620A-CA(50) (Note)	CL0216-0149-6-50	20	37	20	51	11	11	18	14.5
P-1624A-CA(50) (Note)	CL0216-0147-0-50	24	41		51		12	18.5	15
P-1628A-CA(50) (Note)	CL0216-0150-5-50	28	44		53		13	20	15.5
P-1634A-CA(50) (Note)	CL0216-0111-3-50	34	49		56		16	21.5	17
P-1645A-CA(50) (Note)	CL0216-0112-6-50	45	58		60		19	24	18.5
P-1660A-CA(50) (Note)	CL0216-0113-9-50	60	71		65		24	26.5	21

Note : Standard Product

Top Touch Lock Type Stopper Bracket

All these products are stopper brackets only. Please order connector units separately. The cases can be used for both male and female connector units.

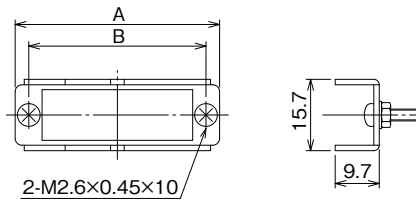

P-1634A-STA(51)

Unit : mm

Part No.	HRS No.	No. of Pos.	A	B
P-1620A-STA(51) (Note)	CL0216-0156-1-51	20	33	27
P-1624A-STA(51) (Note)	CL0216-0157-4-51	24	37	31
P-1628A-STA(51) (Note)	CL0216-0158-7-51	28	40	34
P-1634A-STA(51) (Note)	CL0216-0123-2-51	34	45	39
P-1645A-STA(51) (Note)	CL0216-0124-5-51	45	54	48
P-1660A-STA(51) (Note)	CL0216-0125-8-51	60	67	61

Note : Standard Product

While Taking into Consideration

Specifications mentioned in this catalog are reference values.

When considering to order or use this product, please review the Drawing and Product Specifications sheets.

Use an appropriate cable when using the connector in combination with cables.

If considering usage of a non- specified cable, please contact your sales representative.

If assembly process is done by jigs & tools which are not identified by Hirose, the warranty of the product may be affected.

If considering usage for below mentioned applications, please contact your sales representative.

In cases where the application will demand a high level of reliability, such as automotive, medical instruments, public infrastructure, aerospace/ defense etc. Hirose must review before assurance of reliability can be given.

HIROSE**HIROSE ELECTRIC CO.,LTD.**2-6-3, Nakagawa Chuoh, Tsuzuki-Ku, Yokohama-Shi 224-8540, JAPAN
<https://www.hirose.com>

※ The contents of this catalog are current as of date of 5/2024. Contents are subject to change without notice for the purpose of improvements.
※ The HRS logo and "HIROSE" are trademarks of HIROSE ELECTRIC CO., LTD.

1600 Series

Sumicon 1600 Series Crimp Type



Wide Variation



Positive-Lock



May.1.2026 Copyright 2026 HIROSE ELECTRIC CO., LTD. All Rights Reserved.



Product Page
<https://www.hirose.com/en/product/series/1600>

May 2024

Overview

The Sumicon 1600 series is a high-performance, compact crimp connector designed to save labor in cable assembly operations.

It offers a wide range of position variations (8, 12, 16, 20, 24, 28, 34, 45, and 60 positions) just like its predecessors, ensuring full compatibility with the plug cases.

This series also features an easy-to-install plastic lock, even for single-unit use, with expanded functionality.

Features

The Sumicon 1600 series has separated connector units and accessories (cases and stoppers) allow for versatile combinations and simplifying cable assembly.

1. Crimping termination method ensures highly reliable connections.
2. Dual (two-point) contacts provide enhanced reliability.
3. Compatible with THT and soldering types for a wide range of applications.
4. Choose from top touch lock or side lock based on application needs.

Product Specifications

Rated Current	3A
Rated Voltage	300V AC / 420V DC

Operating Temperature	-55 ~ +85°C			
Contact Resistance	7m Ω Max. at 1A DC (Only contact)			
Insulation Resistance	5,000M Ω Min. at 500V DC			
Withstanding Voltage	1,000V AC for 1min			
Applicable Cable	24-28 AWG (Jacket Diameter: ϕ 0.9-1.6)			
Crimp Strength (Unit: More than kg)	AWG	24 AWG	26 AWG	28 AWG
	Crimp Strength	3.6	2.4	1.6

Materials / Finish

Parts	Material	Color/Finish	RoHS2
Insulator	Glass-filled Polycarbonate Resin UL94V-0	Blue	○
Male Contact	Brass	Gold Plated Silver Plated	
Female Contact	Phosphor Bronze	Gold Plated Silver Plated	

Product Number Structure

Refer to the chart below when determining the product specifications from the product number.
Please select from the product numbers listed in this catalog when placing orders.

Housing

C - 16

① ② ③ ④

Contact

C - 1600 - # #

① ② ③ ⑤ ⑥ ⑦

① Contact Gender	P : Male Contact S : Female Contact	⑤ Contact Type	1 : Loose Contact 2 : Reel Contacts
② Termination Style	C : Crimp Type	⑥ Aplicable Cable	1 : 24-28 AWG
③ Series Name	16 : 1600 Series	⑦ Contact Plating Type	1 : Gold Plated 2 : Silver Plated
④ No. of Pos.	8, 12, 16, 20, 24, 28, 34, 45, 60		

Housing

● Male Connector

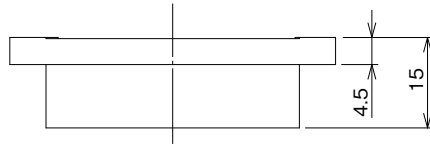
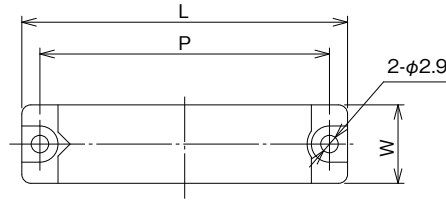

Unit : mm

Part No	HRS No.	No of Pos,	L	P	W
PC-1608(10) (Note)	CL0216-0335-0-10	8	25	19	10
PC-1612(10) (Note)	CL0216-0336-3-10	12	30	24	
PC-1616(10) (Note)	CL0216-0337-6-10	16	35	29	
PC-1620(10) (Note)	CL0216-0338-9-10	20	33	27	13
PC-1624(10) (Note)	CL0216-0339-1-10	24	37	31	
PC-1628(10) (Note)	CL0216-0340-0-10	28	40	34	
PC-1634(10) (Note)	CL0216-0341-3-10	34	45	39	
PC-1645(10) (Note)	CL0216-0342-6-10	45	54	48	
PC-1660(10) (Note)	CL0216-0343-9-10	60	67	61	

Note: Standard Product

● Female Connector

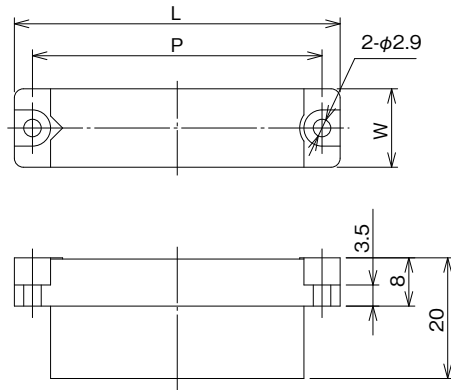

Unit : mm

Part No	HRS No.	No. of Pos.	L	P	W
SC-1608(10) (Note)	CL0216-0344-1-10	8	25	19	10
SC-1612(10) (Note)	CL0216-0345-4-10	12	30	24	
SC-1616(10) (Note)	CL0216-0346-7-10	16	35	29	
SC-1620(10) (Note)	CL0216-0347-0-10	20	33	27	13
SC-1624(10) (Note)	CL0216-0348-2-10	24	37	31	
SC-1628(10) (Note)	CL0216-0349-5-10	28	40	34	
SC-1634(10) (Note)	CL0216-0350-4-10	34	45	39	
SC-1645(10) (Note)	CL0216-0351-7-10	45	54	48	
SC-1660(10) (Note)	CL0216-0352-0-10	60	67	61	

Note: Standard Product

Contact

● Male Contact

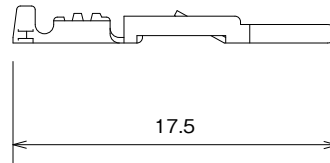

PC-1600-211

Unit : mm

Type	Part No.	HRS No.	Plating	Purchase Unit
Loose Contact	PC-1600-111 (Note)	CL0216-0331-0-00	Gold	100pcs per bag
	PC-1600-112 (Note)	CL0216-0332-2-00	Silver	
Reel Contact	PC-1600-211	CL0216-0363-6-00	Gold	10,000pcs per reel
	PC-1600-212 (Note)	CL0216-0364-9-00	Silver	

Note: Standard Product

● Female Contact

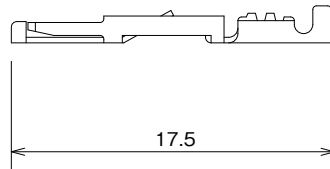

SC-1600-211

Unit : mm

Type	Part No.	HRS No.	Plating	Purchase Unit
Loose Contact	SC-1600-111 (Note)	CL0216-0333-5-00	Gold	100pcs per bag
	SC-1600-112 (Note)	CL0216-0334-8-00	Silver	
Reel Contact	SC-1600-211	CL0216-0365-1-00	Gold	10,000pcs per reel
	SC-1600-212 (Note)	CL0216-0366-4-00	Silver	

Note: Standard Product

Accessories

Plastic Lock

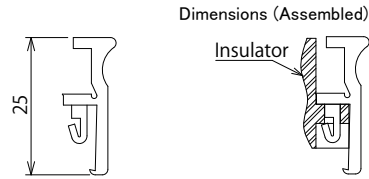

Part No.	HRS No.
1600-LC (Note 2)	CL0216-0354-5-00

Note 1: Can be used with other connector unit (solder, crimp type etc..).
 Note 2: Standard Product

Dummy Pin

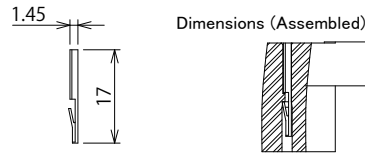

Part No.	HRS No.
SC-1600-KY (Note)	CL0216-0499-0-00

Note: Standard Product

Panel Cut-Out Dimensions

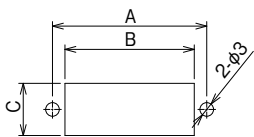

No. of Pos.	A	B	C	Applicable Screw
8	19	13.5	8.5	M2.6
12	24	18.5		
16	29	23.5		
20	27	21.5	11.5	
24	31	25.5		
28	34	28.5		
34	39	33.5		
45	48	42.5		
60	61	55.5		

Contact Arrangement and Contact No.

The figure shows the case when viewed from the connection side of the male connector.

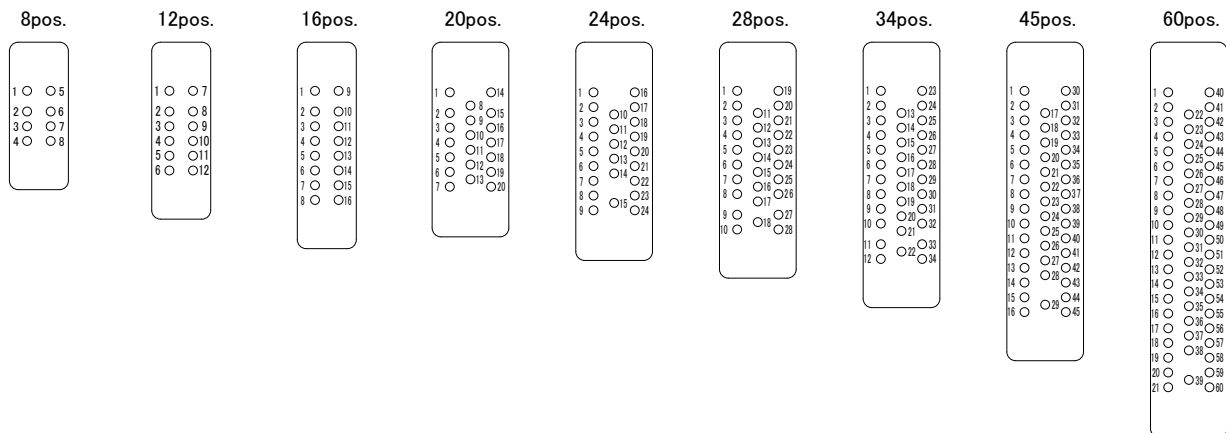

Applicable Tool



Hand Tool TC-1600-111



Contact Extraction Tool TC-1600-21

● Hand Tool

Type	Part No.	HRS No.
Hand Tool	TC-1600-111	CL0250-0003-1-00
Contact Extraction Tool	TC-1600-21	CL0250-0004-4-00

● Auto Crimping Machine

Type	Part No.	HRS No.
Main Unit	CM-105C	CL0901-0001-0-00
Applicator	AP105-1600	CL0901-2505-8-00

Connector Procedures

- (1) When disconnecting, hold the housing instead of the cable.
- (2) When disconnecting, pull straight to avoid damaging the male pins.
- (3) The plastic lock provides sufficient strength against vibration and wire weight but not against other loads. For applications requiring extra strength, use the top touch lock type plug case.
- (4) In harsh environments, use gold plated contacts; for general conditions, silver plated contacts are sufficient.
- (5) Use hand tools for minor crimping and maintenance; use automatic crimp machines for large-scale crimping.
- (6) For plug-in applications, the Sumicon 1600 Series solder type is recommended for optimal functionality.

While Taking into Consideration

Specifications mentioned in this catalog are reference values.

When considering to order or use this product, please review the Drawing and Product Specifications sheets.

Use an appropriate cable when using the connector in combination with cables.

If considering usage of a non-specified cable, please contact your sales representative.

If assembly process is done by jigs & tools which are not identified by Hirose, the warranty of the product may be affected.

If considering usage for below mentioned applications, please contact your sales representative.

In cases where the application will demand a high level of reliability, such as automotive, medical instruments, public infrastructure, aerospace/defense etc. Hirose must review before assurance of reliability can be given.

1600 Series

Sumicon 1600 Series THT Type

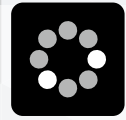

Wide Variation



Positive-Lock

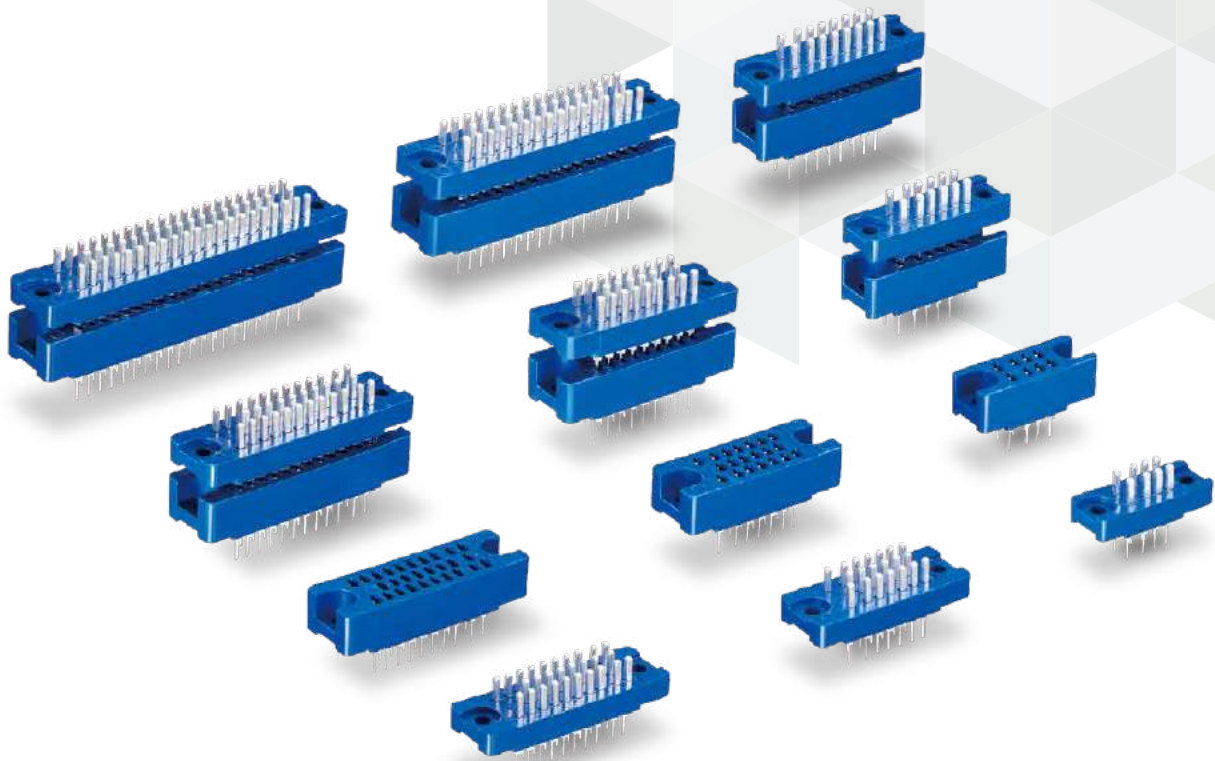

May.1.2026 Copyright 2026 HIROSE ELECTRIC CO., LTD. All Rights Reserved.



Product Page
<https://www.hirose.com/en/product/series/1600>

May 2024

Overview

The Sumicon 1600 series from Hirose includes original rectangular THT connectors available in 8, 12, 16, 20, 24, 28, 34, 45, and 60 position models. Each model is fully compatible with previous 1600 series connectors in terms of mounting and accessories.

Features

The Sumicon 1600 series has separate connector units and accessories (cases and stoppers) providing for versatile combinations and simplifying cable assembly.

1. Supports both board-to-cable and board-to-board connections.
2. Dual (2-point) contacts provide enhanced reliability.
3. Compatible with both crimping and soldering types, suitable for a broad range of applications.

Product Specifications

Rated Current	3A
Rated Voltage	300V AC / 420V DC

Operating Temperature	-55 to +85°C
Contact Resistance	7m Ω Max. at 1A DC
Insulation Resistance	1000M Ω Min. at 500V DC
Withstanding Voltage	1000V AC for 1 min.

Materials / Finish

Part	Materials	Color / Finish	RoHS2
Insulator	Glass-Filled Diallyphtalate Resin	Blue	Yes
Male Contact	Brass	A type : Silver Plated	
Female Contact	Phosphorous Bronze		

Product Number Structure

Refer to the chart below when determining the product specifications from the product number.
Please select from the product numbers listed in this catalog when placing orders.

P D - 16 34 # A - SP # (09)

① ② ③ ④ ⑤ ⑥ ⑦ ⑧ ⑨

① Contact Gender	P : Male Contact S : Female Contact	⑥ Contact Plating Type	A : Silver Plated
② Termination Style	D : THT Type	⑦ Category Symbol for Accessories	SP : Spacer for THT connector
③ Series Name	16 : 1600 Series	⑧ Serial Symbol for Accessories by Type	Alphabets (capital letters) are sequentially assigned and divided according to the type. However, in the order of A, B, ………
④ No. of Pos.	8, 12, 16, 20, 24, 28, 34, 45, 60		
⑤ Serial Symbol by Connector Unit Type	Alphabets (capital letters) are sequentially assigned and divided according to the type. However, in the order of no symbol, B, C, D, E ………	⑨ Specifications	In the case of a special Specifications, it is given by a later number in ().

THT Type Connector Unit

● Male Connector

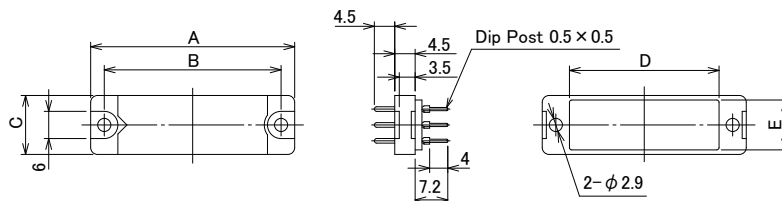

PD-1634BA(09)

Unit : mm

A Type		No. of Pos.	A	B	C	D	E
Part No.	HRS No.						
PD-1608BA(09) (Note)	CL0216-0388-7-09	8	25	19	10	13	8
PD-1612BA(09) (Note)	CL0216-0389-0-09	12	30	24		18	
PD-1616BA(09) (Note)	CL0216-0390-9-09	16	35	29		23	
PD-1620BA(09) (Note)	CL0216-0391-1-09	20	33	27	13	21	11
PD-1624BA(09) (Note)	CL0216-0392-4-09	24	37	31		25	
PD-1628BA(09) (Note)	CL0216-0393-7-09	28	40	34		28	
PD-1634BA(09) (Note)	CL0216-0394-0-09	34	45	39		33	
PD-1645BA(10) (Note)	CL0216-0395-2-10	45	54	48		42	
PD-1660BA(10) (Note)	CL0216-0396-5-10	60	67	61		55	

Note : Standard Product

● Female Connector

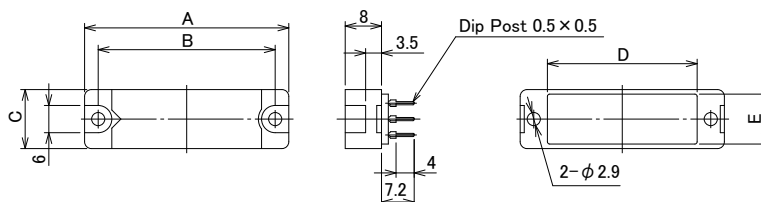

SD-1634A(09)

Unit : mm

A Type		No. of Pos.	A	B	C	D	E
Part No.	HRS No.						
SD-1608A(09) (Note)	CL0216-0379-6-09	8	25	19	10	13	8
SD-1612A(09) (Note)	CL0216-0380-5-09	12	30	24		18	
SD-1616A(09) (Note)	CL0216-0381-8-09	16	35	29		23	
SD-1620A(09) (Note)	CL0216-0382-0-09	20	33	27	13	21	11
SD-1624A(09) (Note)	CL0216-0383-3-09	24	37	31		25	
SD-1628A(09) (Note)	CL0216-0384-6-09	28	40	34		28	
SD-1634A(09) (Note)	CL0216-0385-9-09	34	45	39		33	
SD-1645A(10) (Note)	CL0216-0386-1-10	45	54	48		42	
SD-1660A(10) (Note)	CL0216-0387-4-10	60	67	61		55	

Note : Standard Product

Spacer for THT Connector

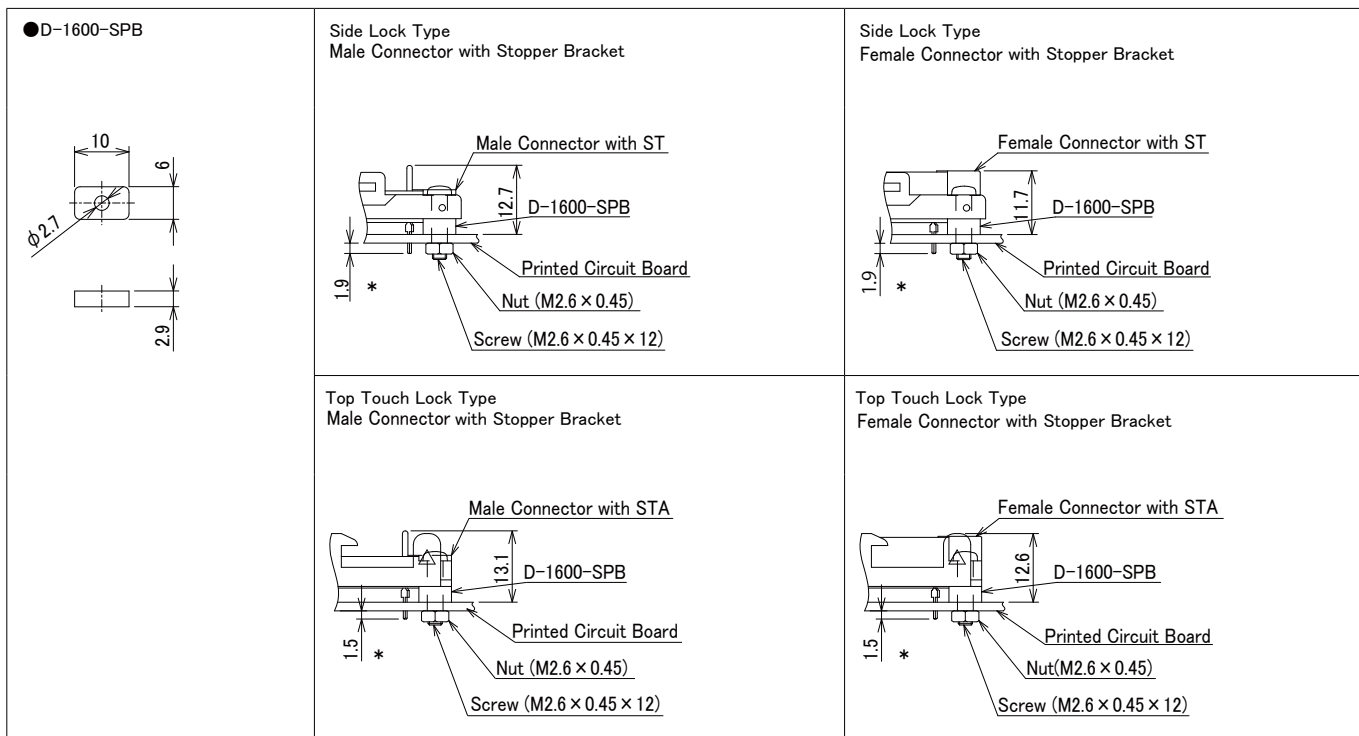
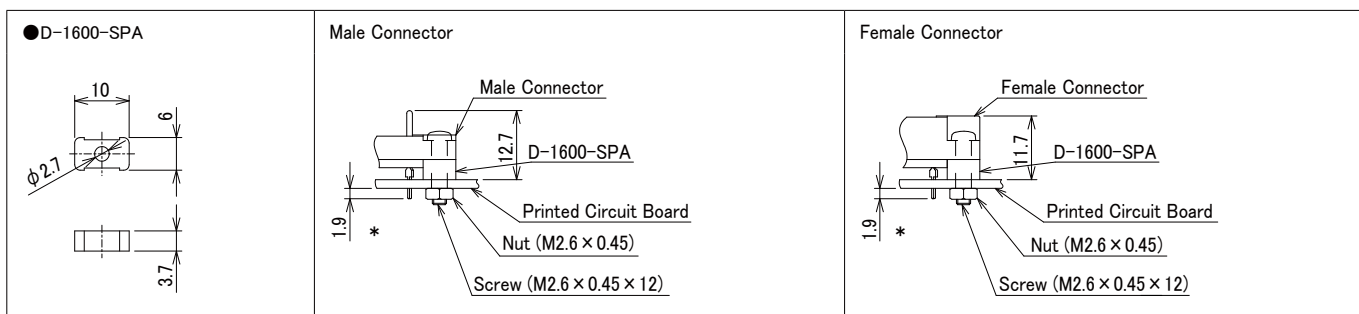

Note 1 : D-1600-SPA is used in combination to mounting a connector unit (Male and female connectors in this catalog) to the board. When the stopper bracket is attached to a connector unit, the board mounting cannot be combined with D-1600-SPA.
 D-1600-SPB is used to mounting the board with the stopper bracket attached to the connector unit. It cannot be used to mounting the board with a connector unit without the stopper bracket attached.

Note 2 : Provide two spacers (SPA and SPB) for each connector unit.
 The dimensions marked with an asterisk (*) are for PCBs of 1.6mm in thickness.

Unit : mm

Part No.	HRS No.	Application
D-1600-SPA (Note 2)	CL0216-0419-9-00	For Connector Unit Mounting (common to each No. of Pos.)
D-1600-SPB (Note 2)	CL0216-0420-8-00	For Connector Unit with Stopper Bracket for Mounting (common to each No. of Pos.)

Note 1 : Please prepare each mounting screw separately.
 Note 2 : Standard Product

Backboard Dimensions

When soldering to a printed circuit board, drill the connector mounting holes as indicated in the diagram. The numbers in the diagram correspond to the contact numbers. The " \triangleleft " symbol marks the V-shape (the orientation) of the connector unit's mating surface.

Backboard Dimensions for Male Connector

(Indicate the view from connector mounting surface of the board)

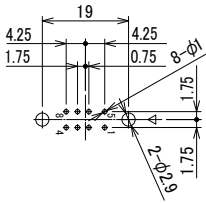

PD-1608BA(09)

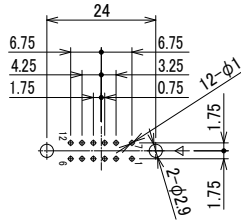

PD-1612BA(09)

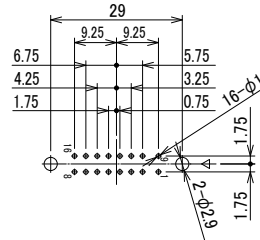

PD-1616BA(09)

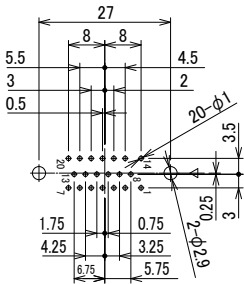

PD-1620BA(09)

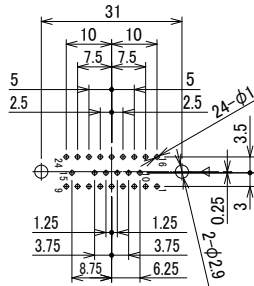

PD-1624BA(09)

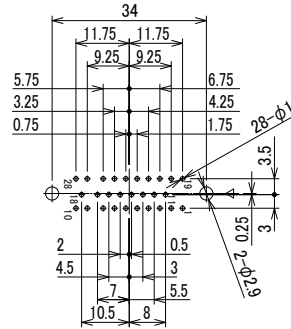

PD-1628BA(09)

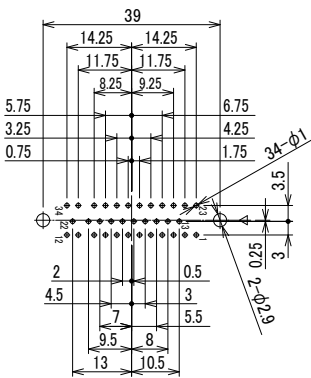

PD-1634BA(09)

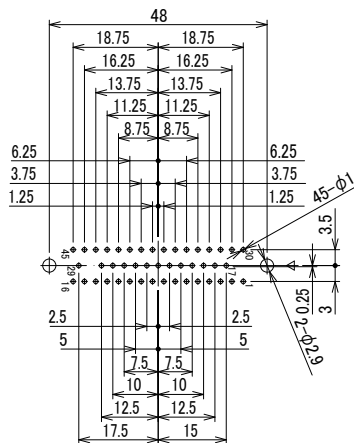

PD-1645BA(10)

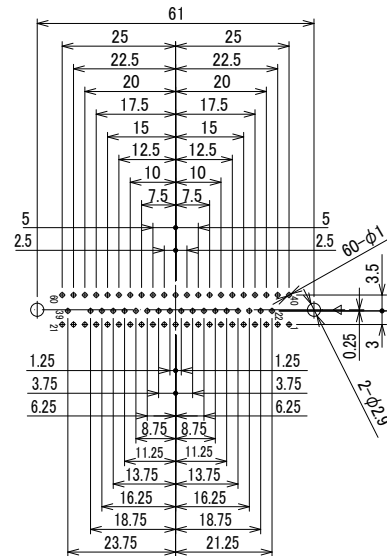

PD-1660BA(10)

■ Panel Cut-Out Dimensions

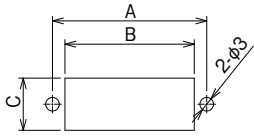

Unit : mm

No. of Pos.	A	B	C	Adaptable Screw
8	19	13.5	8.5	M2.6
12	24	18.5		
16	29	23.5		
20	27	21.5	11.5	
24	31	25.5		
28	34	28.5		
34	39	33.5		
45	48	42.5		
60	61	55.5		

How to use the connector

- (1) When disconnecting, pull straight to avoid damaging the male pins.
- (2) In harsh environments, use gold plated contacts; for general conditions, silver plated contacts are sufficient.

While Taking into Consideration

Specifications mentioned in this catalog are reference values.

When considering to order or use this product, please review the Drawing and Product Specifications sheets.

Use an appropriate cable when using the connector in combination with cables.

If considering usage of a non-specified cable, please contact your sales representative.

If assembly process is done by jigs & tools which are not identified by Hirose, the warranty of the product may be affected.

If considering usage for below mentioned applications, please contact your sales representative.

In cases where the application will demand a high level of reliability, such as automotive, medical instruments, public infrastructure, aerospace/defense etc. Hirose must review before assurance of reliability can be given.

HIROSE**HIROSE ELECTRIC CO.,LTD.**2-6-3, Nakagawa Chuoh, Tsuzuki-Ku, Yokohama-Shi 224-8540, JAPAN
<https://www.hirose.com>

※ The contents of this catalog are current as of date of 5/2024. Contents are subject to change without notice for the purpose of improvements.
※ The HRS logo and "HIROSE" are trademarks of HIROSE ELECTRIC CO., LTD.