

Features

- $BV_{CEO} > -65V$ (BC856)
 $BV_{CEO} > -45V$ (BC857)
- $I_C = -100mA$ High Continuous Collector Current
- Low-Profile 0.6mm-High Package for Thin Applications
- Sidewall Tin Plating for Wettable Flanks in AOI
- **Totally Lead-Free & Fully RoHS Compliant (Notes 1 & 2)**
- **Halogen and Antimony Free. "Green" Device (Note 3)**
- **For automotive applications requiring specific change control (i.e. parts qualified to AEC-Q100/101/104/200, PPAP capable, and manufactured in IATF 16949 certified facilities), please contact us or your local Diodes representative.**
<https://www.diodes.com/quality/product-definitions/>

Mechanical Data

- Package: U-DFN1412-3/SWP (Type A)
- Package Material: Molded Plastic. "Green" Molding Compound.
- UL Flammability Rating 94V-0
- Moisture Sensitivity: Level 1 per J-STD-020
- Terminals: Finish – Matte Tin Plated Leads, Solderable per MIL-STD-202, Method 208 (E3)
- Weight: 0.0050 grams (Approximate)

U-DFN1412-3/SWP

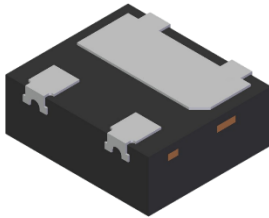

Bottom View

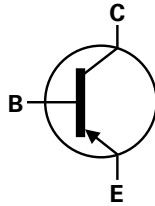

Device Symbol

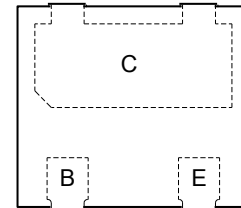
 Top View
Pin-Out

Ordering Information (Note 4)

Orderable Part Number	Package	Marking	Reel Size (inches)	Tape Width (mm)	Packing	
					Qty	Carrier
BC856AFSW-7	U-DFN1412-3/SWP (Type A)	4E	7	8	5,000	Reel
BC856BFSW-7	U-DFN1412-3/SWP (Type A)	4F	7	8	5,000	Reel
BC857AFSW-7	U-DFN1412-3/SWP (Type A)	4G	7	8	5,000	Reel
BC857BFSW-7	U-DFN1412-3/SWP (Type A)	4H	7	8	5,000	Reel
BC857CFSW-7	U-DFN1412-3/SWP (Type A)	4J	7	8	5,000	Reel

- Notes:
1. No purposely added lead. Fully EU Directive 2002/95/EC (RoHS), 2011/65/EU (RoHS 2) & 2015/863/EU (RoHS 3) compliant.
 2. See <https://www.diodes.com/quality/lead-free/> for more information about Diodes Incorporated's definitions of Halogen- and Antimony-free, "Green" and Lead-free.
 3. Halogen- and Antimony-free "Green" products are defined as those which contain <900ppm bromine, <900ppm chlorine (<1500ppm total Br + Cl) and <1000ppm antimony compounds.
 4. For packaging details, go to our website at <https://www.diodes.com/design/support/packaging/diodes-packaging/>.

Marking Information

U-DFN1412-3/SWP

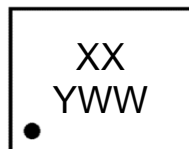

XX = Product type Marking Code
 YWW = Date Code Marking
 Y = Last Digit of Year (ex: 4 = 2024)
 WW = Week Code 01 to 53

Absolute Maximum Ratings (@T_A = +25°C, unless otherwise specified.)

Characteristic		Symbol	Value	Unit
Collector-Base Voltage	BC856	V _{CBO}	-80	V
	BC857		-50	
Collector-Emitter Voltage	BC856	V _{CEO}	-65	V
	BC857		-45	
Emitter-Base Voltage		V _{EB0}	-6	V
Continuous Collector Current		I _C	-100	mA
Peak Pulse Collector Current		I _{CM}	-200	mA
Peak Base Current		I _{BM}	-100	mA

Thermal Characteristics (@T_A = +25°C, unless otherwise specified.)

Characteristic		Symbol	Value	Unit
Power Dissipation	(Note 5)	P _D	450	mW
	(Note 6)		1.25	W
Thermal Resistance, Junction to Ambient	(Note 5)	R _{θJA}	278	°C/W
	(Note 6)		100	
Operating and Storage Temperature Range		T _J , T _{STG}	-55 to +150	°C

ESD Ratings (Note 7)

Characteristic	Symbol	Value	Unit	JEDEC Class
Electrostatic Discharge – Human Body Model	ESD HBM	4000	V	3A
Electrostatic Discharge – Charged Device Model	ESD CDM	1000	V	C3

- Notes:
5. For a device mounted with the exposed collector pads on minimum recommended pad layout that is on a single-sided 1.6mm FR4 PCB; device is measured under still air conditions whilst operating in a steady-state.
 6. Same as Note (5), except the device is mounted with 1-inch square pad and 2oz copper..
 7. Refer to JEDEC specification JESD22-A114 and JESD22-A115.

Thermal Characteristics and Derating Information

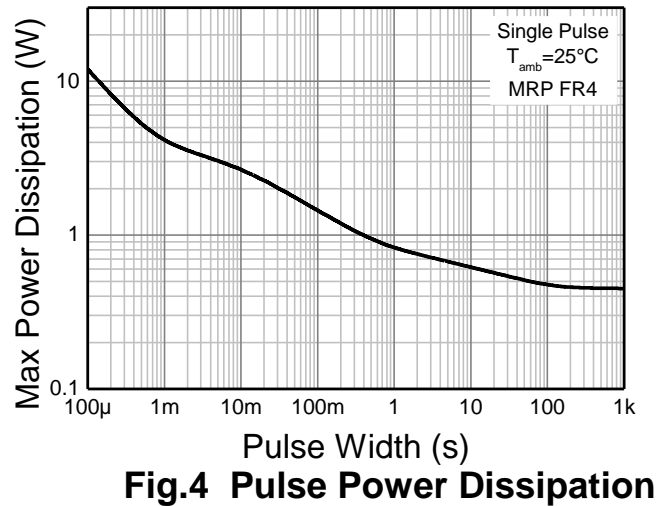
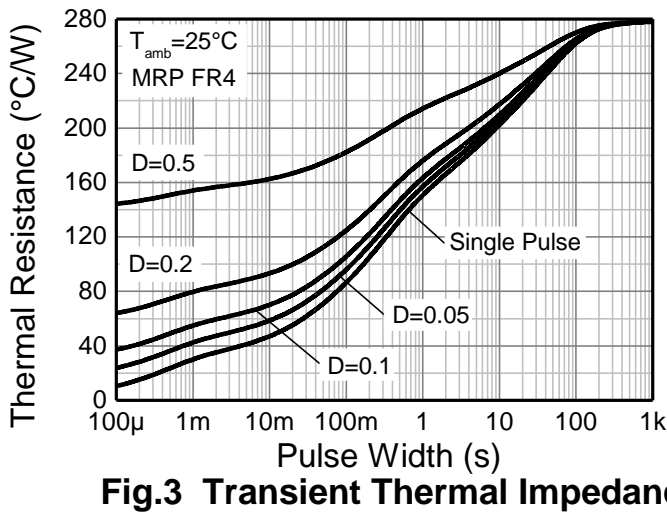
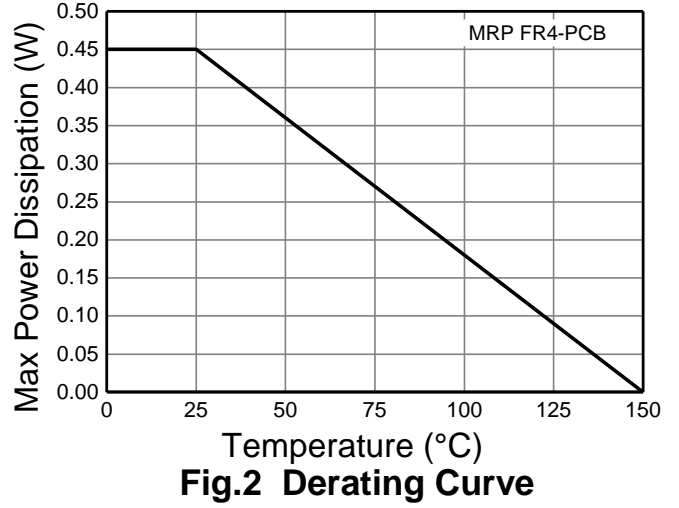
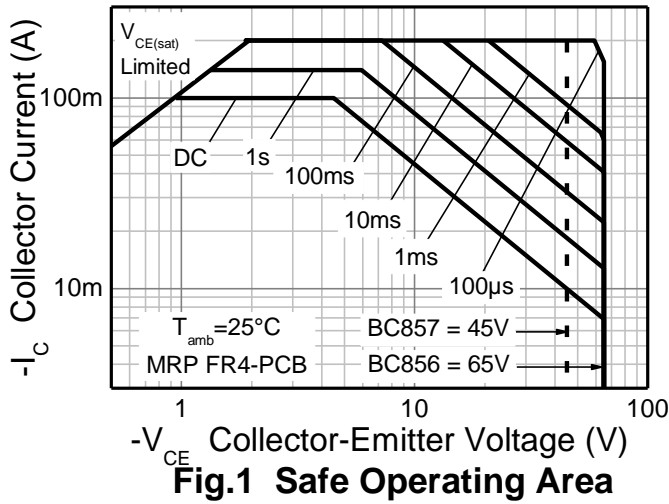

Electrical Characteristics (@T_A = +25°C, unless otherwise specified.)

Characteristic	Symbol	Min	Typ	Max	Unit	Test Conditions
Collector-Base Breakdown Voltage	BV _{CB0}	-80	—	—	V	I _C = -100μA
		BC856	-50			
Collector-Emitter Breakdown Voltage (Note 8)	BV _{CEO}	-65	—	—	V	I _C = -10mA
		BC857	-45			
Emitter-Base Breakdown Voltage	BV _{EBO}	-7	—	—	V	I _E = -100μA
Collector-Base Cutoff Current	I _{CBO}	—	—	-15	nA	V _{CB} = -30V, I _E = 0
		—	—	-5	μA	V _{CB} = -30V, I _E = 0, T _A = +150°C
Emitter-Base Cutoff Current	I _{EBO}	—	—	-100	nA	V _{EB} = -5.6V, I _C = 0
DC Current Gain	h _{FE}	125	—	250	—	V _{CE} = -5V, I _C = -2mA
		220	—	475		V _{CE} = -5V, I _C = -2mA
		420	—	800		V _{CE} = -5V, I _C = -2mA
Collector-Emitter Saturation Voltage (Note 8)	V _{CE(sat)}	—	—	-300	mV	I _C = -10mA, I _B = -0.5mA
		—	—	-650		I _C = -100mA, I _B = -5mA
Base-Emitter Turn-on Voltage (Note 8)	V _{BE(on)}	-600	—	-750	mV	V _{CE} = -5V, I _C = -2mA
		—	—	-820		V _{CE} = -5V, I _C = -10mA
Base-Emitter Saturation Voltage (Note 8)	V _{BE(sat)}	—	-700	—	V	I _C = -10mA, I _B = -0.5mA
		—	-850	—		I _C = -100mA, I _B = -5mA
Transition Frequency	f _T	100	—	—	MHz	V _{CE} = -5V, I _C = -10mA, f = 100MHz
Output (Collector) Capacitance	C _{obc}	—	2	—	pF	V _{CB} = -10V, f = 1MHz
Output (Emitter) Capacitance	C _{oec}	—	10	—	pF	V _{EB} = -0.5V, f = 1MHz
Noise Figure	NF	—	—	10	dB	V _{CE} = -5V, I _C = -200μA, R _S = 2kΩ, f = 1kHz BW=200Hz

Note: 8. Measured under pulsed conditions. Pulse width ≤ 300μs. Duty cycle ≤ 2%.

Typical Electrical Characteristics (@T_A = +25°C, unless otherwise specified.)

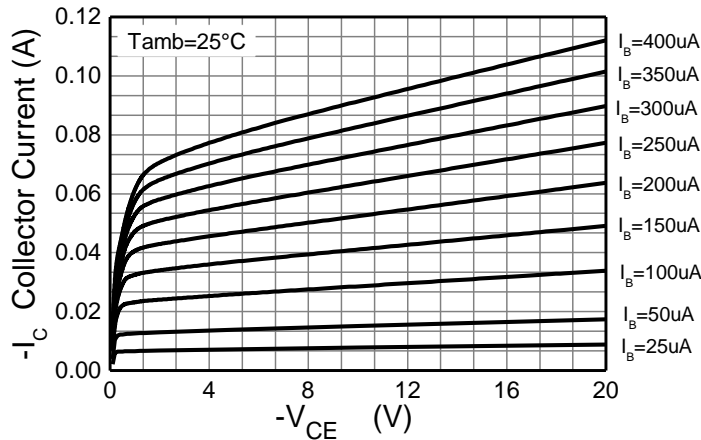
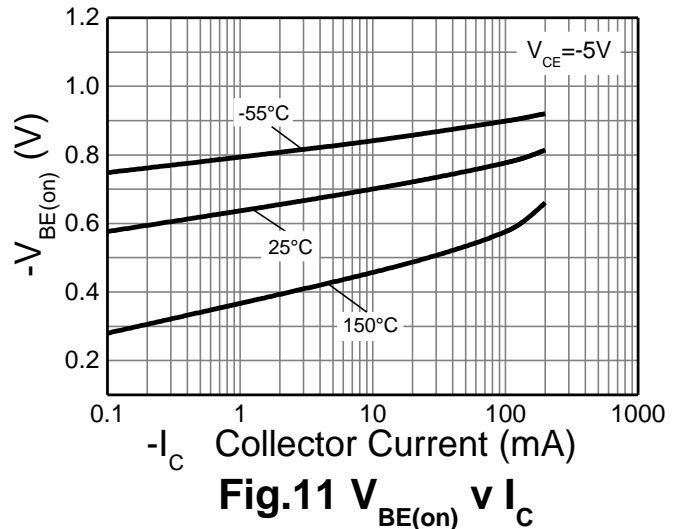
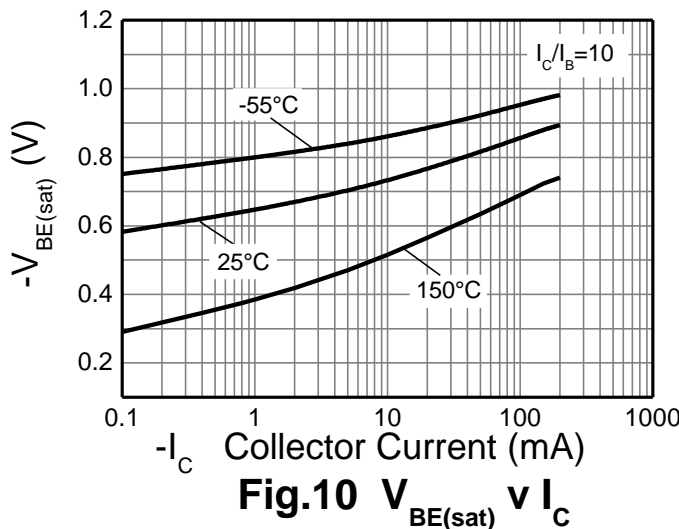
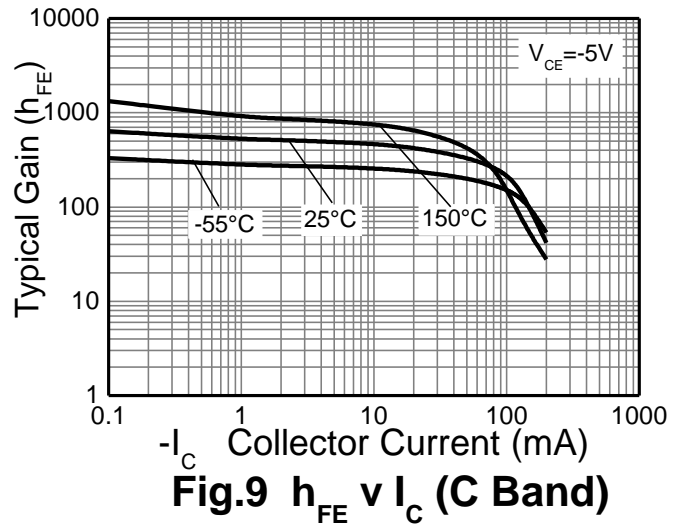
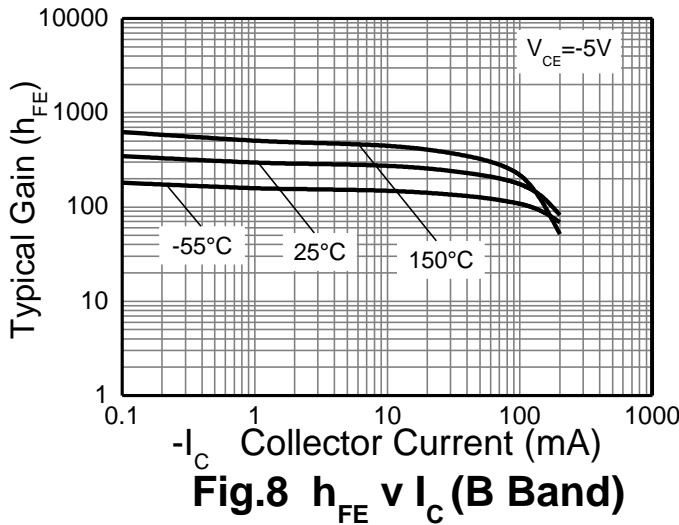
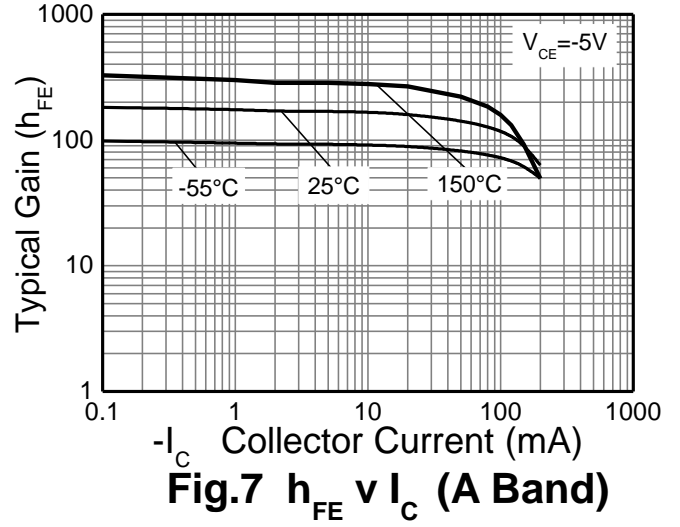
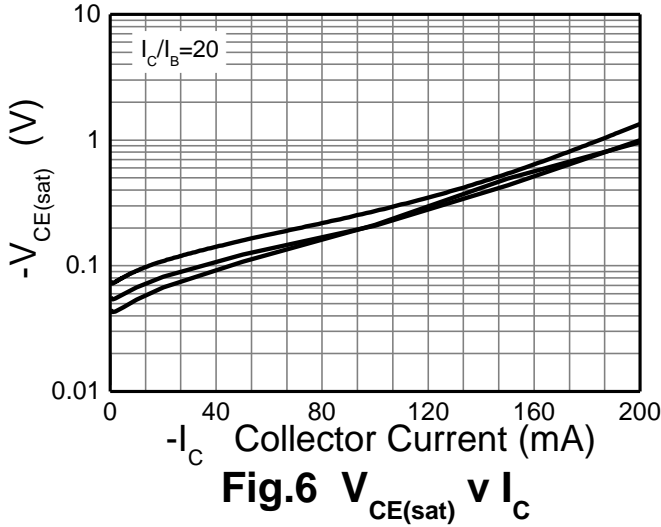

Fig.5 I_C v V_{CE}

Typical Electrical Characteristics (@T_A = +25°C, unless otherwise specified.) (continued)



Package Outline Dimensions

Please see <http://www.diodes.com/package-outlines.html> for the latest version.

U-DFN1412-3/SWP (Type A)

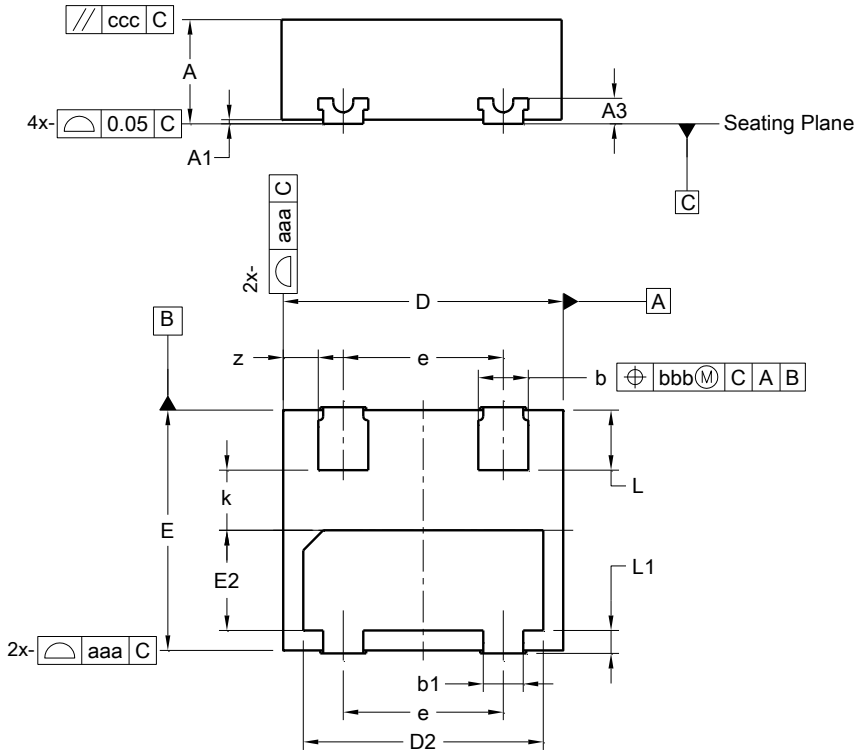

U-DFN1412-3/SWP (Type A)			
Dim	Min	Max	Typ
A	0.47	0.57	0.52
A1	0.00	0.05	0.03
A3	-	-	0.127
b	0.22	0.30	0.25
b1	0.15	0.25	0.20
D	1.35	1.45	1.40
D2	1.17	1.25	1.20
e	0.80 BSC		
E	1.15	1.25	1.20
E2	0.47	0.55	0.50
k	-	-	0.30
L	0.25	0.35	0.30
L1	0.065	0.165	0.115
z	-	-	0.175
aaa	0.25		
bbb	0.10		
ccc	0.10		
All Dimensions in mm			

Note: 9. Side wall tin plated package for wettable flanks in AOI.

Suggested Pad Layout

Please see <http://www.diodes.com/package-outlines.html> for the latest version.

U-DFN1412-3/SWP (Type A)

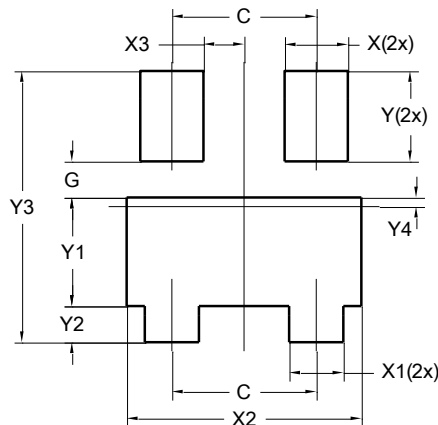

Dimensions	Value (in mm)
C	0.800
G	0.200
X	0.350
X1	0.300
X2	1.300
X3	0.225
Y	0.500
Y1	0.600
Y2	0.200
Y3	1.500

IMPORTANT NOTICE

1. DIODES INCORPORATED (Diodes) AND ITS SUBSIDIARIES MAKE NO WARRANTY OF ANY KIND, EXPRESS OR IMPLIED, WITH REGARDS TO ANY INFORMATION CONTAINED IN THIS DOCUMENT, INCLUDING, BUT NOT LIMITED TO, THE IMPLIED WARRANTIES OF MERCHANTABILITY, FITNESS FOR A PARTICULAR PURPOSE OR NON-INFRINGEMENT OF THIRD PARTY INTELLECTUAL PROPERTY RIGHTS (AND THEIR EQUIVALENTS UNDER THE LAWS OF ANY JURISDICTION).
2. The Information contained herein is for informational purpose only and is provided only to illustrate the operation of Diodes' products described herein and application examples. Diodes does not assume any liability arising out of the application or use of this document or any product described herein. This document is intended for skilled and technically trained engineering customers and users who design with Diodes' products. Diodes' products may be used to facilitate safety-related applications; however, in all instances customers and users are responsible for (a) selecting the appropriate Diodes products for their applications, (b) evaluating the suitability of Diodes' products for their intended applications, (c) ensuring their applications, which incorporate Diodes' products, comply the applicable legal and regulatory requirements as well as safety and functional-safety related standards, and (d) ensuring they design with appropriate safeguards (including testing, validation, quality control techniques, redundancy, malfunction prevention, and appropriate treatment for aging degradation) to minimize the risks associated with their applications.
3. Diodes assumes no liability for any application-related information, support, assistance or feedback that may be provided by Diodes from time to time. Any customer or user of this document or products described herein will assume all risks and liabilities associated with such use, and will hold Diodes and all companies whose products are represented herein or on Diodes' websites, harmless against all damages and liabilities.
4. Products described herein may be covered by one or more United States, international or foreign patents and pending patent applications. Product names and markings noted herein may also be covered by one or more United States, international or foreign trademarks and trademark applications. Diodes does not convey any license under any of its intellectual property rights or the rights of any third parties (including third parties whose products and services may be described in this document or on Diodes' website) under this document.
5. Diodes' products are provided subject to Diodes' Standard Terms and Conditions of Sale (<https://www.diodes.com/about/company/terms-and-conditions/terms-and-conditions-of-sales/>) or other applicable terms. This document does not alter or expand the applicable warranties provided by Diodes. Diodes does not warrant or accept any liability whatsoever in respect of any products purchased through unauthorized sales channel.
6. Diodes' products and technology may not be used for or incorporated into any products or systems whose manufacture, use or sale is prohibited under any applicable laws and regulations. Should customers or users use Diodes' products in contravention of any applicable laws or regulations, or for any unintended or unauthorized application, customers and users will (a) be solely responsible for any damages, losses or penalties arising in connection therewith or as a result thereof, and (b) indemnify and hold Diodes and its representatives and agents harmless against any and all claims, damages, expenses, and attorney fees arising out of, directly or indirectly, any claim relating to any noncompliance with the applicable laws and regulations, as well as any unintended or unauthorized application.
7. While efforts have been made to ensure the information contained in this document is accurate, complete and current, it may contain technical inaccuracies, omissions and typographical errors. Diodes does not warrant that information contained in this document is error-free and Diodes is under no obligation to update or otherwise correct this information. Notwithstanding the foregoing, Diodes reserves the right to make modifications, enhancements, improvements, corrections or other changes without further notice to this document and any product described herein. This document is written in English but may be translated into multiple languages for reference. Only the English version of this document is the final and determinative format released by Diodes.
8. Any unauthorized copying, modification, distribution, transmission, display or other use of this document (or any portion hereof) is prohibited. Diodes assumes no responsibility for any losses incurred by the customers or users or any third parties arising from any such unauthorized use.
9. This Notice may be periodically updated with the most recent version available at <https://www.diodes.com/about/company/terms-and-conditions/important-notice>

The Diodes logo is a registered trademark of Diodes Incorporated in the United States and other countries.
All other trademarks are the property of their respective owners.
© 2024 Diodes Incorporated. All Rights Reserved.

www.diodes.com