



■ Features

- Ultra slim design with 105mm(6SU) width
- Universal input 85~264VAC(277VAC operational)
- No load power consumption<0.3W
- Isolation class II
- DC output voltage adjustable
- Protections : Short circuit / Overload / Over voltage
- Cooling by free air convection
- DIN rail TS-35/7.5 or 15 mountable
- Over voltage category III
- LED indicator for power on
- 3 years warranty

■ Applications

- Household control system
- Building automation
- Industrial control system
- Factory automation
- Electro-mechanical apparatus

■ GTIN CODE

MW Search : <https://www.meanwell.com/serviceGTIN.aspx>

■ Description

HDR-150 is an economical ultra slim 150W DIN rail power supply series, adapt to be installed on TS-35/7.5 or TS-35/15 mounting rails. The body is designed 105mm(6SU) in width, which allows space saving inside the cabinets. The entire series adopts the full range AC input from 85VAC to 264VAC(277VAC operational) and conforms to BS EN/EN61000-3-2, the norm the European Union regulates for harmonic current.

HDR-150 is designed with plastic housing that it can effectively prevent user from electric hazards. With working efficiency up to 90.5%, the entire series can operate at the ambient temperature between -30°C and 70°C under air convection. The complete protection functions and relevant certificates for home automations and industrial control apparatus (IEC62368-1,UL62368-1,UL61010, BS EN/EN61558-2-16) make HDR-150 a very competitive power supply solution for household and industrial applications.

■ Model Encoding

HDR - 150 - 12

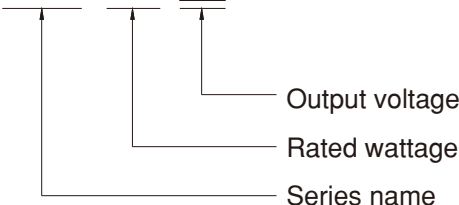

SPECIFICATION

MODEL		HDR-150-12	HDR-150-15	HDR-150-24	HDR-150-48	
OUTPUT	DC VOLTAGE	12V	15V	24V	48V	
	RATED CURRENT	115VAC	10.2A	8.55A	5.31A	2.72A
		230VAC	11.3A	9.5A	6.25A	3.2A
	RATED POWER	115VAC	122.4W	128.3W	127.4W	130.6W
		230VAC	135.6W	142.5W	150W	153.6W
	RIPPLE & NOISE (max.)	Note.2 100mVp-p	120mVp-p	150mVp-p	200mVp-p	
	VOLTAGE ADJ. RANGE	10.8~ 13.8V	13.5 ~ 18V	21.6 ~ 29V	43.2 ~ 55.2V	
	VOLTAGE TOLERANCE	Note.3 ± 2.0%	± 1.0%	± 1.0%	± 1.0%	
	LINE REGULATION	± 1.0%	± 1.0%	± 1.0%	± 1.0%	
	LOAD REGULATION	± 1.0%	± 1.0%	± 1.0%	± 1.0%	
SETUP, RISE TIME	500ms, 60ms/230VAC 500ms, 60ms/115VAC at full load					
HOLD UP TIME (Typ.)	30ms/230VAC 12ms/115VAC at full load					
INPUT	VOLTAGE RANGE	85 ~ 264VAC (277VAC operational)		120 ~ 370VDC (390VDC operational)		
	FREQUENCY RANGE	47 ~ 63Hz				
	EFFICIENCY (Typ.)	89%	89.5%	90.5%	90.5%	
	AC CURRENT (Typ.)	3A/115VAC 1.6A/230VAC				
	INRUSH CURRENT (Typ.)	COLD START 35A/115VAC		70A/230VAC		
PROTECTION	OVERLOAD	105 ~ 135% rated output power Hiccup mode when output voltage <50%, recovers automatically after fault condition is removed Constant current limiting within 50% ~100% rated output voltage, recovers automatically after fault condition is removed				
	OVER VOLTAGE	14.2 ~ 16.2V	18.8 ~ 22.5V	30 ~ 36V	56.5 ~ 64.8V	
		Protection type : Shut down o/p voltage, re-power on to recover				
ENVIRONMENT	WORKING TEMP.	-30 ~ +70°C (Refer to "Derating Curve")				
	WORKING HUMIDITY	20 ~ 90% RH non-condensing				
	STORAGE TEMP., HUMIDITY	-40 ~ +85°C, 10 ~ 95% RH non-condensing				
	TEMP. COEFFICIENT	± 0.03%/°C (0 ~ 45°C) RH non-condensing				
	VIBRATION	10 ~ 500Hz, 2G 10min./1cycle, period for 60min. each along X, Y, Z axes; Mounting: Compliance to IEC60068-2-6				
	OPERATING ALTITUDE	2000 meters (Note 4)				
	OVER VOLTAGE CATEGORY	III ; According to EN62368,EN61558, EN50178,EN60664-1, EN62477-1 ; altitude up to 2000 meters				
SAFETY & EMC (Note.7)	SAFETY STANDARDS	IEC62368-1, UL62368-1, UL61010, TUV BS EN/EN61558-2-16, BS EN/EN61558-1, EAC TP TC 004,BIS IS13252(Part1): 2010/IEC 609501:2005(except for 48) approved; Design refer to BS EN/EN50178, TUV BS EN/EN62368-1				
	WITHSTAND VOLTAGE	I/P-O/P:4KVAC				
	ISOLATION RESISTANCE	I/P-O/P:100M Ohms / 500VDC / 25°C / 70% RH				
	EMC EMISSION	Parameter	Standard		Test Level / Note	
		Conducted	BS EN/EN55032(CISPR32)		Class B	
		Radiated	BS EN/EN55032(CISPR32)		Class B (note 5)	
		Harmonic Current (Note 6)	BS EN/EN61000-3-2		Class A	
		Voltage Flicker	BS EN/EN61000-3-3		-----	
	EMC IMMUNITY	BS EN/EN55024, BS EN/EN61000-6-2				
		Parameter	Standard		Test Level /Note	
ESD		BS EN/EN61000-4-2		Level 3, 8KV air; Level 2, 4KV contact, criteria A		
Radiated Susceptibility		BS EN/EN61000-4-3		Level 3, criteria A		
EFT/Burest		BS EN/EN61000-4-4		Level 3, criteria A		
Surge		BS EN/EN61000-4-5		Level 4,2KV/L-N, criteria A		
Conducted		BS EN/EN61000-4-6		Level 3, criteria A		
Magnetic Field		BS EN/EN61000-4-8		Level 4, criteria A		
Voltage Dips and interruptions	BS EN/EN61000-4-11		>95% dip 0. 5 periods, 30% dip 25 periods, >95% interruptions 250 periods			
OTHERS	MTBF	3046.3K hrs min. Telcordia SR-332 (Bellcore) ; 535.9K hrs min. MIL-HDBK-217F (25°C)				
	DIMENSION	105*90*54.5mm (W*H*D)				
	PACKING	0.31Kg; 32pcs/11Kg/1.0CUFT				
NOTE	<p>1. All parameters NOT specially mentioned are measured at 230VAC input, rated load and 25°C of ambient temperature.</p> <p>2. Ripple & noise are measured at 20MHz of bandwidth by using a 12" twisted pair-wire terminated with a 0.1 μF & 47 μF parallel capacitor.</p> <p>3. Tolerance : includes set up tolerance, line regulation and load regulation.</p> <p>4. The ambient temperature derating of 3.5°C/1000m with fanless models and of 5°C/1000m with fan models for operating altitude higher than 2000m(6500ft).</p> <p>5. When the input voltage is 230VAC,delivers EMI Class B for radiated emission for the power supply; When the input voltage is 110VAC, delivers EMI Class A for radiated emission for the power supply.</p> <p>6. Harmonic current test at 70% load .</p> <p>7. The power supply is considered as an independent unit, but the final equipment still need to re-confirm that the whole system complies with the EMC directives. For guidance on how to perform these EMC tests, please refer to "EMI testing of component power supplies." (as available on https://www.meanwell.com/Upload/PDF/EMI_statement_en.pdf)</p> <p>※ Product Liability Disclaimer : For detailed information, please refer to https://www.meanwell.com/serviceDisclaimer.aspx</p>					

■ Block Diagram

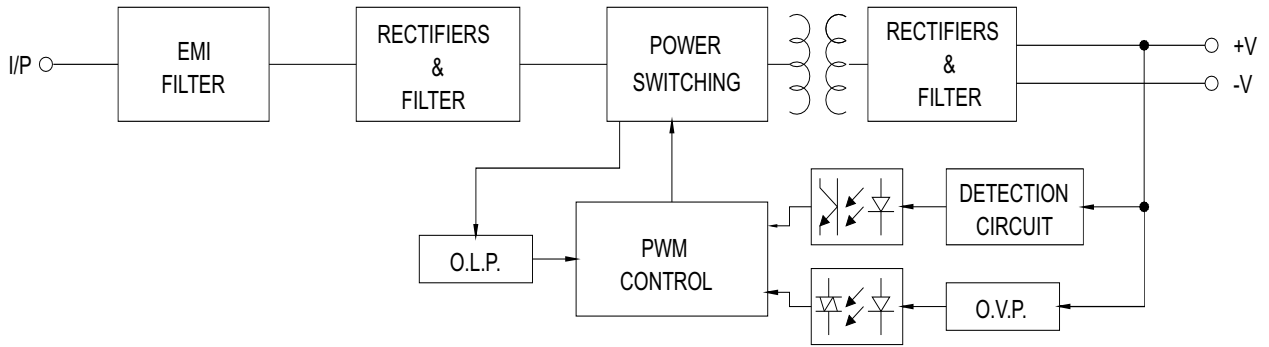

■ Derating Curve VS Ambient Temperature

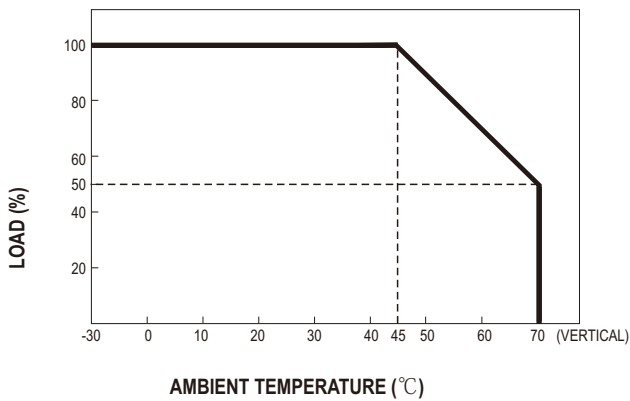

■ Output Derating VS Input Voltage

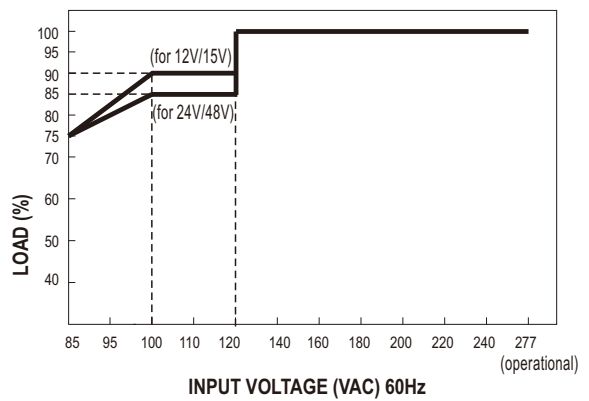

Mechanical Specification

(Unit: mm , tolerance $\pm 0.5\text{mm}$)

Case No.HDR-150

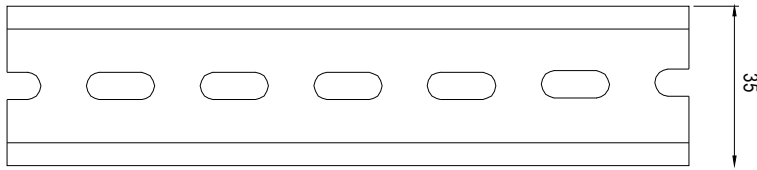
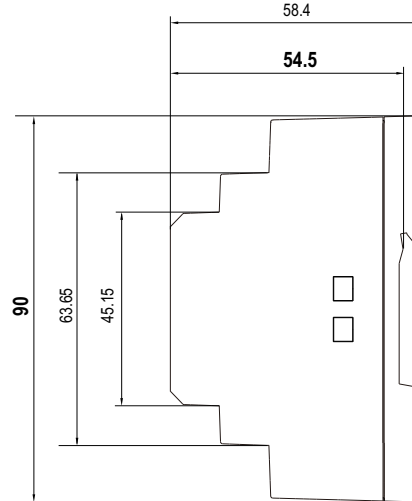
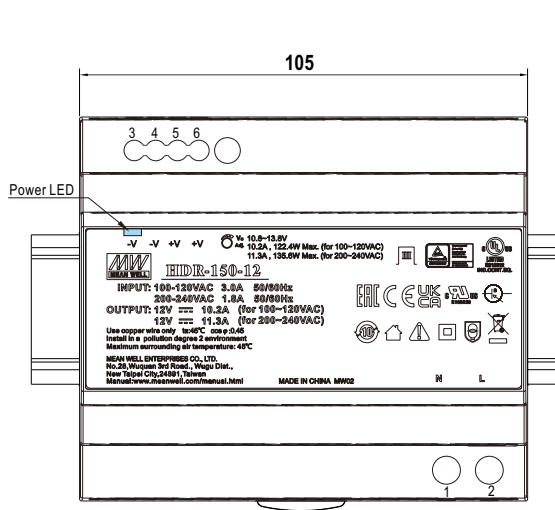

ADMISSIBLE DIN-RAIL: TS35/7.5 OR TS35/15

Terminal Pin No. Assignment

Pin No.	Assignment	Pin No.	Assignment
1	AC/N	3,4	-V
2	AC/L	5,6	+V

Installation Manual

Please refer to : <http://www.meanwell.com/manual.html>