



Wire & Cable > Hook Up Wire > SAE AS22759: 34/35/41/42/43 - Dual-Wall, Normal Weight Wire



Cable Type: MIL-DTL-22759

Operating Voltage: 600 V

Wire & Cable Insulation Material: Modified Radiation Cross-linked ETFE Polymer

Conductor Material: Tin-Coated Copper

Wire Size: 22 AWG

[All SAE AS22759: 34/35/41/42/43 - Dual-Wall, Normal Weight Wire \(235\)](#)

Features

Product Type Features

Cable Style	Primary
-------------	---------

Configuration Features

Number of Strands	19
Number of Conductors	1

Electrical Characteristics

Operating Voltage	600 V
-------------------	-------

Body Features

Wire & Cable Insulation Material	Modified Radiation Cross-linked ETFE Polymer
Conductor Material	Tin-Coated Copper
Wire Color (Base)	Black

Dimensions

Strand Size	.009 in
Strand Size	34 AWG
Outside Cable Diameter	1.27 mm[.05 in]
Conductor Diameter Range	.7 – .8 mm[.027 – .031 in]



Wire Size	22 AWG
-----------	--------

Usage Conditions

Cable Type	MIL-DTL-22759
Operating Temperature Range	-65 – 150 °C[-85 – 302 °F]

Other

Product Source	US
----------------	----

Product Compliance

[For compliance documentation, visit the product page on TE.com>](#)

EU RoHS Directive 2011/65/EU	Compliant
EU ELV Directive 2000/53/EC	Compliant
China RoHS 2 Directive MIIT Order No 32, 2016	有害物质含量符合标准要求 No Restricted Substance(s) Above Threshold
EU REACH Regulation (EC) No. 1907/2006	Current ECHA Candidate List: JUNE 2025 (250) Candidate List Declared Against: JUNE 2025 (250) Does not contain REACH SVHC
Halogen Content	Out of Scope - excluded from Halogen requirements
Solder Process Capability	Not applicable for solder process capability

Product Compliance Disclaimer

This information is provided based on reasonable inquiry of our suppliers and represents our current actual knowledge based on the information they provided. This information is subject to change. The part numbers that TE has identified as EU RoHS compliant have a maximum concentration of 0.1% by weight in homogenous materials for lead, hexavalent chromium, mercury, PBB, PBDE, DBP, BBP, DEHP, DIBP, and 0.01% for cadmium, or qualify for an exemption to these limits as defined in the Annexes of Directive 2011/65/EU (RoHS2). Finished electrical and electronic equipment products will be CE marked as required by Directive 2011/65/EU. Components may not be CE marked. Additionally, the part numbers that TE has identified as EU ELV compliant have a maximum concentration of 0.1% by weight in homogenous materials for lead, hexavalent chromium, and mercury, and 0.01% for cadmium, or qualify for an exemption to these limits as defined in the Annexes of Directive 2000/53/EC (ELV). Regarding the REACH Regulation, the information TE provides on SVHC in articles for this part number is based on the latest European Chemicals Agency (ECHA) 'Guidance on requirements for substances in articles' posted at this URL: <https://echa.europa.eu/guidance-documents/guidance-on-reach>

Compatible Parts

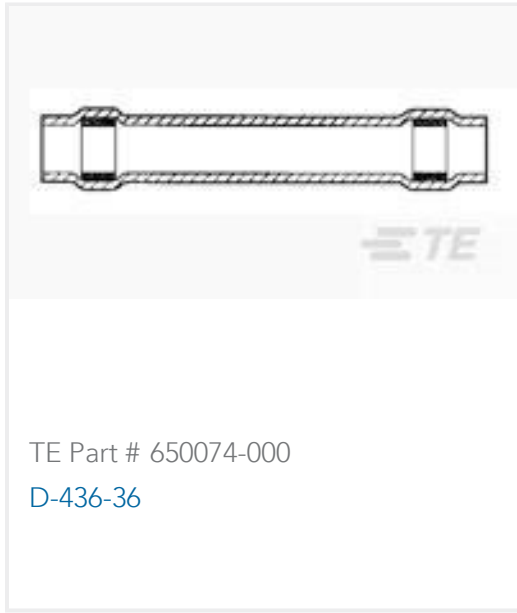

Customers Also Bought

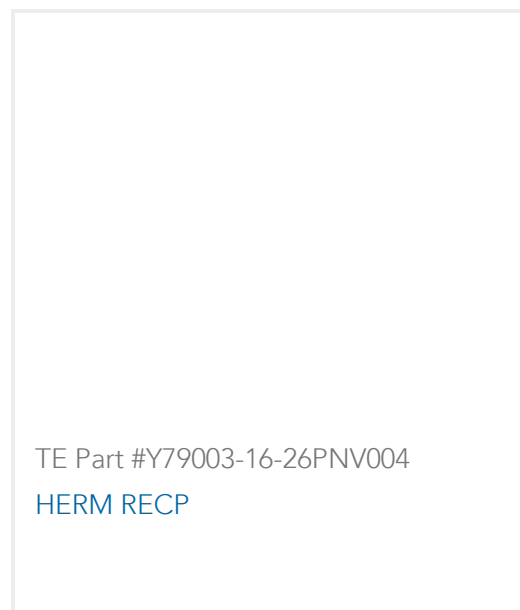
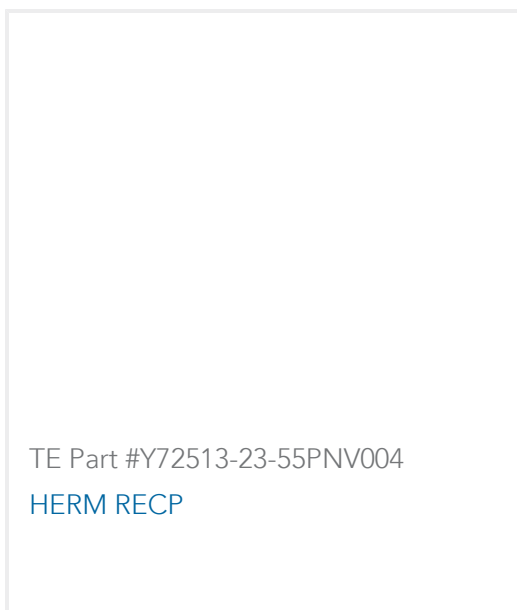
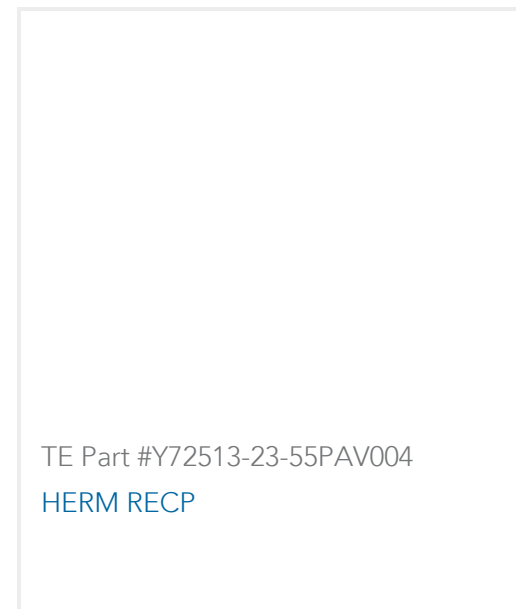
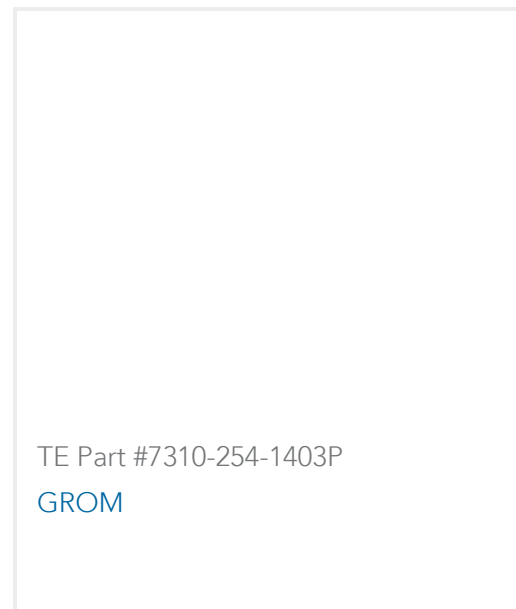
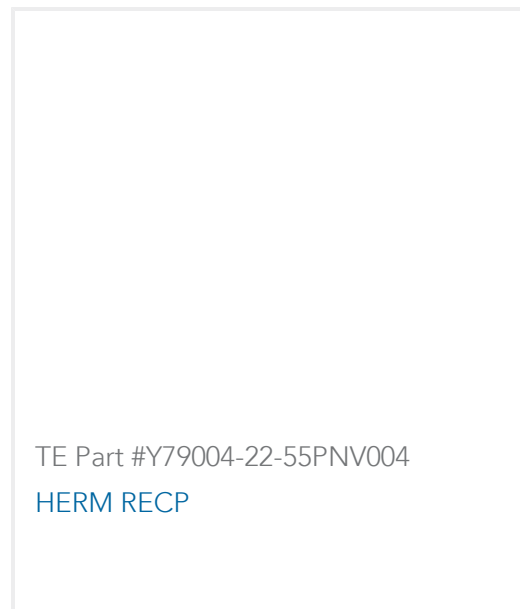
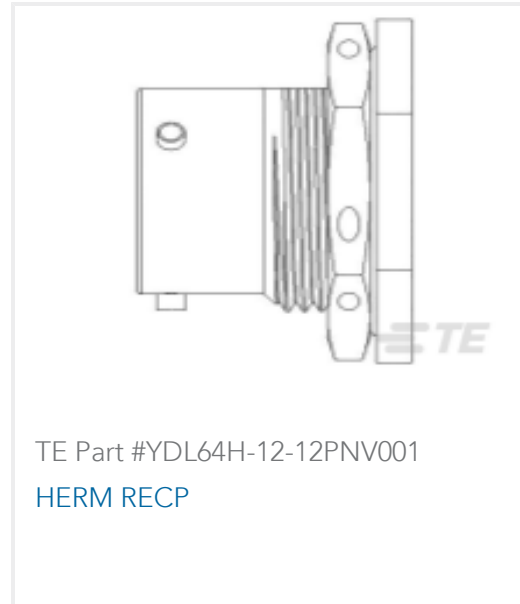

Documents

Product Drawings

[22759/34-22-0](#)

English

Datasheets & Catalog Pages

[Raychem Wire and Cable Quick Reference Guide](#)

English