

DATASHEET

# Billi

SR43W078 • lamiiANT<sup>®</sup>



## Features

- Antenna for the 2.4–2.5GHz, 4.9-5.9GHz and 5.925-7.125GHz Wi-Fi6E & WiFi7 bands
- 802.11a/b/g/j/n/ac/ax
- The new band for Wi-Fi6E & Wi-Fi7 (5.925-7.125GHz) provides 1200MHz extra bandwidth
- Maintains high performance within device: DFI (Designed For Integration)
- High efficiency within small area

# Contents

<b>1.</b>	<b>Description</b>	<b>2</b>
<b>2.</b>	<b>Applications</b>	<b>2</b>
<b>3.</b>	<b>General data</b>	<b>2</b>
<b>4.</b>	<b>Part number</b>	<b>3</b>
<b>5.</b>	<b>RF characteristics</b>	<b>3</b>
<b>6.</b>	<b>RF performance</b>	<b>4</b>
<b>6.1.</b>	Return loss	4
<b>6.2.</b>	VSWR	4
<b>6.3.</b>	Efficiency	5
<b>6.4.</b>	Antenna pattern	6
<b>7.</b>	<b>Antenna dimensions</b>	<b>9</b>
<b>8.</b>	<b>Schematic symbol and pin definition</b>	<b>10</b>
<b>9.</b>	<b>Host PCB footprint</b>	<b>10</b>
<b>10.</b>	<b>Electrical interface</b>	<b>11</b>
<b>10.1.</b>	Transmission line	11
<b>10.2.</b>	Matching circuit	11
<b>11.</b>	<b>Antenna integration guide</b>	<b>12</b>
<b>11.1.</b>	Antenna placement	12
<b>11.2.</b>	Host PCB layout	13
<b>11.3.</b>	Host PCB clearance	13
<b>12.</b>	<b>Reference board</b>	<b>14</b>
<b>12.1.</b>	Reference board matching circuit	14
<b>13.</b>	<b>Soldering</b>	<b>15</b>
<b>14.</b>	<b>Hazardous material regulation conformance</b>	<b>15</b>
<b>15.</b>	<b>Packaging</b>	<b>15</b>
<b>15.1.</b>	Optimal storage conditions	15
<b>15.2.</b>	Tape characteristics	16
<b>15.3.</b>	Reel dimensions	17
<b>15.4.</b>	Box dimensions	17
<b>15.5.</b>	Bag properties	18
<b>15.6.</b>	Reel label information	18

## 1. Description

---

Billi is a Surface Mount Wi-Fi6E antenna with high efficiency in a small area. The Billi antenna is designed for pick-and-place assembly. The antenna covers the Wi-Fi6E & Wi-Fi7 bands: 2.4-2.5 GHz, 4.9-5.9GHz and 5.925-7.125GHz

## 2. Applications

---

- Wi-Fi6E & Wi-Fi7 Routers
- Wi-Fi6E & Wi-Fi7 Portable Devices
- Wi-Fi6E & Wi-Fi7 surveillance cameras
- USB dongles for Wi-Fi6E & Wi-Fi7
- Game Consoles
- Set-Top Boxes
- MIMO Systems

## 3. General data

---

FREQUENCY	2400-2500MHz 4900-5900MHz 5925-7125MHz
POLARIZATION	Linear
OPERATING TEMPERATURE	-40°C to 85°C
ENVIRONMENTAL CONDITION TEST	ISO16750-4 5.1.1./5.1.2
IMPEDANCE WITH MATCHING	50 Ω
WEIGHT	<0.5g
ANTENNA TYPE	SMD
DIMENSIONS	15.0 x 6.0 x 1.0 (mm)

## 4. Part number

BILLI  
SR43W078

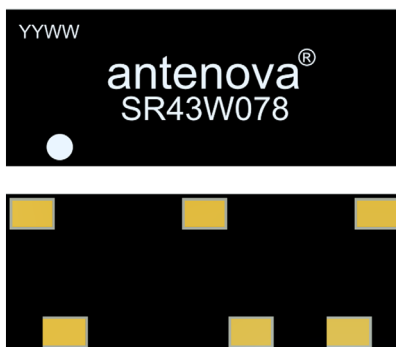

## 5. RF characteristics

All data measured on Antenova's evaluation PCB Part No. SR43W078-EVB-1

FREQUENCY	2400 – 2500 MHZ	4900 – 5900 MHZ	5925 – 7125 MHZ
PEAK GAIN	2.9dBi	4.7dBi	4.9dBi
AVERAGE GAIN (LINEAR)	-1.6dB	-2.6 dB	-2.1 dB
AVERAGE EFFICIENCY	70%	60%	65%
MAXIMUM RETURN LOSS	-10.0dB	-7.5dB	-7.5dB
MAXIMUM VSWR	2:1	2.45:1	2.45:1

## 6. RF performance

### 6.1. Return loss

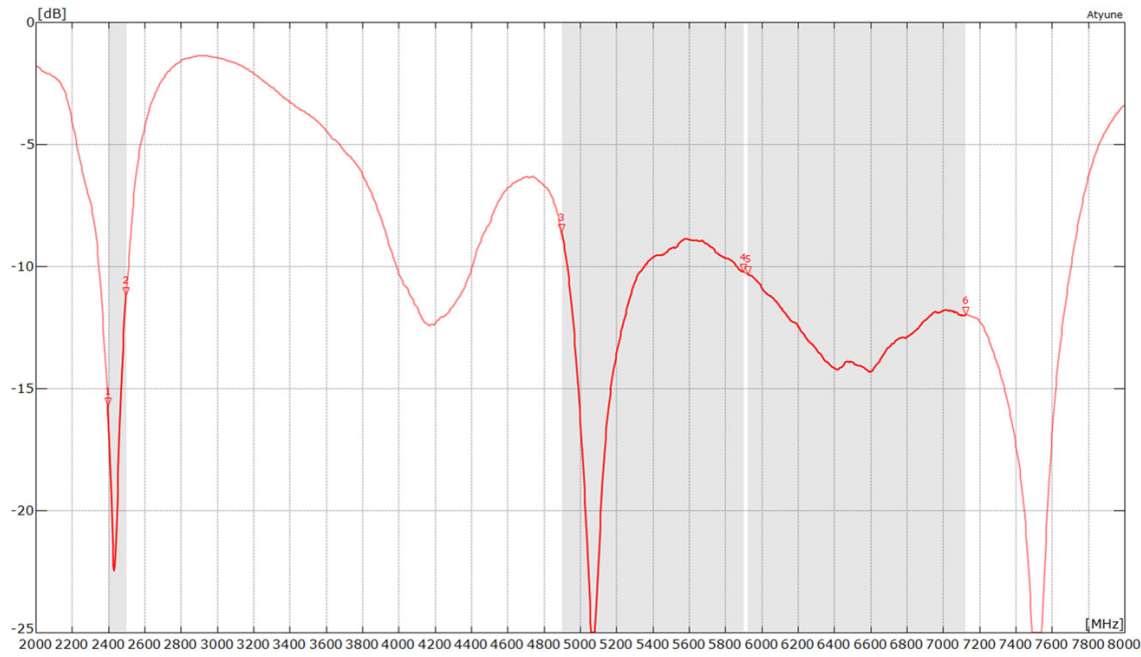

### 6.2. VSWR

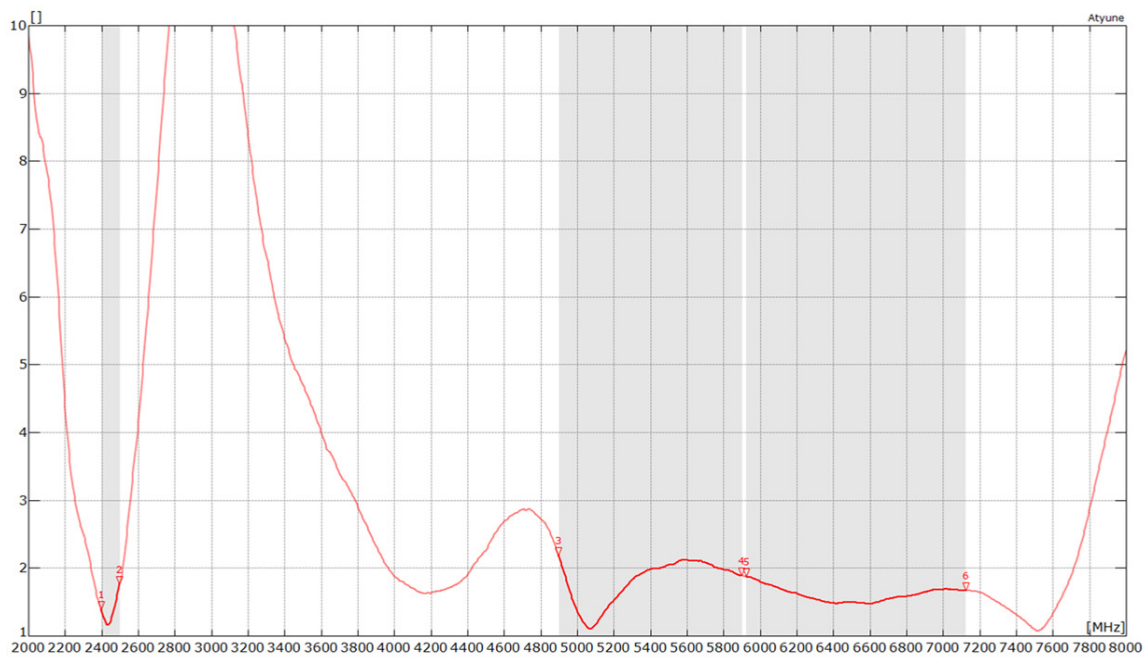

All data measured on Antenova's evaluation PCB Part No. SR43W078-EVB-1

### 6.3. Efficiency

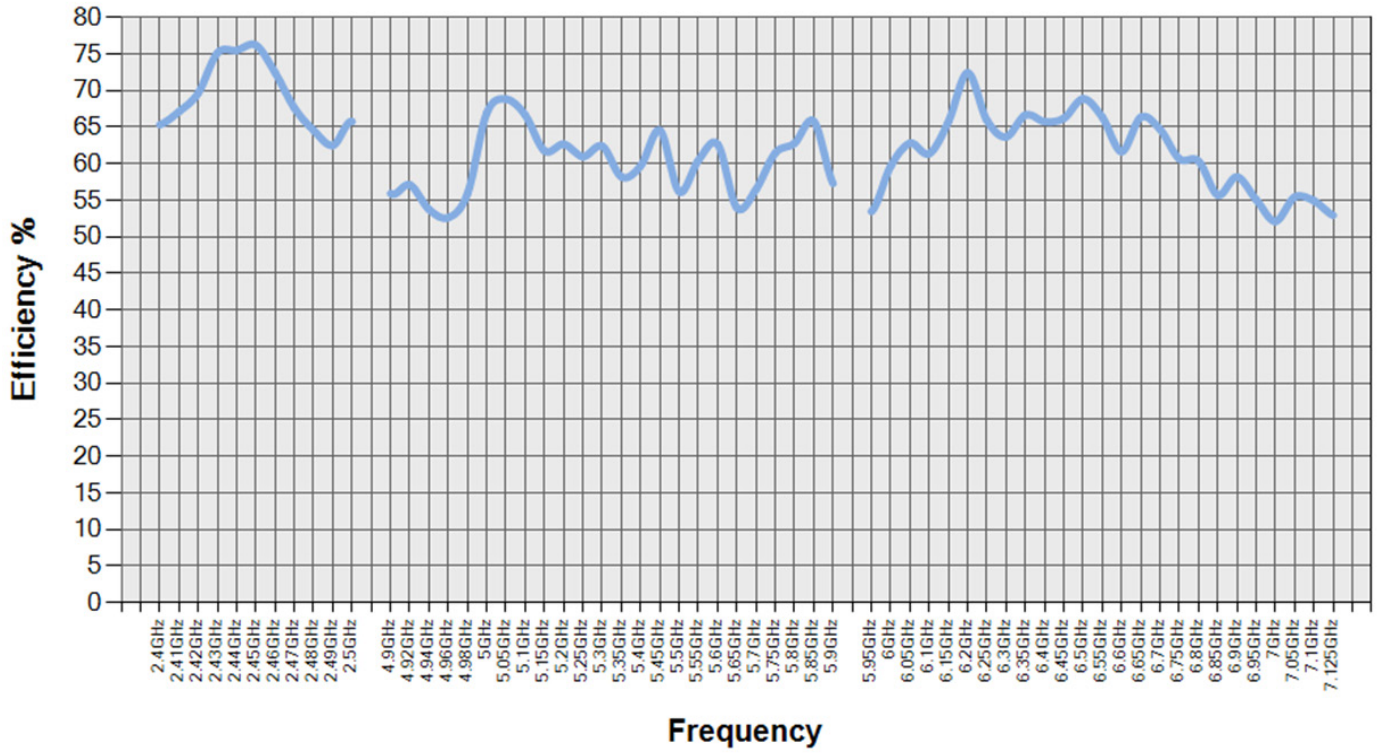

All data measured on Antenova's evaluation PCB Part No. SR43W078-EVB-1

## 6.4. Antenna pattern

### 6.4.1. 2400 MHz – 2500 MHz

3D pattern at 2450MHz

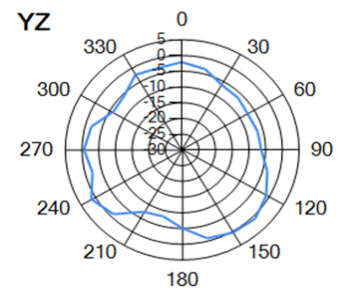
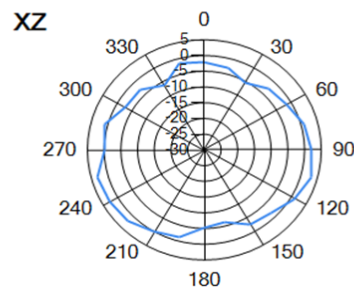
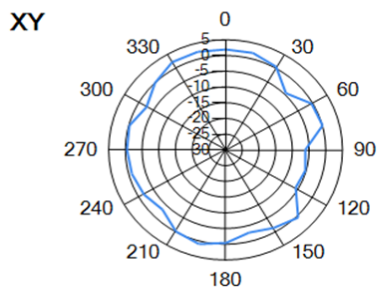
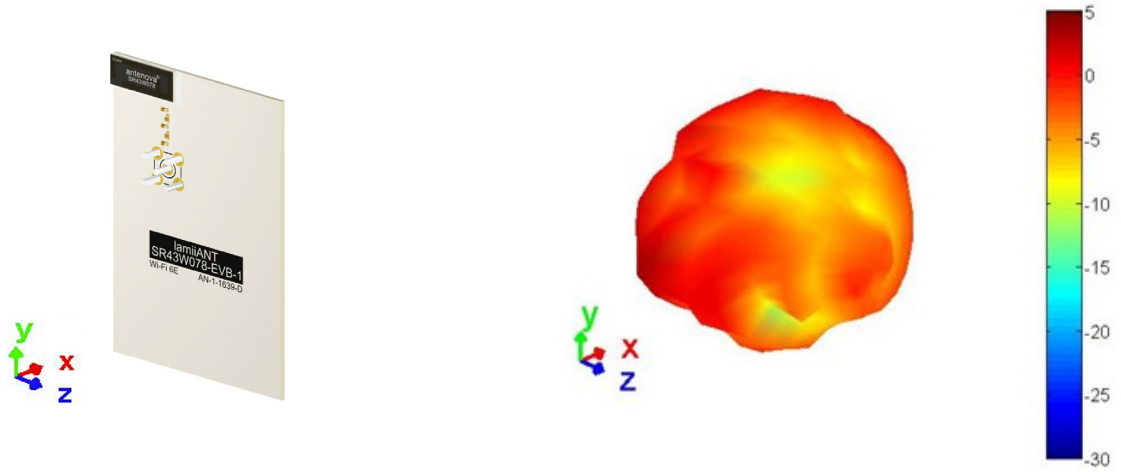

— 2.45GHz

6.4.2. 4900 MHz – 5900 MHz

3D pattern at 5500MHz

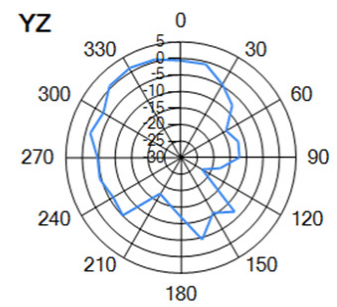
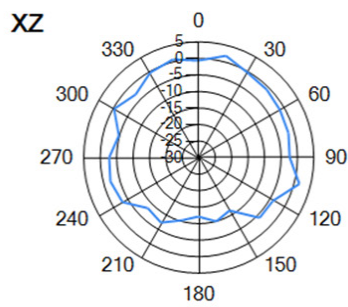
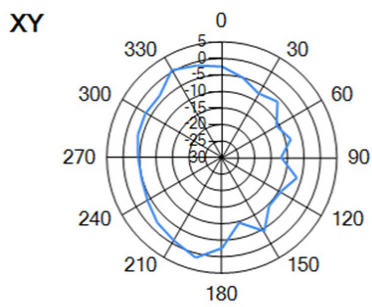
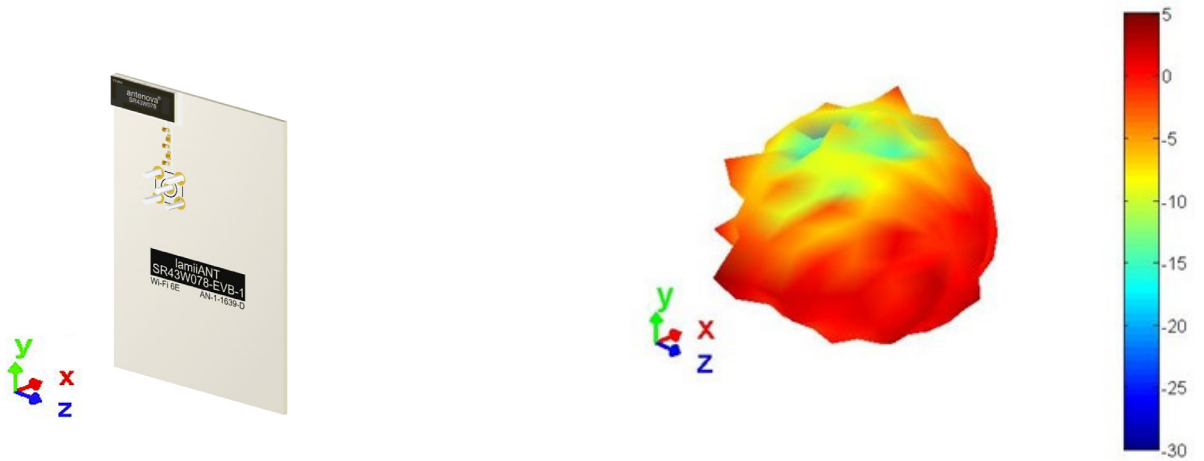

— 5.5GHz

6.4.3. 5925 MHz – 7125 MHz

3D pattern at 6550MHz

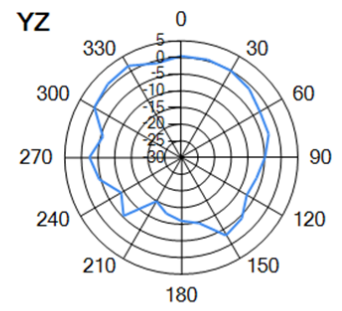
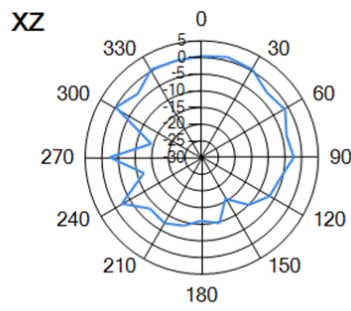
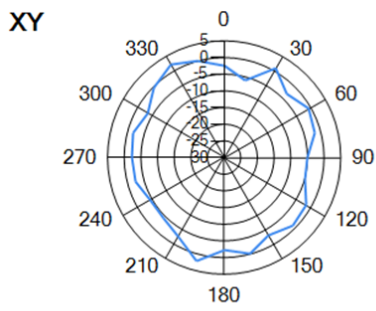
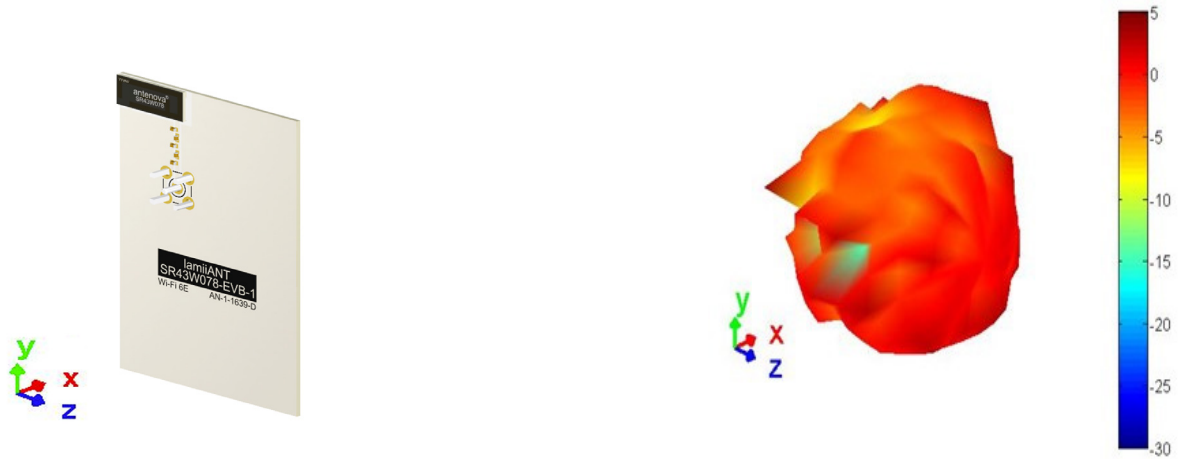

— 6.55GHz

## 7. Antenna dimensions



Top view

L	W	T
Length	Width	Thickness
15.0 ±0.1	6.0 ±0.1	1.00(nominal)

All dimensions in (mm)

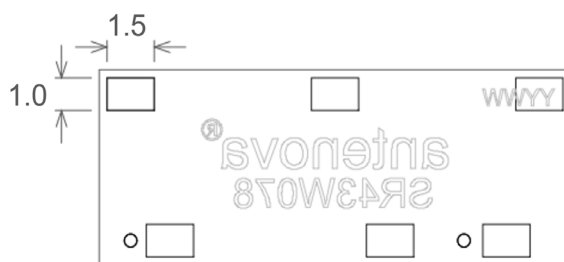
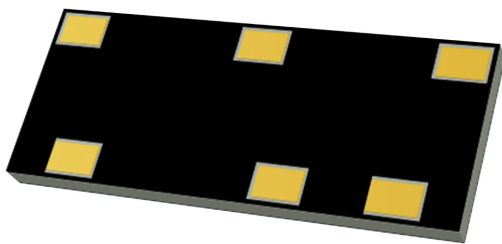

Bottom view

## 8. Schematic symbol and pin definition

The circuit symbol for the antenna is shown below. The antenna has 6 pins with only 2 as functional. All other pins are for mechanical strength.

PIN	DESCRIPTION
3	Feed
1	GND
2, 4, 5, 6	Not used (Mechanical only)

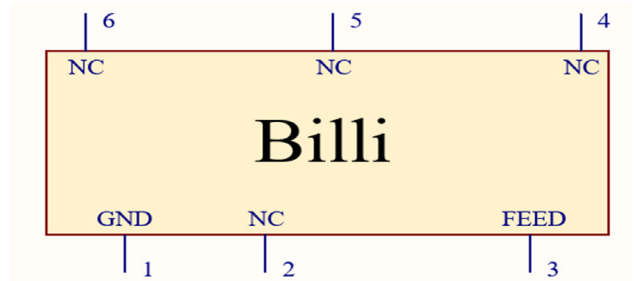

## 9. Host PCB footprint

The recommended host PCB footprint is below.

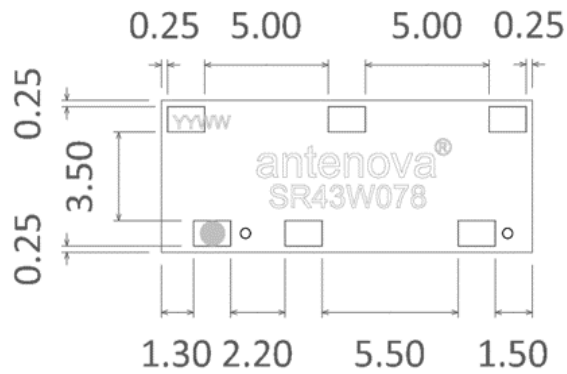

6 copper pads all 1.5 x 1.0 (mm)

## 10. Electrical interface

### 10.1. Transmission line

All transmission lines should be designed to have a characteristic impedance of 50Ω.

- The length of each transmission lines should be kept to a minimum
- All other parts of the RF system like transceivers, power amplifiers, etc, should also be designed to have a 50 Ω impedance

A co-planar transmission line can be designed using an online transmission line calculator tool, such as:

<https://blog.antenova.com/rf-transmission-line-calculator>

The PCB thickness, copper thickness and substrate dielectric constant are entered, then the tool calculates the transmission line width and gaps on either side of the track to give a 50 Ω impedance.

### 10.2. Matching circuit

The antenna requires a matching circuit that must be optimized for each product. The matching circuit will require up to six components and the following circuit should be designed into the host PCB. Not all components may be required but should be included as a precaution. The matching network should be placed close to the antenna feed to ensure it is optionally effective in tuning the antenna.

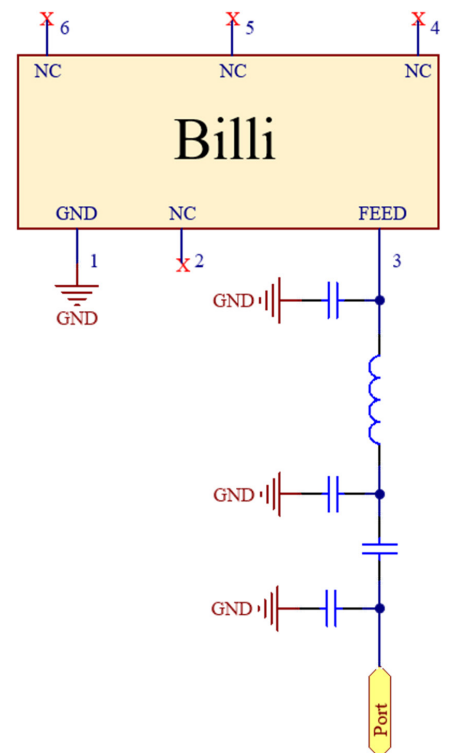

## 11. Antenna integration guide

We recommend the following during the design phase to maximise antenna performance and minimize noise:

- Minimum 4 layer PCB
- Route signals and power internally where possible
- Flood all layers with ground
- Knit ground on all layers together with plenty of vias

Follow placement guidance carefully. Antenova provide technical support to help you with your design, and also provide design assistance on PTCRB certification. Register for an account on <https://ask.antenova.com/> to access technical support.

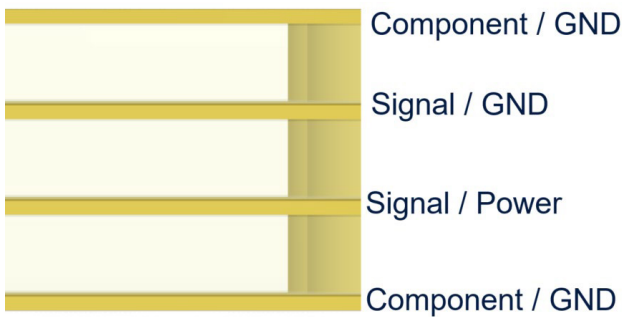

### 11.1. Antenna placement

The best position for the antenna is in the corner of the short side of the PCB. This allows the longer side of the PCB to be a ground plane, a long ground plane improves the antenna's efficiency. The antenna requires clearance ideally in 5 spatial directions as shown below. Where this cannot be achieved you should keep as many clear as possible to a minimum of 3. Please note performance will degrade with fewer clearances.

The Antenova placement tool can be used to advise on antenna placement, see: <https://blog.antenova.com/intelligent-antenna-selection-and-placement-tool-antenova>

Correct

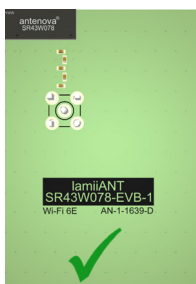

Incorrect

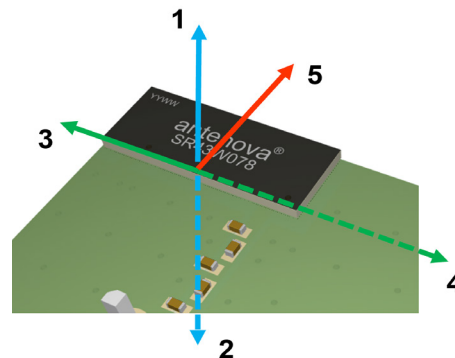
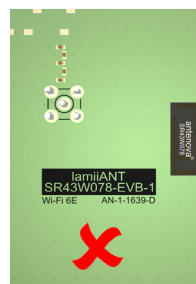

### 11.2. Host PCB layout

The host PCB must be designed using the PCB footprint shown with the correct clearances. An example of the PCB layout shows the antenna footprint. Please note this clearance area is critical to the performance of the antenna and must be applied through all layers of the PCB.

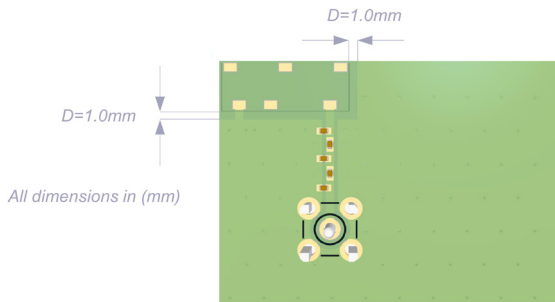

All dimensions in (mm)

### 11.3. Host PCB clearance

The diagram below shows the antenna footprint and clearance through all layers on the PCB. Only the antenna pads and connections to feed and GND are present within this clearance area.

Placement of components and GND with traces adjacent to the antenna should maintain a minimum clearance of 10mm from either side. The antenna should therefore be placed in the corner to only have one side affected.

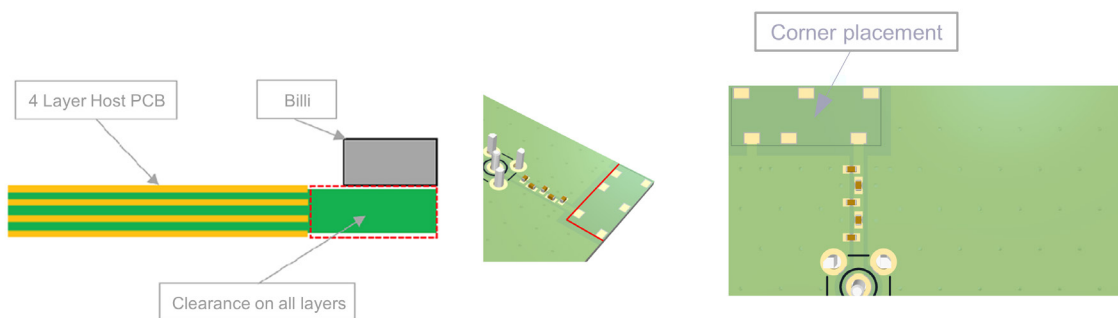

## 12. Reference board

A reference board is used for evaluating the antenna SR43W078 and it includes a SMA female connector. (part number SR43W078-EVB-1)

To order a reference board please see [antenova.com](http://antenova.com)



Top view

Back view

### 12.1. Reference board matching circuit

DESIGNATOR	TYPE	VALUE	DESCRIPTION
C1, C2	Not Fitted		
C3	Capacitor	15.0pF	Murata GJM15 series
C4	Capacitor	0.3pF	Murata GJM15 series
L1	Inductor	0.9nH	Murata LQG15 series

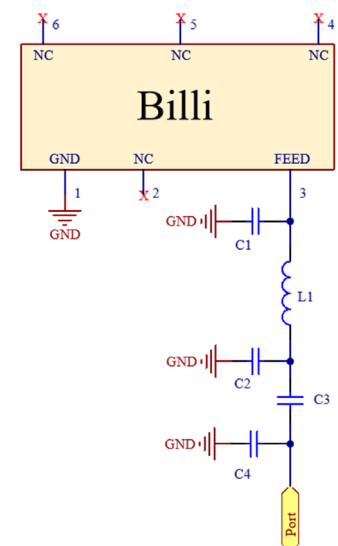

## 13. Soldering

---

This antenna is suitable for lead free soldering. The reflow profile should be adjusted to suit the device, oven and solder paste, while observing the following conditions:

- For leaded soldering, the maximum temperature should not exceed 240 °C.
- For lead free soldering, a maximum temperature of 255 °C for no more than 20 seconds is permitted.
- The antenna should not be exposed to temperatures exceeding 120 °C more than 3 times during the soldering process.

## 14. Hazardous material regulation conformance

---

The antenna has been tested to conform to RoHS and REACH requirements. A certificate of conformance is available from Antenova's website.

## 15. Packaging

---

### 15.1. Optimal storage conditions

---

TEMPERATURE	-10°C to 40°C
HUMIDITY	Less than 75% RH
SHELF LIFE	24 Months
STORAGE PLACE	Away from corrosive gas and direct sunlight
PACKAGING	Reels should be stored in unopened sealed manufacturer's plastic packaging.
MSL LEVEL	1

Note: Storage of open reels of antennas is not recommended due to possible oxidization of pads on antennas. If short term storage is necessary, then it is highly recommended that the bag containing the antenna reel is re-sealed and stored in conditions as described in the table above.

The shelf life of the antenna is 2 years provided the factory seal on the package has not been broken.

15.2. Tape characteristics

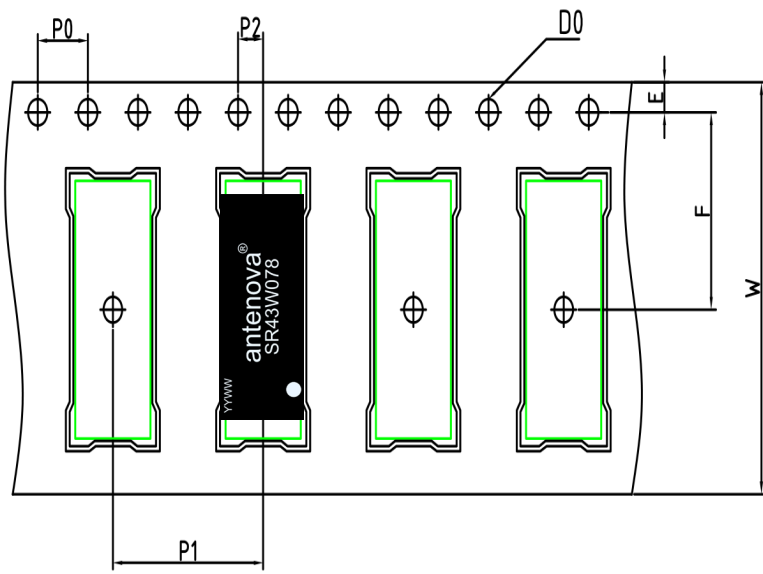

P0	P1	P2	D0
4.00 ± 0.1	12.00 ± 0.1	2.00 ± 0.1	1.55 ± 0.1

E	F	W
1.75 ± 0.1	11.50 ± 0.1	24.00 ± 0.3

All dimensions in (mm)

QUANTITY	LEADING SPACE	TRAILING SPACE
1000 pcs / reel	25 blank antenna holders	25 blank antenna holders

15.3. Reel dimensions

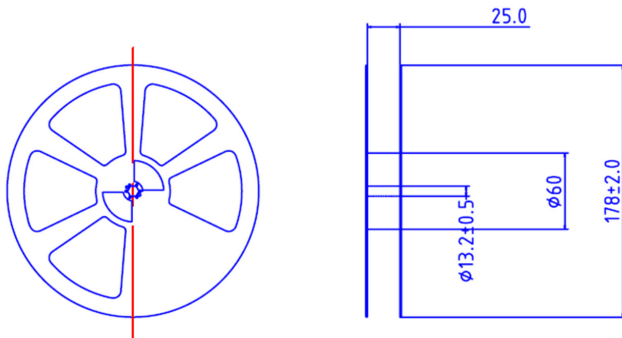

ANTI-STATIC

REEL DIMENSION	Type	Color	Size	Hub
	PS	Black	φ178	φ60

All dimensions in (mm)

15.4. Box dimensions

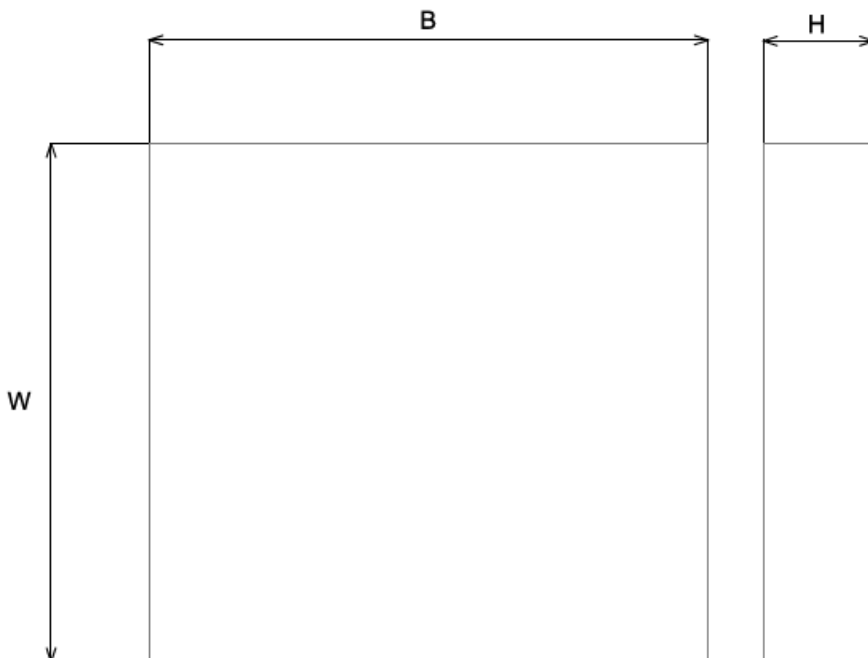

WIDTH (W)	BREADTH (B)	HEIGHT (H)
203mm	188mm	40mm

15.5. Bag properties

---

Reels are supplied in protective plastic packaging.

15.6. Reel label information

---



Quality statements

Antenova’s products conform to REACH and RoHS legislation. For our statements regarding these and other quality standards, please see antenova.com.



Antenova reserves all rights to the contents of this document. Antenova gives no warranties based solely on the accuracy or completeness of the contents of this document and reserves the right to make changes to the specifications of the products described herein at any time and without notice.

Datasheet version

1.01 released Oct 31 2022

# Antenna design, integration and test resources

Product designers – the details contained in this datasheet will help you to complete your embedded antenna design. Please follow our technical advice carefully to obtain optimum antenna performance.

We aim to support our customers to create high performance wireless products. You will find a wealth of design resources, calculators and case studies to aid your design on our website.

Antenova's design laboratories are equipped with the latest antenna design tools and test chambers. We provide antenna design, test and technical integration services to help you complete your design and obtain the required certifications.

If you cannot find the antenna you require in our product range, please contact us to discuss creating a custom antenna to meet your exact requirements.

Share knowledge with RF experts around the world.

**ask.antenova** is a global forum for designers and engineers working with wireless technology.

[VISIT ASK.ANTENOVA](https://ask.antenova.com)

Visit [antenova.com](https://www.antenova.com)

Order antenna samples and evaluation boards, and read our antenna resources

[VISIT ANTENOVA.COM](https://www.antenova.com)

Request a volume quotation for antennas:

[sales@antenova.com](mailto:sales@antenova.com)

Global headquarters

**Antenova Ltd, 2nd Floor Titan Court, 3 Bishop Square, Hatfield, AL10 9NA**

**+44 (0) 1707 927589**