

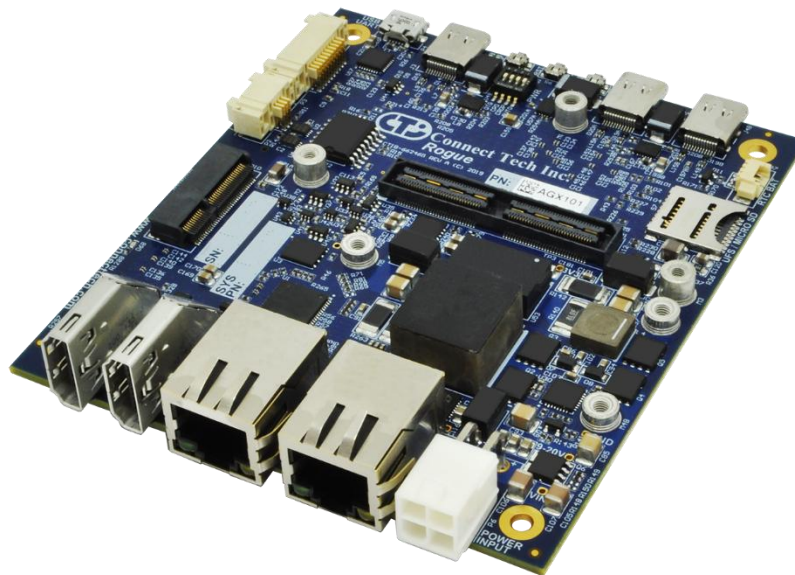

Connect Tech Inc.
Embedded Computing Experts

USERS GUIDE



Rogue – NVIDIA® Jetson AGX Xavier™ Carrier

CTIM-00504 Revision 0.06 2025-09-29



CONNECT TECH
www.connecttech.com
support@connecttech.com

CONNECT TECH INC. | 489 CLAIR RD. W., GUELPH, ON N1L 0H7 CANADA | TEL: +1.519.836.1291 | TOLL: 800.426.8979

TABLE OF CONTENTS

Table of Contents	2
Preface	4
Disclaimer	4
Customer Support Overview	4
Contact Information	4
Limited Product Warranty.....	5
Copyright Notice	5
Trademark Acknowledgment	5
ESD Warning	6
Revision History	6
Introduction	7
Product Features and Specifications.....	8
Part Numbers / Ordering Information	9
Product Overview	11
Block Diagram	11
Board (Top Side).....	12
Board (Back Side).....	13
Connector Summary & Locations.....	14
Jumper Summary & Locations.....	14
LED Summary.....	14
Detailed Feature Description	16
LED Locations	16
Connector and Switch Locations - Module Side.....	17
Jetson AGX Xavier™ Board-to-Board Carrier Connector.....	18
M.2 M-Key – NVMe.....	18
Fan Connector (5V).....	19
CAN Bus TERM enable switch.....	19
Connector and Switch Locations – User Interface Side	20
USB UART Debug console – Micro USB-AB.....	21
USB 3.1/OTG Type C	21
USB 3.1 Type C	22
RTC Battery.....	22
MISC I/O Connector	23
CAN Bus Connector.....	24
CAMERA Expansion Connector.....	24
M.2 E-Key – WiFi and Bluetooth Expansion port	27
Fan Connector (12V).....	27
External Switch Access Connector.....	28
Micro SD/UFS Card Expansion port.....	28
HDMI Video Outputs	29
GBE RJ45 Connectors.....	29
POWER Connector.....	30
POWER Mode Select Switch	31
Push Button Switches	32
Typical Installation	32

Software	32
Force Recovery Mode	33
Power Consumption.....	33
Cables.....	34
Mechanical Drawings & Models.....	35
Thermal Options.....	35
Passive Heatsink (XHG305)	35
Active Heatsink (XHG306).....	35
Assembly drawings	36
AGX101-01 Example (No Heatsink)	36
AGX101-12 Example (Active Heatsink).....	37
AGX101-18 Example (Passive Heatsink)	38

PREFACE

Disclaimer

The information contained within this user’s guide, including but not limited to any product specification, is subject to change without notice.

Connect Tech assumes no liability for any damages incurred directly or indirectly from any technical or typographical errors or omissions contained herein or for discrepancies between the product and the user’s guide.

Customer Support Overview

If you experience difficulties after reading the manual and/or using the product, contact the Connect Tech reseller from which you purchased the product. In most cases the reseller can help you with product installation and difficulties.

In the event that the reseller is unable to resolve your problem, our highly qualified support staff can assist you. Our support section is available 24 hours a day, 7 days a week on our website at: <https://connecttech.com/support/resource-center/>. See the contact information section below for more information on how to contact us directly. Our technical support is always free.

Contact Information

Contact Information	
Mail/Courier	Connect Tech Inc. Technical Support 489 Clair Rd. W. Guelph, Ontario Canada N1L 0H7
Contact Information	sales@connecttech.com support@connecttech.com www.connecttech.com/ Toll Free: 800-426-8979 (North America only) Telephone: +1-519-836-1291 Facsimile: 519-836-4878 (on-line 24 hours)
Support	Please go to the Connect Tech Resource Center for product manuals, installation guides, device drivers, BSPs and technical tips. Submit your technical support questions to our support engineers. Technical Support representatives are available Monday through Friday, from 8:30 a.m. to 5:00 p.m. Eastern Standard Time.

Limited Product Warranty

Connect Tech Inc. provides a one-year Warranty for this product. Should this product, in Connect Tech Inc.'s opinion, fail to be in good working order during the warranty period, Connect Tech Inc. will, at its option, repair or replace this product at no charge, provided that the product has not been subjected to abuse, misuse, accident, disaster or non-Connect Tech Inc. authorized modification or repair.

You may obtain warranty service by delivering this product to an authorized Connect Tech Inc. business partner or to Connect Tech Inc. along with proof of purchase. Product returned to Connect Tech Inc. must be pre-authorized by Connect Tech Inc. with an RMA (Return Material Authorization) number marked on the outside of the package and sent prepaid, insured and packaged for safe shipment. Connect Tech Inc. will return this product by prepaid ground shipment service.

The Connect Tech Inc. Limited Warranty is only valid over the serviceable life of the product. This is defined as the period during which all components are available. Should the product prove to be irreparable, Connect Tech Inc. reserves the right to substitute an equivalent product if available or to retract the Warranty if no replacement is available.

The above warranty is the only warranty authorized by Connect Tech Inc. Under no circumstances will Connect Tech Inc. be liable in any way for any damages, including any lost profits, lost savings or other incidental or consequential damages arising out of the use of, or inability to use, such product.

Copyright Notice

The information contained in this document is subject to change without notice. Connect Tech Inc. shall not be liable for errors contained herein or for incidental consequential damages in connection with the furnishing, performance, or use of this material. This document contains proprietary information that is protected by copyright. All rights are reserved. No part of this document may be photocopied, reproduced, or translated to another language without the prior written consent of Connect Tech, Inc.

Copyright © 2021 by Connect Tech, Inc.

Trademark Acknowledgment

Connect Tech, Inc. acknowledges all trademarks, registered trademarks and/or copyrights referred to in this document as the property of their respective owners. Not listing all possible trademarks or copyright acknowledgments does not constitute a lack of acknowledgment to the rightful owners of the trademarks and copyrights mentioned in this document.

ESD Warning



Electronic components and circuits are sensitive to ElectroStatic Discharge (ESD). When handling any circuit board assemblies including Connect Tech COM Express carrier assemblies, it is recommended that ESD safety precautions be observed. ESD safe best practices include, but are not limited to:

- Leaving circuit boards in their antistatic packaging until they are ready to be installed.
- Using a grounded wrist strap when handling circuit boards, at a minimum you should touch a grounded metal object to dissipate any static charge that may be present on you.
- Only handling circuit boards in ESD safe areas, which may include ESD floor and table mats, wrist strap stations and ESD safe lab coats.
- Avoiding handling circuit boards in carpeted areas.
- Try to handle the board by the edges, avoiding contact with components.

REVISION HISTORY

Revision	Date	Changes
0.00	2019-04-01	Initial Release
0.01	2019-05-17	Updated with assembly drawings, board photos, connector details and detailed feature descriptions
0.02	2019-08-26	Added power consumption numbers, RTC connector section, LED summary, standoff thread sizes for M.2, camera expansion screw size, and corrected P12 pinout.
0.03	2019-09-24	Corrected max voltage input
0.04	2021-06-17	Updated Template & Address, Updated Fan Connector (12V), Updated XHG306 3D Model Images, Updated Misc. I/O Connector
0.05	2022-12-01	Added note on 5V fan connector removal on AGX111
0.06	2025-09-29	Updated GPIO usage reference link

INTRODUCTION

Connect Tech's Rogue (AGX101) is a full featured NVIDIA® Jetson AGX Xavier™ module carrier board. This carrier board for AGX Xavier™ is specifically designed for commercially deployable platforms, and has an extremely small footprint of 92mm x 105mm.

The Rogue provides access to an impressive list of latest generation interfaces on the AGX Xavier™ while adding additional interfaces of 3x USB 3.1, 2x GbE, 2x HDMI and a locking Mini-Fit Jr. input power connector.

Rugged camera add-on expansion boards will also be available for use with the Rogue to interface directly with the AGX Xavier™ high density MIPI CSI interfaces.

Product Features and Specifications

Specifications	
NVIDIA® GPU SoC Module Compatibility	NVIDIA® Jetson AGX Xavier™
Networking	2x Gigabit Ethernet (RJ45) <ul style="list-style-type: none"> - 1 port from RGMII PHY (direct from module) - 1 port from a PCIe I210 MAC/PHY
Display Output	2x HDMI 1.4a (Type A)
Camera Input	6x two lane MIPI CSI-2 or 4x four lane MIPI CSI-2 using a 120 pin (dev kit compatible) QSH expansion connection
USB	3x USB 3.1 5Gbps/10Gbps (Type C – OTG mode 1 port) (Note only 2 interfaces can be used at 10Gbps simultaneously)
Storage	2x M.2 Key-M (NVMe) expansion slot (4 lane PCIe Gen 3) 1x microSD or UFS card slot
UART	2x @3.3V UART1 and UART2 1x USB based Debug UART3 (microUSB AB connector)
I2C/SPI	1x @3.3V I2C 1x @3.3V SPI
CAN Bus	2x CAN 2.0b Isolated Ports
GPIO	4x @3.3V GPIO (direct from module)
User Expansion	1x M.2 Key-E expansion slot (1 lane PCIe Gen 3, USB 2.0) For WiFi/Bluetooth modules
Input Power	9-19V DC Wide Input Power (4 pin Mini-fit Jr Connector)
PCB / Electronics Mechanical Information	92mm x 105mm
Operating Temperature (Carrier Board Only)	-40°C to +85°C (-40°F to +185°F)

Part Numbers / Ordering Information

Part Number				
SKU	AGX Xavier™ Module Included	Heat Sink Options	WiFi Bluetooth Options	SSD Options
AGX101	None	None	None	None
AGX101-01	Yes	None	None	None
AGX101-02	Yes	None	None	1x 1TB SSD Installed
AGX101-03	Yes	None	None	2x 1TB SSDs Installed
AGX101-04	Yes	None	WiFi/BT Module Installed	None
AGX101-05	Yes	None	WiFi/BT Module Installed	1x 1TB SSD Installed
AGX101-06	Yes	None	WiFi/BT Module Installed	2x 1TB SSDs Installed
AGX101-07	Yes	CTI Active Thermal Installed	None	None
AGX101-08	Yes	CTI Active Thermal Installed	None	1x 1TB SSD Installed
AGX101-09	Yes	CTI Active Thermal Installed	None	2x 1TB SSDs Installed
AGX101-10	Yes	CTI Active Thermal Installed	WiFi/BT Module Installed	None
AGX101-11	Yes	CTI Active Thermal Installed	WiFi/BT Module Installed	1x 1TB SSD Installed
AGX101-12	Yes	CTI Active Thermal Installed	WiFi/BT Module Installed	2x 1TB SSDs Installed
AGX101-13	Yes	CTI Passive Thermal Installed	None	None
AGX101-14	Yes	CTI Passive Thermal Installed	None	1x 1TB SSD Installed
AGX101-15	Yes	CTI Passive Thermal Installed	None	2x 1TB SSDs Installed

AGX101-16	Yes	CTI Passive Thermal Installed	WiFi/BT Module Installed	None
AGX101-17	Yes	CTI Passive Thermal Installed	WiFi/BT Module Installed	1x 1TB SSD Installed
AGX101-18	Yes	CTI Passive Thermal Installed	WiFi/BT Module Installed	2x 1TB SSDs Installed

PRODUCT OVERVIEW

Block Diagram

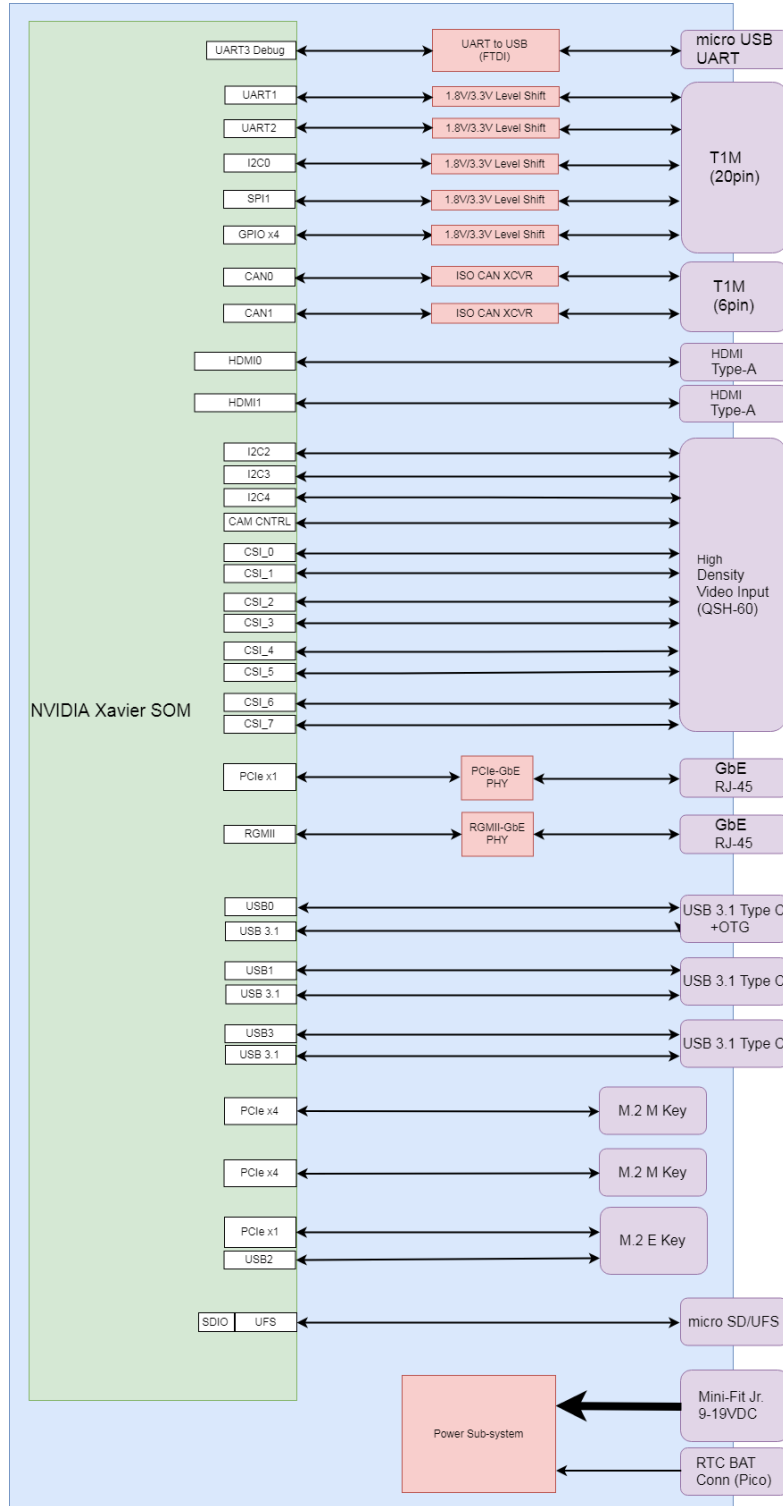

Board (Top Side)

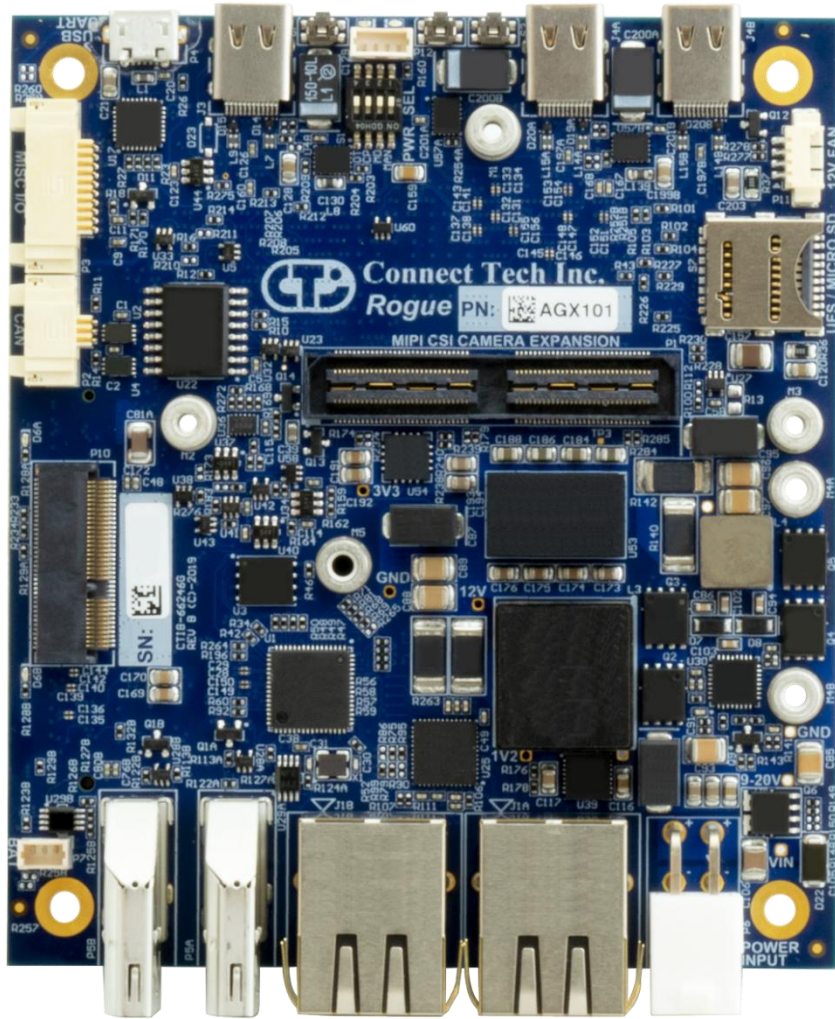

Board (Back Side)



Connector Summary & Locations

Designator	Description
P9	Jetson AGX Xavier™ connector
J2A, J2B	M.2 M-Key (NVMe) connector
P8	5V Fan Connector – for Dev kit fan support
P4	USB UART Debug Console connector
J3	USB 3.1 device port and OTG programming port connector
J4A, J4B	USB 3.1 device ports
P3	MISC I/O connector
P2	CAN Bus Connector
P1	MIPI Camera Expansion connector
P10	M.2 E-Key connector
P11	12V Fan connector
P12	External Switch Access connector
S7	Micro SD or UFS Card Expansion port (Push/Pull)
P5A, P5B	HDMI Display output connectors
J1A, J1B	RJ45 GbE connectors
P6	Input Power connector
P7	RTC Battery connector

Jumper Summary & Locations

Designator	Description
S1	Power Option control dip switches
S2	CAN Bus Termination control dip switches
S3	Power ON momentary switch
S5	Force Recovery momentary switch
S6	Reset momentary switch

LED Summary

Designator	Description
D6A	M.2 connector (J2A) activity
D6B	M.2 connector (J2B) activity

D9	Input Power is good
D10	System Power is good and system is powering on (booting up). In manual power on mode (via dip switch), this light will power on only after the power button has been pushed. Since the typical default mode is auto power on, the light will come on as on the system starts to boot.

DETAILED FEATURE DESCRIPTION

LED Locations

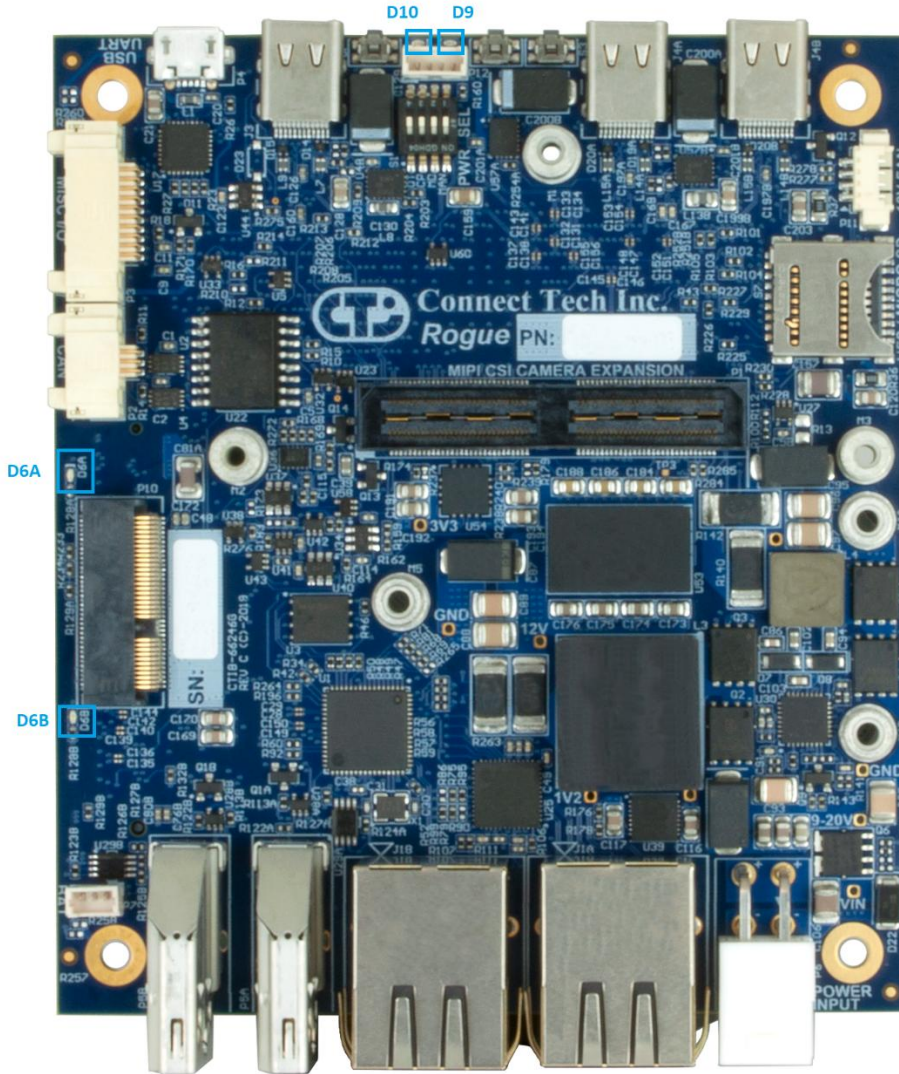

Connector and Switch Locations - Module Side

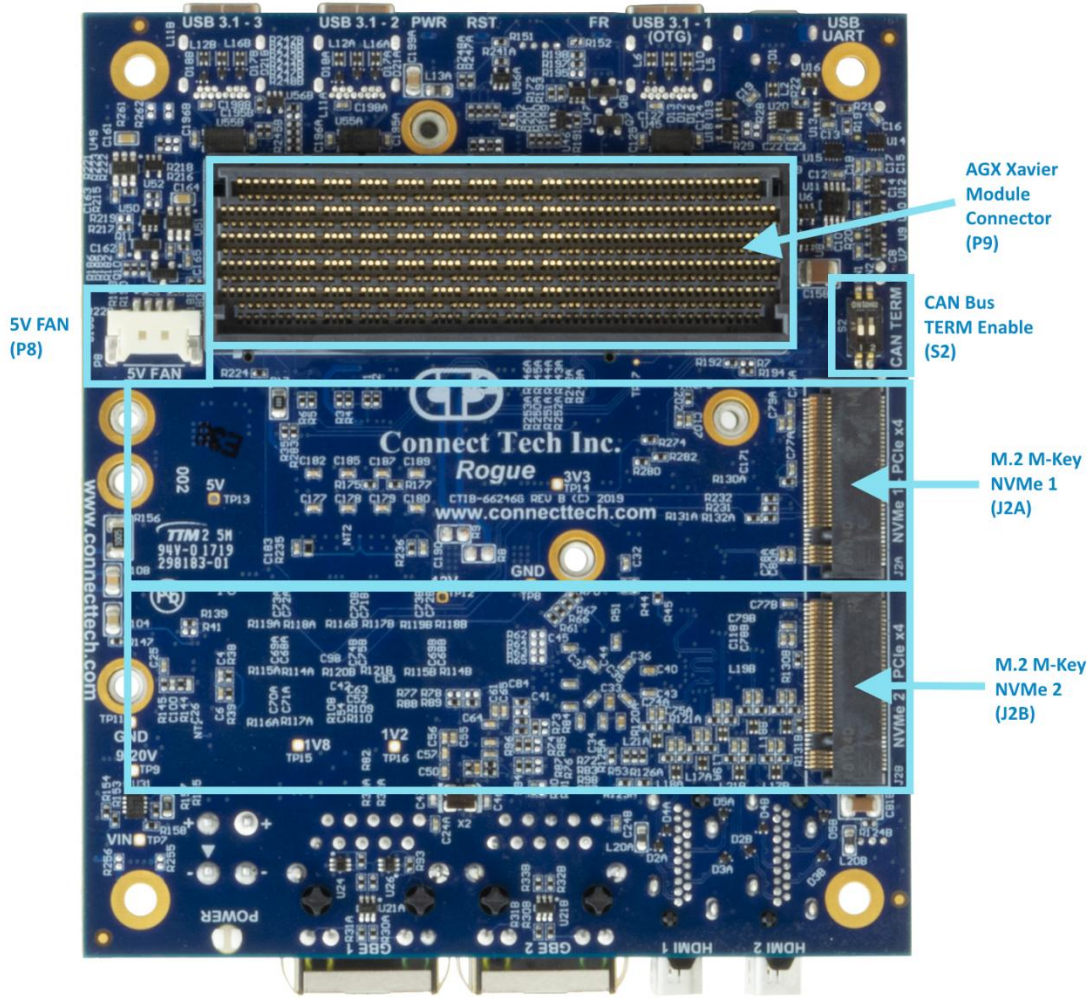

Jetson AGX Xavier™ Board-to-Board Carrier Connector

With the NVIDIA® Jetson AGX Xavier™, the processor and chipset are implemented on the module.

Function	NVIDIA® Jetson AGX Xavier™ Module Interface	
Location	P9	
Type	Molex Mirror Mezz™ Connector	
Connector	Part Number: 203456-0003 Manufacturer: Molex	
Mating Connector	Same as above.	
Pinout	Refer to NVIDIA® Jetson AGX Xavier™ System-on-Module datasheet and OEM design guide for pinout details	

M.2 M-Key – NVMe

Function	NVMe Storage (x2 PCIe Gen 3)	
Location	J2A, J2B	
Type	2280 M.2 M-key 3.2mm mating height with M3 mounting standoff.	
Connector	Part Number: 1-2199119-5 Manufacturer: TE	
Mating Connector	N/A	
Pinout	M.2 Specification M-Key pin assignment.	
Notes	Interface is x4 PCIe Gen 3. SATA is not supported. PCIe based devices only.	

Fan Connector (5V)

Function	Fan control for Dev Kit	
Location	P8	
Type	4 pin Panel-mate	
Connector	Part Number: 53780-0470 Manufacturer: Molex	
Mating Connector	Part Number: 51146-0400 (housing), 50641-8xxx (contact) Manufacturer: Molex	
Pinout	Pin	Description
	1	GND
	2	5V Power
	3	TACH from fan to module
	4	PWM from module to fan
Notes	<p>Installation note: Fan connector must be installed before an NVMe card is installed in slot J2A (NVMe 1) to avoid interference.</p> <p>This Fan connection is specifically for 5V fans ONLY, and will not properly work with a 12V Fan (see P11 below for 12V option).</p> <p>This connector was removed on AGX111.</p>	



CAN Bus TERM enable switch

Function	Enable CAN Bus termination on CAN1 and CAN2			
Location	S2			
Type	2 SPST dip switch			
Default	Product is shipped with both Terminations DISABLED. Only add the termination if the unit is an end point of any CAN Bus connection, otherwise leave disabled.			
Pinout	Switch	Description	ON	OFF
	S2-1	CAN Bus 1 TERM Enable	120 ohm	No TERM
	S2-2	CAN Bus 2 TERM Enable	120 ohm	No TERM



Connector and Switch Locations – User Interface Side

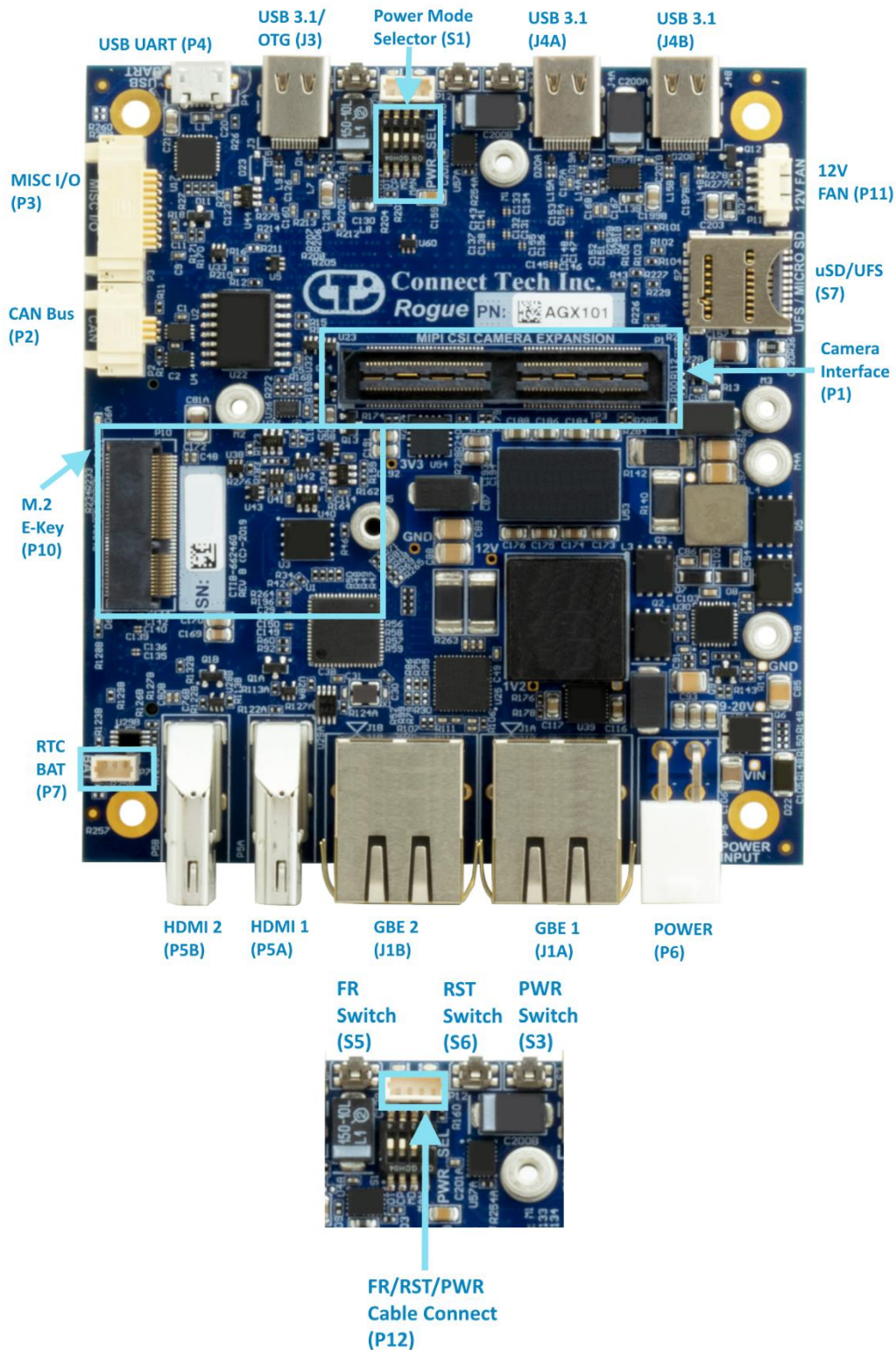

USB UART Debug console – Micro USB-AB

Function	USB UART Debug console	
Location	P4	
Type	5 Pin USB Micro AB connector	
Connector	Part Number: 47589-0001 Manufacturer: Molex	
Mating Cable	Any standard Micro USB to USB Type A	
Notes	This interface utilizes an FTDI USB to Serial device on board to allow access to the Jetson AGX Xavier™ Serial debug console using any Micro USB to USB A cable and any PC with a USB interface and serial terminal program.	

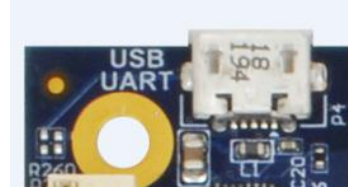

USB 3.1/OTG Type C

Function	USB 3.1 device port, OTG programming port	
Location	J3	
Type	24 Pin USB Type C	
Connector	Part Number: 632723300011 Manufacturer: Wurth	
Mating Cable	Any Standard Type C interface cable or device ** Note this port only supports USB devices, it does not include a display interface **	
Notes	This interface doubles as both a standard DFP (Downward facing port) USB 3.1 port to support USB 3.1 devices and the Jetson AGX Xavier™ Programming (flashing) interface port. The port is capable of up to USB 3.1 Gen 2 speeds in normal operation. The USB 2.0 portion of the interface doubles as the OTG programming port when the FORCE RECOVERY function is applied at startup. The power to the port is disabled so an external PC connection is possible in order to reprogram the module using Jetpack. Maximum power available on this output is 1.5A @5V.	

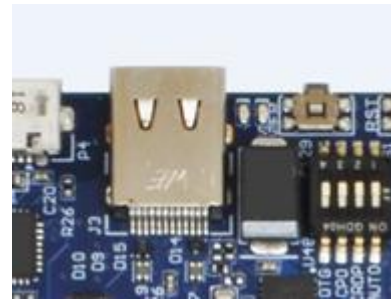

USB 3.1 Type C

Function	USB 3.1 device ports	
Location	J4A, J4B	
Type	24 Pin USB Type C	
Connector	Part Number: 632723300011 Manufacturer: Würth	
Mating Connector	Any Standard Type C interface cable or device ** Note this port only supports USB devices, it will not work as a display interface **	
Notes	<p>These interfaces are both standard DFP (Downward facing port) USB 3.1 Gen 2 capable ports used to support USB peripheral devices. Display devices or devices requiring 20V power modes are NOT supported.</p> <p>These ports are capable up to USB 3.1 Gen 2 (10G) speeds in normal operation. Note that only any 2 interfaces can be used at 10Gbps simultaneously.</p> <p>The power available from either of these ports is 3A @5V. However ONLY ONE port can be loaded at up to 3A at a time. Both will support simultaneous 1.5A loads. Overloading both of these ports will result in system power overload and the Rogue will shut down prematurely.</p>	



RTC Battery

The Rogue allows for an external RTC battery to be connected. This battery should be a 3V DC battery, and it will hold settings including date and time. For further information about RTC battery selection and life time estimation, see Application Note 00009: <https://connecttech.com/pdf/CTIN-00009.pdf>

Function	RTC Battery Connector		
Location	P7		
Type	3 pin PicoBlade (vertical)		
Connector PN	53047-0310 - Manufacturer: Molex		
Mating PN	51021-0300 - Manufacturer: Molex		
Pinout	Pin	Signal	Description
	1	+3V	RTC Battery Voltage Input
	2	NC	No Connect
	3	GND	Ground/Return



MISC I/O Connector

Function	2x Serial (TTL), 1x I2C, 1x SPI, 4x GPIO	
Location	P3	
Type	20 Pin	
Connector	Part Number: T1M-10-GF-DH Manufacturer: Samtec	
Mating Cable	S1SD-10-28-GF-xxx	
Pinout	Connector Pins	Description
	1	UART1 TX
	2	UART2 TX
	3	UART1 RX
	4	UART2 RX
	5	I2C SCL
	6	UART2 RTS#
	7	I2C SDA
	8	UART2 CTS#
	9,10,11,12	GND
	13	GPIO0 (GPIO12)
	14	SPI CLK
	15	GPIO1 (GPIO13)
	16	SPI MOSI
	17	GPIO2 (GPIO14)
	18	SPI MISO
	19	GPIO3 (GPIO17)
	20	SPI CS#
Notes	This interface provides 3.3V capable generic I/O including: <ul style="list-style-type: none"> • UART1 under /dev/ttyTHS0 UART2 under /dev/ttyTHS1 • I2C under i2c-0 • SPI under /dev/spidev0.0 • x4 GPIO under gpiochip2 For more information on I2C usage, please click here . For more information on GPIO usage, please click here .	

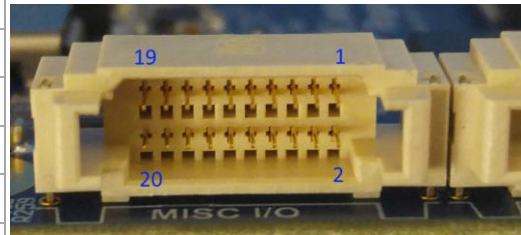

CAN Bus Connector

Function	2x Isolated CAN Bus	
Location	P2	
Type	6 Pin	
Connector	Part Number: T1M-03-GF-DH Manufacturer: Samtec	
Mating Cable	S1SD-03-28-GF-xxx	
Pinout	Connector Pins	Description
	1	CAN0_H
	2	CAN1_H
	3	CAN0_L
	4	CAN1_L
	5	GND_ISO
6	GND_ISO	
Notes	This interface provides two isolated CAN Bus interfaces.	

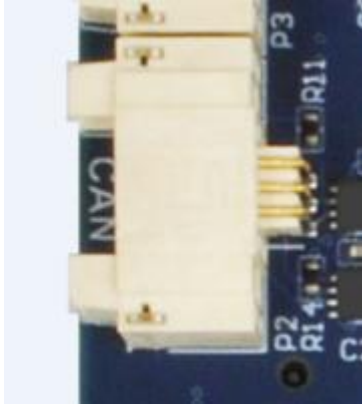
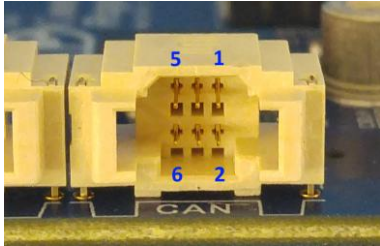
CAMERA Expansion Connector

Function	8 MIPI CSI-2 Camera Interfaces + I2C and GPIO Control			
Location	P1			
Type	120 Pin QSH with M2.5 mounting standoffs			
Default	Part Number: QSH-060-01-L-D Manufacturer: Samtec			
Mating Connector	QTH			
Pinout	Pin #	Description		Pin #
	1	CSIO_D0_P	CSI1_D0_P	2
	3	CSIO_D0_N	CSI1_D0_N	4
	5	GND	GND	6
	7	CSIO_CLK_P	CSI1_CLK_P	8
	9	CSIO_CLK_N	CSI1_CLK_N	10
	11	GND	GND	12
	13	CSIO_D1_P	CSI1_D1_P	14

15	CSI0_D1_N	CSI1_D1_N	16
17	GND	GND	18
19	CSI2_D0_P	CSI3_D0_P	20
21	CSI2_D0_N	CSI3_D0_N	22
23	GND	GND	24
25	CSI2_CLK_P	CSI3_CLK_P	26
27	CSI2_CLK_N	CSI3_CLK_N	28
29	GND	GND	30
31	CSI2_D1_P	CSI3_D1_P	32
33	CSI2_D1_N	CSI3_D1_N	34
35	GND	GND	36
37	CSI4_D0_P	CSI6_D0_P	38
39	CSI4_D0_N	CSI6_D0_N	40
41	GND	GND	42
43	CSI4_CLK_P	CSI6_CLK_P	44
45	CSI4_CLK_N	CSI6_CLK_N	46
47	GND	GND	48
49	CSI4_D1_P	CSI6_D1_P	50
51	CSI4_D1_N	CSI6_D1_N	52
53	GND	GND	54
55	+12V	+12V	56
57	+12V	+12V	58
59	CSI5_D0_P	CSI7_D0_P	60
61	CSI5_D0_N	CSI7_D0_N	62
63	GND	GND	64
65	CSI5_CLK_P	CSI7_CLK_P	66
67	CSI5_CLK_N	CSI7_CLK_N	68
69	GND	GND	70
71	CSI5_D1_P	CSI7_D1_P	72
73	CSI5_D1_N	CSI7_D1_N	74
75	I2C3_SCL	NC	76
77	I2C3_SDA	NC (PWM1)	78
79	GND	GND	80
81	+2.8V	+2.8V	82
83	+2.8V	NC	84



	85	NC	NC (PWM2)	86
	87	I2C2_SCL	CAM_MCLK3	88
	89	I2C2_SDA	CAM1_PWDN	90
	91	CAM_MCLK2	CAM1_RST#	92
	93	CAM0_PWDN	CAM_MCLK4	94
	95	CAM0_RST#	NC	96
	97	NC	NC	98
	99	GND	GND	100
	101	NC	1.8V	102
	103	NC	NC	104
	105	I2C4_SCL	NC	106
	107	I2C4_SDA	3.3V	108
	109	NC	3.3V	110
	111	NC	NC	112
	113	NC	NC	114
	115	GND	GND	116
	117	NC	3.3V	118
	119	CAM_AVDD_EN	3.3V	120
Notes	<p>Only 6 of the CSI2 interfaces can be used at once in 2 lane configuration. Only 4 interfaces when using 4 lane configuration.</p> <p>All non-CSI-2 I/O is 1.8V levels.</p> <p>CAUTION! – The 12V pins shown above differ from that of the NVIDIA® dev kit pinout.</p> <p>This 12V power can be used for Camera expansion requirements up to 2A @12V.</p>			

M.2 E-Key – WiFi and Bluetooth Expansion port

Function	M.2 E-Key Expansion port
Location	P10
Type	75 Pin M.2 Connector with M2.5 mounting standoff
Connector	Part Number: 2199230-4 Manufacturer: TE
Mating Cable	N/A
Pinout	As per the M.2 E-Key specification
Notes	This port contains a x1 PCIe Gen 1 interface and one USB 2.0 interface. Support for M.2 2230 sizes only.



Fan Connector (12V)

Function	Fan control for XHG306	
Location	P11	
Type	4 pin PicoBlade (right angled)	
Connector	Part Number: 53261-0471 Manufacturer: Molex	
Mating Connector	Part Number: 51021-0400 (housing), 50058-8000 (contact) Manufacturer: Molex	
Pinout	Connector Pins	Description
	1	GND
	2	12V Power
	3	TACH from fan to module
	4	PWM from module to fan
Notes	Installation note: This Fan connection is specifically for 12V fans ONLY. Forcing a connection of a 5V fan will result in a damaging the card and/or the fan.	

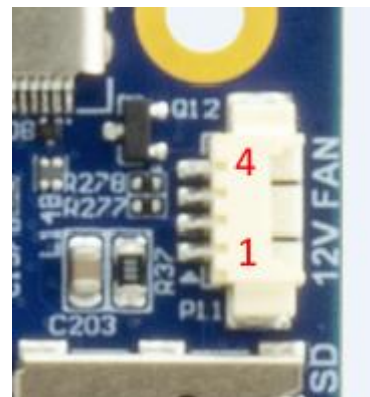

External Switch Access Connector

Function	External Switch Access (Power, Reset, Force Recovery)	
Location	P12	
Type	4 pin PicoBlade (vertical)	
Connector	Part Number: 53047-0410 Manufacturer: Molex	
Mating Connector	Part Number: 51021-0400 (housing), 50058-8000 (contact) Manufacturer: Molex	
Pinout	Connector Pins	Description
	1	GND
	2	Force_Recovery_BTN#
	3	Reset_BTN#
	4	Power_BTN#
Notes	To activate any of the features, momentarily connect the signal the GND provided on the connector using momentary close switches only.	

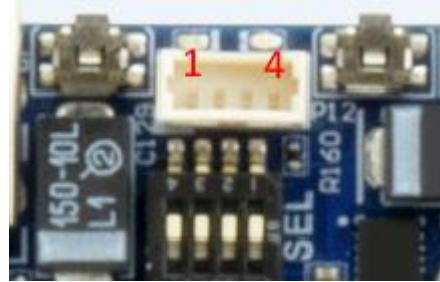

Micro SD/UFS Card Expansion port

Function	Micro SD or UFS Card Expansion
Location	S7
Type	19 Pin Multi card connector
Connector	Part Number: 10101704J6#2A Manufacturer: Amphenol
Mating Cable	N/A
Pinout	As Per the micro SD and UFS Specification



HDMI Video Outputs

Function	HDMI Display Outputs
Location	P5A, P5B
Type	19 Pin Multi card connector
Connector	Part Number: 2013978-1 Manufacturer: TE
Mating Cable	Standard HDMI cable
Pinout	As per the HDMI Specification
Notes	Outputs are capable of a resolution up to 3840x2160 @60Hz. Dual display is supported.



GBE RJ45 Connectors

Function	GBE Network Connectivity
Location	J1A, J1B
Type	8 pin RJ45 with integrated Magnetics
Connector	Part Number: JXD0-0001NL Manufacturer: Pulse
Mating Cable	Standard RJ45 Cat 5e
Pinout	As per the IEEE-802.3 specification
Notes	J1A comes direct from the AGX Xavier™ Module Ethernet port. J1B Comes from the local carrier's PCIe Intel I210 MAC/PHY.

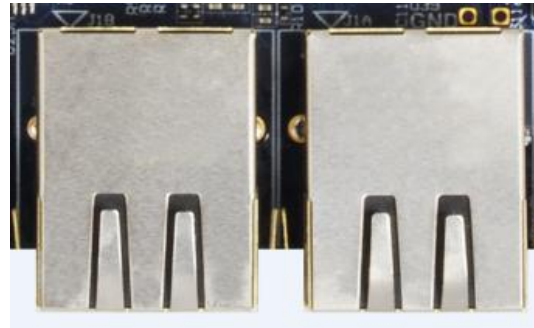

POWER Connector

Function	Input Power	
Location	P6	
Type	4 Pin Molex Mini-Fit Jr.	
Connector	Part Number: 39-30-1042 Manufacturer: Molex	
Mating Cable	ATX 4 pin Mini Fit Jr	
Pinout	Connector Pins	Description
	1	GND
	2	GND
	3	+VIN
	4	+VIN
Notes	Voltage Input Range 9V – 19V input range with input reverse polarity protection. Note that this connector is compatible with a 12V 4pin ATX Power supply connection.	

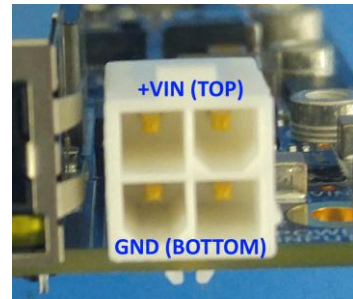

POWER Mode Select Switch

Function		Power Mode selection		
Location	S1			
Type	4 SPST dip switch			
Connector	Product is shipped with all switches OFF, the default is Auto On/Module Controlled mode.			
Mating Cable	Switch	Description	ON	OFF
	S1-1	Auto or Manual Power On (MAN)	Manual Power On	Auto
	S1-2	Module Present Detect (MD) – Debug ONLY	DO NOT USE	Module controlled
	S1-3	Carrier Power On (CP) - Debug ONLY	DO NOT USE	Module controlled
	S1-4	OTG Port Power control (OT) – Debug ONLY	DO NOT USE	Auto
Notes	<p><u>S1-1</u> AUTO Power ON Mode behavior</p> <ol style="list-style-type: none"> 1) Upon applying power the system boots immediately. 2) Upon requesting a Software shutdown from the OS, the system will reboot after the shutdown completes without cycling power. 3) Upon a Power Button Event (> 500 ms but < 10 secs) the system OS will prompt with the Restart/Shutdown pop-up menu (only applicable in the GUI). 4) Upon a Power Button Event (> 10 secs) the system OS will prompt with the Restart/Shutdown menu (only applicable in the GUI). Note that the system will NOT shutdown. <p>Manual Power ON Mode behavior</p> <ol style="list-style-type: none"> 1) Upon applying power the system will sit in standby, awaiting a (> 500ms) Power Button Event. 2) Upon requesting a Software shutdown from the OS, the system will return to standby and await a new Power Button Event (> 500ms). 3) Upon a Power Button Event while operating (> 500 ms but < 10 secs) the system OS will prompt with the Restart/Shutdown menu (only applicable in the GUI). 4) Upon a Power Button Event while operating (> 10 secs) the system will perform a hard shutdown immediately and return to the Power On standby state awaiting a new Power Button Event. 			



Push Button Switches

Function	Power/Reset/Force Recovery Buttons
Location	S3, S6, S5
Type	Momentary Push button micro switches
Function	<p>Power ON switch (S3): a press of >500ms when in manual mode will trigger system to power ON.</p> <p>Reset Switch (S6): a press of >500ms will trigger a full system Reset.</p> <p>Force Recovery (S5): No function during normal operation. Will place the AGX Xavier™ Module into Force Recovery Mode when held during power ON.</p>

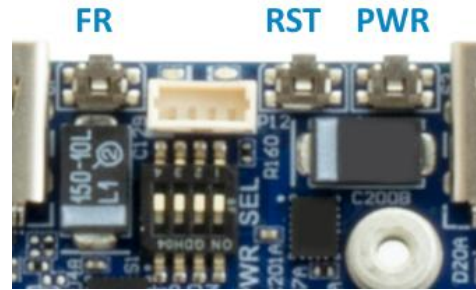

TYPICAL INSTALLATION

1. Ensure all external system power supplies are off.
2. Install the Jetson AGX Xavier™ Module onto the Molex Mirror Mezz™ Connector. Be sure to follow the manufacturer's directions for proper installation of mounting hardware, heatsink/heatspreader, and any other applicable requirements from the manufacturer.
3. Install the necessary cables for application. At a minimum these would include:
 - a) Power cable to the input power connector on the carrier
 - b) HDMI video display cable
 - c) Keyboard and mouse via USB

For additional information on the relevant cables, please see the Cables and Interconnects section of this manual.

4. Connect the Power Cable to the Power Supply.
5. Switch ON the Power Supply. DO NOT power up your system by plugging in live power.

SOFTWARE

For L4T (Linux for Tegra) BSPs and Software Support NVIDIA® Jetson™ AGX Xavier™ please follow this link: <https://connecttech.com/resource-center/l4t-board-support-packages/>

FORCE RECOVERY MODE

The USB 3.1/OTG Port (J3) of the Rogue can be used to reprogram the AGX Xavier™ from another host platform running NVIDIA® Jetpack™.

- 1) Power down the system completely. The system power MUST be OFF, not in suspend or sleep mode.
- 2) Connect the OTG USB port to another host device that will be supplying the new system file.
- 3) Hold down the Force Recovery Button (S5) and then power the board.
- 4) After three (3) seconds release the Recovery button.
- 5) The AGX Xavier™ will show up on the host system USB list as a new NVIDIA® target device.
- 6) After successfully updating the system software, power off the system. A clean power up will revert the OTG port back into host mode.

POWER CONSUMPTION

Below is the theoretical maximum stand-alone power consumption of the Rogue Carrier with the AGX Xavier™ Module installed. (System power)

Theoretical Maximum System power	Watts
Theoretical absolute maximum total with AGX Xavier™ Module (30W Power Mode), 2x NVMe, 2x GbE, 3x USB 3.1 Gen 2 fully loaded (1x 3A, 2x 1.5A), 3x Camera (4 lane).	75W

The typical power consumption will vary depending on the application and use case.

Theoretical Maximum System power	Watts
Idle, AGX Xavier™ (10W Power Mode), 1x display	7.5W
Idle, AGX Xavier™ (10W Power Mode), 2x NVMe, 2x GbE, 1x WiFi/BT modules, dual display, 3x USB 3.1 Gen 2 to four port hubs, uSD Card, Serial Console.	18W
AGX Xavier™ (30W Power Mode), 1x display running CUDA benchmarks	42W
AGX Xavier™ (30W Power Mode), 2x NVMe, 2x GbE, 1x WiFi/BT modules, dual display, 3x USB 3.1 Gen 2 to four port hubs, uSD Card, Serial Console. Running CUDA, and system benchmarks.	64W

CABLES

Part No.	Description
CBG310	USB Type-C Male to Type-A Female Cable
CBG311	USB Type-C Male to Type-A Male Cable
CBG247	USB Micro-B Male to Type-A Male cable (UART Coms)
CBG312	MISC IO Breakout Cable (Flying Leads)
CBG313	CAN IO Breakout Cable (Flying Leads)
CBG136	RTC Battery Cable Assembly
CKG064	Rogue Full Cable Kit Including all of the above
MSG085	AC/DC PSU Brick 19V/120W + adapter
CBG314	Input Power Cable (Discrete Wire) – Included with every AGX101 Carrier.

Cable drawings are available upon request. Send an email request to: support@connecttech.com

MECHANICAL DRAWINGS & MODELS

3D Model is located

https://connecttech.com/ftp/3d_models/AGX101_3D_MODEL.zip

THERMAL OPTIONS

Passive Heatsink (XHG305)

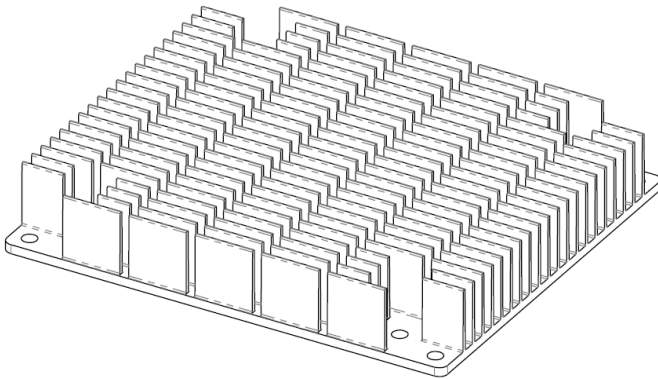

Active Heatsink (XHG306)

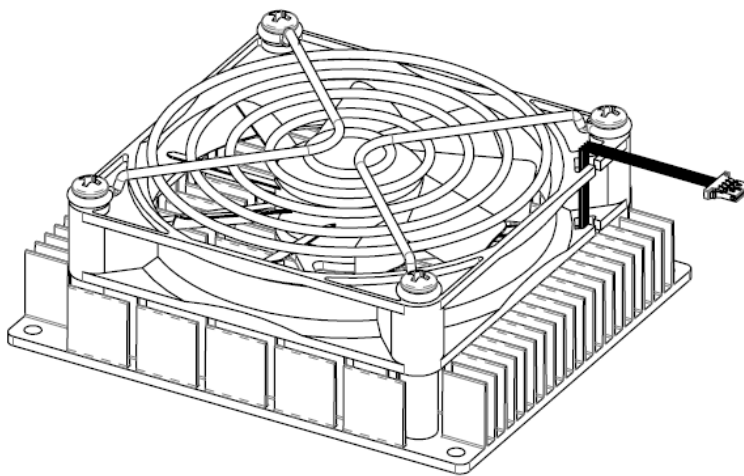

Assembly drawings

AGX101-01 Example (No Heatsink)

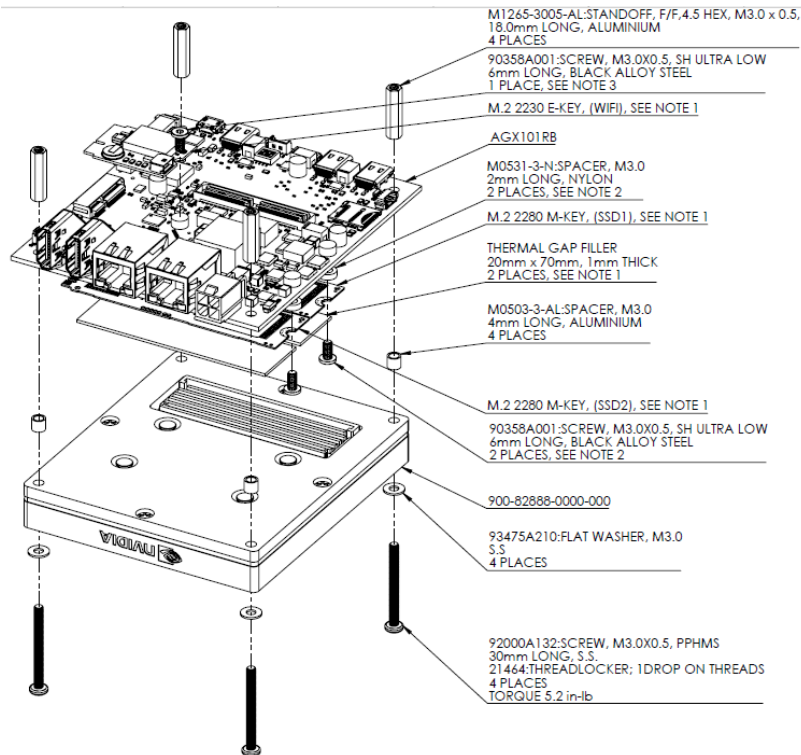
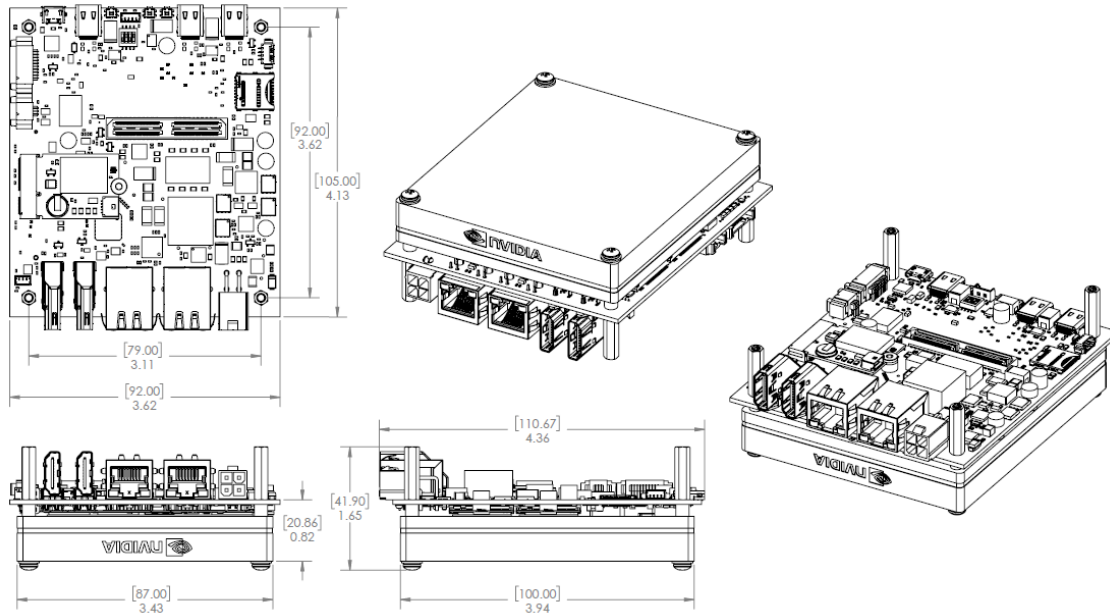

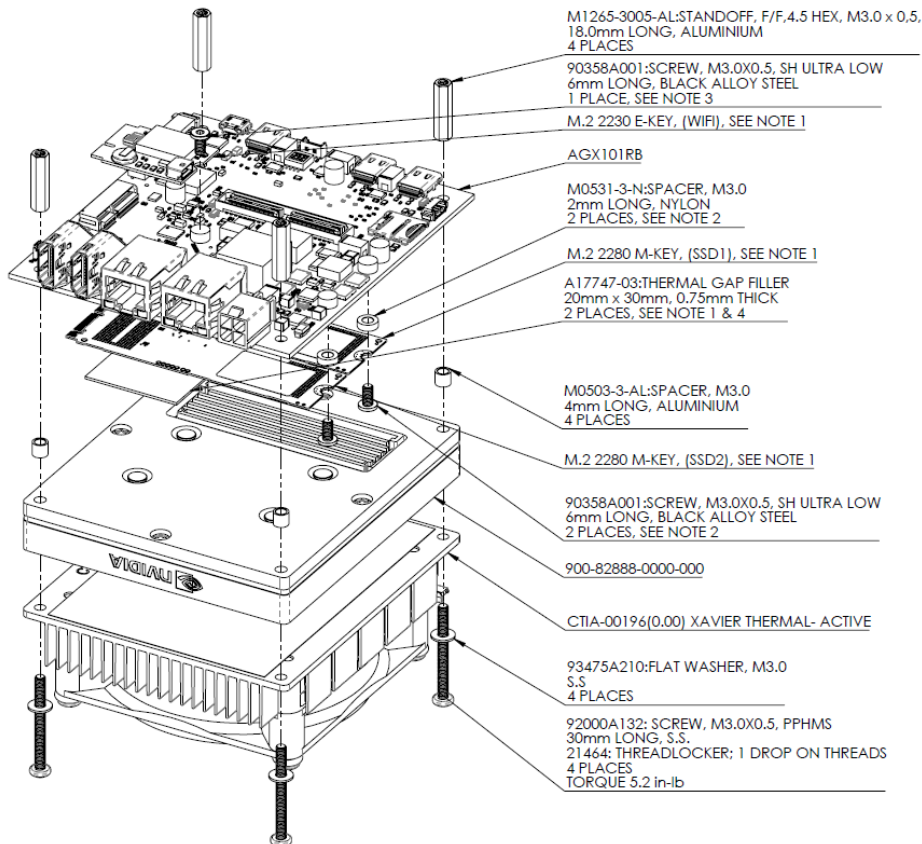
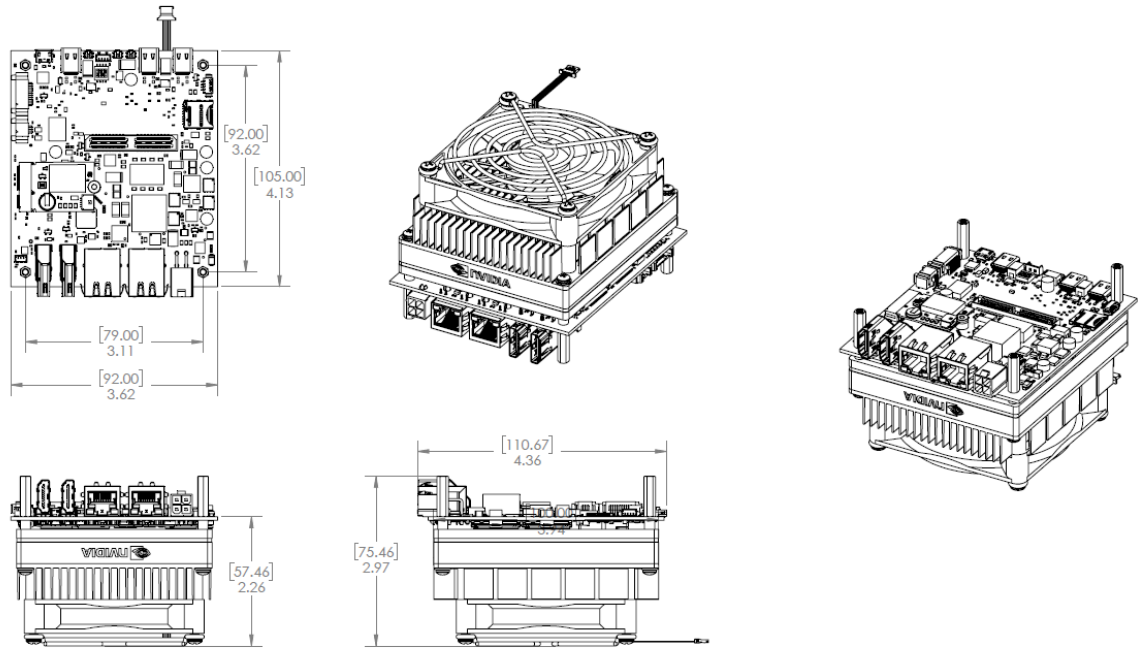
AGX101-12 Example (Active Heatsink)

AGX101-18 Example (Passive Heatsink)
